

Taymor

2014

COMMERCIAL



LOCKS & DEADBOLTS | DOOR CLOSERS | EXIT DEVICES
HOSPITALITY & COMMERCIAL BATHWARE



I'm delighted to introduce our new 2014 catalogue, filled with more new and unique products than ever before.

At Taymor, we continue our commitment to create affordable, well-designed bathware, doorware and homeware that is easy to buy, easy to install, and easy to enjoy. The Taymor team is passionate about bringing thoughtful design, great performance and more affordability than ever to an increasingly broad range of products that meet the design preferences of Canadian homeowners. Our focus on "Suite-ing" – bringing together products whose styles and finishes work together to create seamless style throughout the home – is unchanged; we have even more families of matching and coordinating Bathware, Faucets and Doorware, making it easier than ever for our customers to deliver extraordinary style and value.

We continue to bring unparalleled service excellence to our customers, knowing that YOUR customers rely on you to provide trusted products for their homes and businesses. We are committed to deeply understanding your needs and providing a level of service that exceeds expectations.

Thank you for inspiring us to create products that deliver better style and value than ever before. We look forward to continuing to be your partner in success.

A handwritten signature in black ink that reads "V. Zalkow".

Vivian Zalkow
CEO

TAYMOR COMMERCIAL HARDWARE

WARRANTY

Grade 1 Mortise locks, Cylindrical locks and Deadbolts are warranted to be free from mechanical and workmanship defects for 10 years, unless otherwise stated. Finish warranty is for 1 year.

Grade 2 Cylindrical locks, tubular locks and deadbolts are also warranted to be free from mechanical and workmanship defects for 5 years, unless otherwise stated. Finish warranty is also for 1 year.

Grade 1 Exit Devices are warranted to be free from mechanical and workmanship defects for 5 years, unless otherwise stated. Finish warranty is for 1 year. All other exit devices are warranted to be free from mechanical and workmanship defects for 3 years, and finish warranty for 1 year.

KEYING SERVICES

All retail pack locks are keyed different; all builder pack locks are keyed alike. Taymor offers keying services for all of our locks including: keyed alike, keyed different, master keying, grand master keying, great grand master keying, and construction keying.

FIRE RATINGS

Mortise, Cylindrical, and tubular commercial locks marked "cUL" conform to the 3-hour Fire Test as determined by Underwriters Laboratories of Canada Inc., in the Standard Method For Fire Tests Of Door Assemblies, ULC CAN-ULC-S104-10.

Exit Devices identified as "Fire Rated" and marked "cUL" conform to the 1.5-hour Fire Test as determined by Underwriters Laboratories of Canada Inc., in the Standard Method For Fire Tests Of Door Assemblies, ULC CAN-ULC-S132. Exit Devices identified as "Safety Rated" conform to the operability requirements of non-fire rated Exit Hardware, as defined by ULC CAN-ULC-S132.

Door Closers marked "cUL" conform to the cUL 10C positive pressure requirement as determined by Underwriters Laboratories of Canada Inc., in the Standard Method For Fire Tests for Door Closers, ULC CAN-ULC-S133.

ANSI RATINGS

Commercial Locks, Exit Hardware, or Door Closers identified as meeting either "Gr 1" or "Gr 2" meet or exceed the requirements set forth by BHMA/ANSI (Builders Hardware Manufacturers Association / American National Standards Institute) 156.2. These requirements are determined by rigorous Operational, Strength, Cycle, Security, Material, and Finish Tests.

Regarding the door preparation, installation instructions and templates follow the guidelines set forth in BHMA/ANSI 115.1 and BHMA/ANSI 115.2 for Mortise and Bored Locks respectively.

MAKING THE GRADE



CONTENTS

- 4** Cylindrical Locks
- 8** Mortise Locks for Commercial Applications
- 10** Door Closers
- 13** Exit Hardware
- 17** Architectural Hardware
- 18** Hospitality & Commercial Bathware

CYLINDRICAL LOCKSETS & DEADBOLTS

For multi-unit common area or general commercial application, Taymor's commercial lockset line represents the best value and performance for your 160/161 door prep needs.



GRADE 1 - MAXIMUM DUTY



KNIGHT

- Grade 1 maximum duty cylindrical construction • Meets or exceeds requirements of BHMA/ANSI 156.2 Grade 1 • Meets cUL and UL 3-hour fire rating standards
- 10 year mechanical warranty

DESCRIPTION	ANSI FUNCTION #	SATIN CHROME C26D	CASE QTY
Entry – entrance/office leverset (inside turn button)	F109	32-6953	10
Privacy – restroom leverset (inside turn button)	F76	32-6940	10
Passage – hall/closet leverset	F75	32-6910	10
Storeroom	F86	32-6980	10
Classroom	F84	32-6970	10



NEW! NORMANDY

- Grade 1 maximum duty cylindrical construction • Meets or exceeds requirements of BHMA/ANSI 156.2 Grade 1 • Meets cUL and UL 3-hour fire rating standards
- 10 year mechanical warranty

DESCRIPTION	ANSI FUNCTION #	SATIN STAINLESS STEEL C32D	CASE QTY
Entry – entrance/office leverset (inside turn button)	F109	32-3953	6
Privacy – restroom leverset (inside turn button)	F76	32-3940	6
Passage – hall/closet leverset	F75	32-3910	6
Storeroom	F86	32-3980	6
Classroom	F84	32-3970	6



NEW! GRADE 1 DEADBOLT

- Grade 1 maximum duty cylindrical construction • Meets or exceeds requirements of BHMA/ANSI 156.2 Grade 1 • Meets cUL and UL 3-hour fire rating standards
- 10 year mechanical warranty

DESCRIPTION	SATIN CHROME C26D	CASE QTY
Grade 1 single cylinder deadbolt	32-F780	20
Grade 1 double cylinder deadbolt	32-F790	20

GRADE 2 - HEAVY DUTY



CITADEL

- Grade 2 heavy duty cylindrical construction • Meets or exceeds requirements of BHMA/ANSI 156.2 Grade 2 • Meets cUL and UL 3-hour fire rating standards
- 5 year mechanical warranty

DESCRIPTION	ANSI FUNCTION #	POLISHED CHROME (C26)	SATIN CHROME (C26D)	CASE QTY
Entry – entrance/office leverset (inside turn button)	F109	32-5553C26	32-5553C26D	6
Privacy – restroom leverset (inside push button)	F76	32-5540C26	32-5540C26D	6
Passage – hall/closet leverset	F75	32-5510C26	32-5510C26D	6
Storeroom/Storeroom with clutch mechanism	F86	32-5580C26/32-C5580C26	32-5580C26D/32-C5580C26D	6
Classroom	F84	32-5570C26	32-5570C26D	6
Communicating passage/Exit non-key	F111	32-5525C26	32-5525C26D	6
Institution	F87	32-5582C26	32-5582C26D	6
Dummy – single side leverset		32-5593C26	32-5593C26D	12



DUKE

- Grade 2 heavy duty cylindrical construction • Meets or exceeds requirements of BHMA/ANSI 156.2 Grade 2 • Meets cUL and UL 3-hour fire rating standards
- 5 year mechanical warranty

DESCRIPTION	ANSI FUNCTION #	SATIN CHROME C26D	SATIN CHROME C26D *clutch mechanism	CASE QTY
Entry – entrance/office leverset (inside turn button)	F109	32-7953	32-5953	10
Privacy – restroom leverset (inside turn button)	F76	32-7940	32-5940	10
Passage – hall/closet leverset	F75	32-7910	-	10
Storeroom	F86	32-7980	32-5980	10
Storeroom - 3/4" Latch (for rated paired door application per NFPA 80)	F86	32-798034SC	-	10
Classroom	F84	32-7970	32-5970	10
Communicating passage/Exit non-key	F111	32-7925	-	6
Dummy – single side leverset		32-7993	-	10



EXCALIBUR

- Grade 2 heavy duty cylindrical construction • Meets or exceeds requirements of BHMA/ANSI 156.2 Grade 2 • Meets cUL and UL 3-hour fire rating standards
- 5 year mechanical warranty

DESCRIPTION	ANSI FUNCTION #	SATIN CHROME C26D	CASE QTY
Entry – entrance/office leverset (inside turn button)	F109	32-4953	10
Privacy – restroom leverset (inside turn button)	F76	32-4940	10
Passage – hall/closet leverset	F75	32-4910	10
Storeroom	F86	32-4980	10
Classroom	F84	32-4970	10



YORK

- Grade 2 heavy duty cylindrical construction • Meets or exceeds requirements of BHMA/ANSI 156.2 Grade 2 • Meets cUL and UL 3-hour fire rating standards
- 5 year mechanical warranty

DESCRIPTION	ANSI FUNCTION #	SATIN STAINLESS STEEL C32D	CASE QTY
Entry – entrance/office ball knob (inside turn button)	F109	32-8953	20
Privacy – restroom ball knob (inside turn button)	F76	32-8940	20
Passage – hall/closet ball knob	F75	32-8910	20
Storeroom	F86	32-8980	20
Dummy – single side ball knob		32-8993	10

GRADE 2 - HEAVY DUTY



A. GRADE 2
SINGLE CYLINDER
DEADBOLT



B. GRADE 2
COMMUNICATING
DEADBOLT



C. GRADE 2 OCCUPANCY INDICATOR DEADBOLT SHOWING
RED "LOCKED" & GREEN "UNLOCKED" ICONS

- Grade 2 Heavy Duty construction • Meets or exceeds requirements of BHMA/ANSI 156.2 Grade 2
- Meets cUL and UL 3-hour fire rating standards • Schlage "C" 6-pin keyway standard (Weiser optional)
- ASA strike standard • Brass cylinder and 2 keys • Concealed screw mounting • 5 year Mechanical Warranty

BUILDER PACK	SATIN CHROME C26D	SATIN STAINLESS STEEL C32D	CASE QTY
A. Single cylinder deadbolt	32-F470	32-F450	20
B. Single sided communicating deadbolt	32-F218	-	20
C. Occupancy indicator deadbolt	32-F238	32-F238SSS	20

GRADE 2 - LIGHT DUTY



A. OXFORD TUBULAR BALL KNOB



B. WINDSOR TUBULAR LEVERSET



C. SINGLE CYLINDER DEADBOLT

- C-U/L listed for 3 hour fire rating • 6-pin solid brass Schlage 'C' keyway • Fits door 1-3/8" - 1-3/4"
- Universal handing • 5 year warranty on mechanical parts

RETAIL PACK	SATIN STAINLESS STEEL C32D	CASE QTY
A. OXFORD BALL KNOB		
Entry - entrance/office (inside turn button)	32-V1653	3
Privacy - restroom leverset (inside turn button)	32-V1640	4
Passage - hall/closet leverset	32-V1640	4
Storeroom	32-V1610	4
B. WINDSOR LEVERSET		
Entry - entrance/office (inside turn button)	32-V1853	4
Privacy - restroom leverset (inside turn button)	32-V1840	4
Passage - hall/closet leverset	32-V1810	4
Storeroom	32-V1880	4
C. DEADBOLT		
Single cylinder deadbolt (includes T-strike)	32-FV450	20

CYLINDRICAL LOCKSET PARTS & ACCESSORIES

	DESCRIPTION	PART NUMBER	SATIN CHROME C26D	SATIN STAINLESS STEEL C32D
	ASA STRIKE • 1-1/2" x 4-7/8" x 3/32" (38mm x 124mm x 2.5mm)	-	-	33-SS9109
	"T" STRIKE - 1-1/8" x 2-3/4" (28.5mm x 70mm)	-	-	33-SS9101
	RECTANGLE SQUARE CORNER DEADBOLT STRIKE • 1-1/8" x 2-3/4"	-	-	33-SS9111
	EXTENSION LINK for grade 2 – 3 hour fire rated locks & levers			
	• 35mm – for 3-3/4" (95mm) backset • 57mm – for 5" (127mm) backset	32-LE3595 32-LE57127	-	-
	KEYING KIT for "C" series locksets	32-TMKIT	-	-
	KEY BLANK			
	5 pin Schlage "C" keyway	32-SCKB2	-	-
	6 pin Schlage "C" keyway	32-SC4	-	-
	6 pin Schlage "C" keyway - Master	32-GDSCKB	-	-
	6 pin Schlage "C" keyway - Do Not Copy (DNC)	32-GDSCKB1	-	-
	5 pin Schlage "C" keyway - Tenant	32-BKKB2	-	-
6 pin Schlage "C" keyway - Tenant	32-BKSCKB	-	-	
	KEYING ACCESSORIES			
	Universal top pin	32-9300		
	Master middle pin #2	32-9322		
	Master middle pin #3	32-9323		
	Master middle pin #4	32-9324		
	Master middle pin #5	32-9325		
	Master middle pin #6	32-9326		
	Master middle pin #7	32-9327		
	Master middle pin #8	32-9328		
	Bottom pin #0	32-9310		
	Bottom pin #1	32-9311		
	Bottom pin #2	32-9312		
	Bottom pin #3	32-9313		
	Bottom pin #4	32-9314		
	Bottom pin #5	32-9315		
	Bottom pin #6	32-9316		
	Bottom pin #7	32-9317		
	Bottom pin #8	32-9318		
	Bottom pin #9	32-9319		
	Plug follower - Schlage "C"	33-9371		
	Tailpiece	32-TAILPCE		
	2-3/4" BACKSET REPLACEMENT LATCHES FOR LS SERIES LOCKS AND LEVERS • Grade 1 – C-UL rated – 3/4" projection, 1-1/8" x 2-1/4" (28mm x 57mm latch face (Required for fire rated double doors)	-	-	32-SSDBLDRATCH
	LATCHES FOR KNIGHT, YORK & CITADEL			
	2-3/4" (70mm) entry/keyed model	-	-	32-SS9060
	• 1-1/8" x 2-1/4" (28mm x 57mm) latch face, non-kick off			
	2-3/8" (60mm) entry/keyed model	-	-	32-SS9061
	• 1" x 2-1/4" (25.4mm x 57mm) latch face, non-kick off			
	2-3/4" (70mm) for privacy models	-	-	32-SS9063
	• 1-1/8" x 2-1/4" (28mm x 57mm) latch face, kick off			
	2-3/8" (60mm) for privacy models	-	-	32-SS9064
	• 1" x 2-1/4" (25.4mm x 57mm) latch face, kick off			
	2-3/4" (70mm) for passage models	-	-	32-SS9065
	• 1-1/8" x 2-1/4" (28mm x 57mm) latch face, non-kick off			
	2-3/8" (60mm) for passage models	-	-	32-SS9066
	• 1" x 2-1/4" (25.4mm x 57mm) latch face, non-kick off			
	LATCHES FOR DUKE & EXCALIBUR			
	2-3/4" (70mm) entry/keyed model	-	32-ELR794	-
	• 1-1/8" x 2-1/4" (28mm x 57mm) latch face, non-kick off			
	2-3/8" (60mm) entry/keyed model	-	32-ELR79	-
	• 1" x 2-1/4" (25.4mm x 57mm) latch face, non-kick off			
	2-3/4" (70mm) for privacy models	-	32-PLR794	-
	• 1-1/8" x 2-1/4" (28mm x 57mm) latch face, kick off			
	2-3/8" (60mm) for privacy models	-	32-PLR79	-
	• 1" x 2-1/4" (25.4mm x 57mm) latch face, kick off			
	2-3/4" (70mm) for passage models	-	32-PALR794	-
• 1-1/8" x 2-1/4" (28mm x 57mm) latch face, non-kick off				
2-3/8" (60mm) for passage models	-	32-PALR79	-	
• 1" x 2-1/4" (25.4mm x 57mm) latch face, non-kick off				
	LATCHES FOR DEADBOLTS			
	UL/cUL 3 hour 2-3/8" square mortise deadbolt (for gr 1 F series deadbolts)	-	32-DBT80	-
	UL/cUL 3 hour 2-3/4" square mortise deadbolt (for gr 1 F series deadbolts)	-	32-DBT804	-
UL/cUL 3 hour 2-in-1 square mortise deadbolt (for gr 1 F series deadbolts)	-	33-SS3HRDBLT	-	
	REPLACEMENT CYLINDERS			
	• Schlage – 6 pin for cylindrical levers, knobs & deadbolts	32-KRSCYL6	-	-
	• Schlage – 6 pin for grade 1 deadbolts	32-DRSCYL6	-	-
	• Weiser – 5 pin	32-KRWCYL5	-	-

MORTISE LOCKS

FOR COMMERCIAL APPLICATIONS

When it comes to the most heavily used door openings requiring 86 door prep, look no further than Taymor's commercial hardware mortise program. Be on spec, on budget, and in style with the right functions, lever styles, and finishes.

Cylinder (on applicable functions): (Standard 6-pin Schlage "C" keyway); 1-1/8" and 1-1/4" lengths for sectional and escutcheon configurations

3900 SERIES

Deadbolt (on applicable functions):
Solid brass with 1" (25.4 mm)
projection

Latchbolt: Stainless steel
latchbolt with 2 anti-friction tongues;
3/4" (18 mm) projection; field reversible





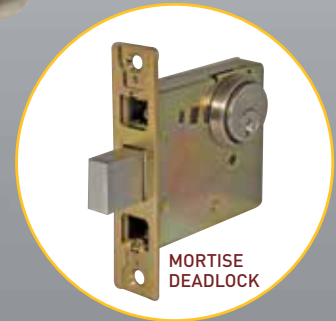
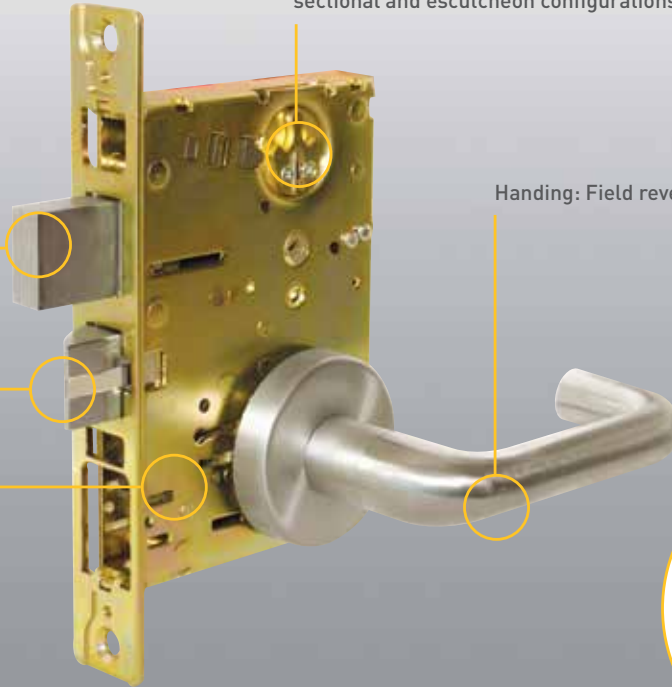

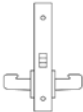
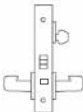

Mortise case: 12 gauge fully
wrapped heavy duty steel

Handing: Field reversible handing

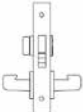
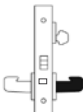



MORTISE DEADLOCK





COMMERCIAL MORTISE FUNCTIONS

MORTISE, NON-KEYED	MORTISE, KEYED	MORTISE, KEYED	MORTISE, DEADLOCK
 <p>Passage hall/ closet</p> <p>ANSI F01</p>	 <p>Classroom</p> <p>ANSI F05</p>	 <p>Dormitory</p> <p>ANSI F13</p>	 <p>Classroom deadlock</p> <p>ANSI F29</p>
 <p>Privacy/ bedroom/ bath</p> <p>ANSI F19</p>	 <p>Storeroom/ closet</p> <p>ANSI F07</p>	 <p>Storeroom with Deadbolt (with & without toggle)</p> <p>-</p>	 <p>Single cylinder</p> <p>ANSI F17</p>
MORTISE, KEYED			
 <p>Office/ entry</p> <p>ANSI F04</p>	 <p>Exit</p> <p>ANSI F12</p>	 <p>Apartment/ corridor</p> <p>ANSI F20</p>	 <p>Double cylinder</p> <p>ANSI F16</p>

COMMERCIAL MORTISE STYLES & FINISHES - SECTIONAL ROSE TRIMS

ENVOY MORTISE TRIM	DUKE MORTISE TRIM	CITADEL MORTISE TRIM (SPECIAL ORDER)	
			C26D SATIN CHROME ANSI 626
			AVAILABLE FINISH

MORTISE LOCK ACCESSORIES

	MORTISE DEADLOCK FUNCTION	ANSI#	SATIN NICKEL C15	POLISHED CHROME C26	SATIN CHROME C26D	CASE QTY
	Classroom mortise deadlock-KD	F29	39-M29C15	39-M29C26	39-M29C26D	20
	Single cylinder mortise deadlock	F17	39-M17C15	39-M17C26	39-M17C26D	20
	Double cylinder mortise deadlock	F16	39-M16C15	39-M16C26	39-M16C26D	20
	MORTISE CYLINDERS DESCRIPTION Schlage 6 pin 'C' keyway, 1-1/8"D (used with sectional rose trim)		39-MSCYL118C15	39-MSCYL118C26	39-MSCYL118C26D	100
	Schlage 6 pin 'C' keyway, 1-1/4"D (used with escutcheon trim)		39-MSCYL114C15	39-MSCYL114C26	39-MSCYL114C26D	100
	CLOVERLEAF CAM DESCRIPTION Cloverleaf cam for mortise cylinders			ITEM NO. 39-CLCAM		CASE QTY 10
	STRIKES & FACEPLATES FUNCTION					
	Passage		39-PLTSTRK10C15	39-PLTSTRK10C26	39-PLTSTRK10C26D	60
	Classroom or storeroom/closet		39-PLTSTRK70C15	39-PLTSTRK70C26	39-PLTSTRK70C26D	60
	Dormitory/exit or privacy/bath		39-PLTSTRK56C15	39-PLTSTRK56C26	39-PLTSTRK56C26D	60
	Hotel/motel		39-PLTSTRK86C15	39-PLTSTRK86C26	39-PLTSTRK86C26D	60
	Apartment/corridor or office/entry		39-PLTSTRK53C15	39-PLTSTRK53C26	39-PLTSTRK53C26D	60
	STRIKES & FACEPLATES FOR DEADLOCK DESCRIPTION Mortise deadlock face plate & strike		39-PLTSTRKDBC15	39-PLTSTRKDBC26	39-PLTSTRKDBC26D	60

HOW TO PLACE YOUR ORDER Use our easy to understand item numbering system to place your order. Our customer service team would also be happy to help you.



ITEM NUMBER (EXAMPLE)
39-S6077C26D



FINISH:	SATIN NICKEL	SATIN CHROME	POLISHED CHROME	STYLE:	DUKE	ENVOY	CITADEL
ANSI/BHMA	619	626	625		-	-	-
	C15	C26D	C26		77	88	55

MOUNTING:	ESCUTCHEON	SECTIONAL ROSE TRIM	FUNCTION:	PASSAGE	PRIVACY	OFFICE/ENTRY	CLASSROOM	STOREROOM / CLOSET	EXIT	DORMITORY	STOREROOM w/DEADBOLT	STOREROOM w/ DEADBOLT + TOGGLE	APARTMENT / CORRIDOR
	-	-	ANSI #	F01	F19	F04	F05	F07	F12	F13	-	-	F20
	E	S	TAYMOR ITEM #	10	40	60	70	80	57	56	90	92	50

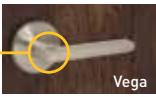
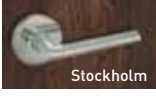
RESIDENTIAL MORTISE STYLES



 Vega
 Stockholm
 Britannia
 Bergen

 C15
SATIN NICKEL
ANSI 619
 C26
POLISHED CHROME
ANSI 625
 C26D
SATIN CHROME
ANSI 626

Taymor's residential mortise locks are available in our four most popular lever styles and in three sleek finishes designed to deliver consistent style for the whole home.

Contact your sales representative for further information.

DOOR CLOSERS

From the heaviest duty commercial fire doors down to light duty residential doors, count on Taymor Door Closer products for code compliance, longevity, and construction project value.

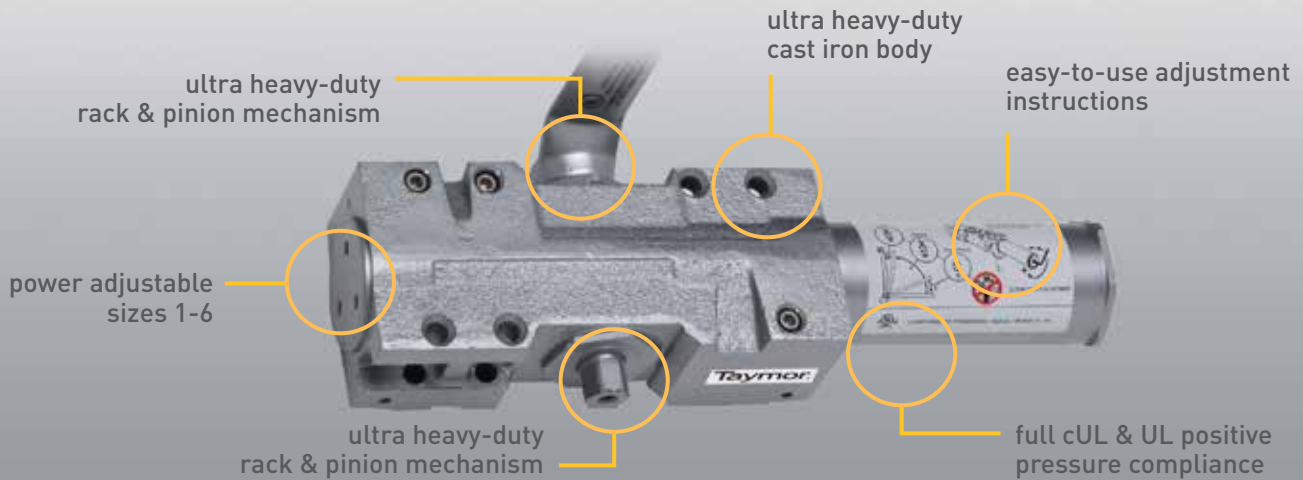

NEW!

4000 SERIES DOOR CLOSER

- UL, c-UL listed and UL10C compliant for positive pressure
- Meets or exceeds BHMA/ANSI A156.4-Grade 1
- Power adjustable 1-6
- Standard barrier free operation (complies with ADA)
- Standard backcheck, standard sweep and latching speed
- Non-handed installation
- Cast iron body
- High grade quality plastic cover
- Standard tri-packed for regular arm, top jamb and parallel arm application
- Rack and pinion mechanism
- 20 year guarantee



MEETS ADA STANDARDS

SIZE	MAXIMUM RECOMMENDED DOOR SIZE & WEIGHT	ALUMINUM	CASE QTY
1-6	48" x 96" - (121cm x 243cm) 266 lbs / (121 kg)	13-4000AL	6

4000 SERIES DOOR CLOSERS PARTS & ACCESSORIES

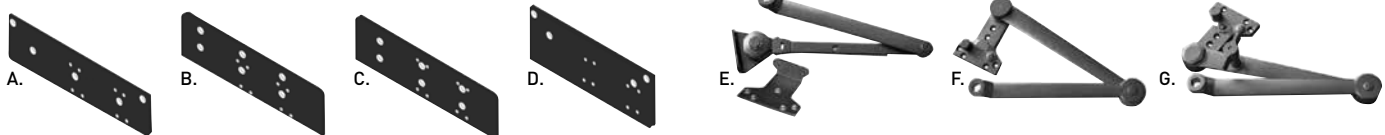

	DESCRIPTION	ALUMINUM	CASE QTY
A.	Regular or top jamb narrow drop plate - 2" tall (51mm)	13-A4000DPRAL	10
B.	Parallel arm drop plate - 3-9/16" tall (90 mm)	13-A4000DPLCAL	10
C.	Parallel arm bracket for friction hold open arm	13-A4000DPTJAL	10
D.	Parallel arm bracket	13-A4000PAMAL	10
E.	Standard assembly arm	13-A4000FHOAL	10
F.	Friction type - hold open arm*	13-A4000CSAL	10
G.	Cush stop arm	13-A4000SHOAL	10

* Not for use on fire-rated doors

1900 SERIES DOOR CLOSER

- UL and c-UL listed compliant UL10C for positive pressure • Meets or exceeds ANSI A156.4 – Grade 1 • Power adjustable 1-6 • Standard barrier free operation (complies with ADA)
- Standard backcheck, standard sweep and latching speed • Standard delayed action on 13-1900BFDAAL model • Non-handed installation • Cast aluminum body • High grade quality plastic cover • Universal mounting _ regular & parallel bracket included • Rack and pinion mechanism • 10 year guarantee



SIZE	MAXIMUM RECOMMENDED DOOR SIZE & WEIGHT	ALUMINUM	CASE QTY
1-6	Adjustable power 1 through 6 with standard backcheck and barrier free 48" x 96" – (121cm x 243cm) 266 lbs / (121 kg)	13-1900AL	6
1-6	Adjustable power 1 through 6 with standard backcheck, barrier free and delayed action 48" x 96" – (121cm x 243cm) 266 lbs / (121 kg)	13-1900BFDAAL	6

1900 SERIES DOOR CLOSERS PARTS & ACCESSORIES

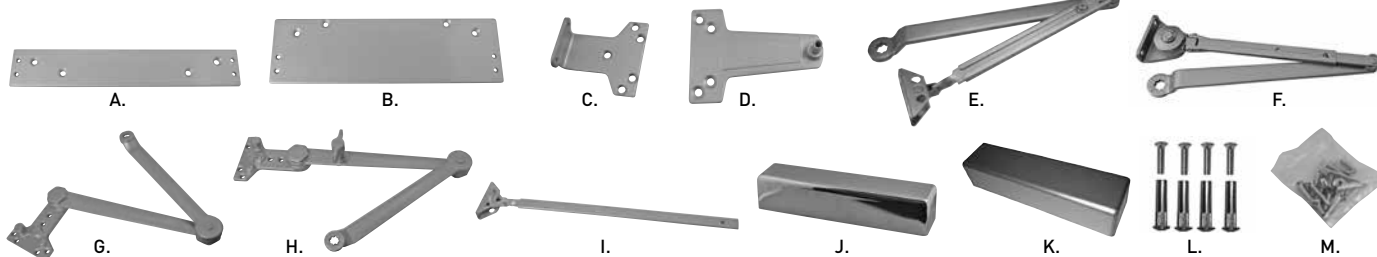

DESCRIPTION	ALUMINUM	CASE QTY
A. Regular or top jamb narrow drop plate – 2" tall (51mm)	13-A1900DP51AL	10
B. Parallel arm drop plate – 3-9/16" tall (90 mm)	13-A1900DP90AL	10
C. Parallel arm bracket for friction hold open arm	13-A1900PAFHOAL	10
D. Parallel arm bracket	13-A1900PABAL	30
E. Standard assembly arm	13-A1900SMAAL	10
F. Friction type – hold open arm*	13-A1900FHOAL	10
G. Cush stop arm	13-A1900CSAAL	10
H. Cush stop hold open arm*	13-A1900CSHOAAL	10
I. Extended long rod and shoe	13-A1900ELRSAL	50
J. Metal cover	13-A1900MC26	10
K. Plastic cover	13-A1900FPCAL	10
L. Thru bolts	13-A1900SNBAL	10
M. Screw pack	13-A1900SPAL	10

* Not for use on fire-rated doors

600/620 SERIES DOOR CLOSERS

- Meets or exceeds the requirements of BHMA/ANSI 156.4 Grade 3 • UL and c-UL listed compliant UL10C for positive pressure • Spring size closer 2, 3 and 4 • High strength aluminum alloy body • Non-handed
- Two independent adjustable valves control sweeping and latching speed • Universal mounting (regular and parallel brackets included) • Supplied with both machine and wood screws • 5 year warranty



SIZE	MAXIMUM RECOMMENDED DOOR SIZE & WEIGHT	POLISHED BRASS C3	POLISHED CHROME C26	ALUMINUM	CASE QTY
2	36" x 84" – (90cm x 210cm) 55-100 lbs / (25-45 kg)	14-602BR	–	14-602AL	10
3	38" x 84" – (95cm x 210cm) 88-144 lbs / (40-64 kg)	–	14-1623C26	14-603AL	10
4	42" x 96" – (105cm x 240cm) 132-187 lbs / (60-84 kg)	–	–	14-604AL	10

SPRING POWER SIZE 3 CLOSER IN A SIZE 2 BODY

SIZE	MAXIMUM RECOMMENDED DOOR SIZE & WEIGHT	POLISHED BRASS C3	POLISHED CHROME C26	ALUMINUM	CASE QTY
3	38" x 84" – (95cm x 210cm) 88-144 lbs / (40-64 kg)	–	–	14-623AL	10
	Plastic cover	14-1600BR	–	14-C1600AL	10

600 SERIES DOOR CLOSERS PARTS & ACCESSORIES



DESCRIPTION	ALUMINUM	CASE QTY
Parallel arm bracket	14-PAB603AL	10

550 SERIES DOOR CLOSER

- Meets or exceeds the requirements of BHMA/ANSI 156.4 Grade 2 • UL and c-UL listed compliant UL10C for positive pressure • Spring size closer 2, 3 and 4 • High strength aluminum alloy body • Non-handed • Two independent adjustable valves control sweeping and latching speed
- Universal mounting (regular and parallel brackets included)
- Supplied with both machine and wood screws
- 5 Year warranty



SIZE	MAXIMUM RECOMMENDED DOOR SIZE & WEIGHT	ALUMINUM	CASE QTY
2	36" x 84" - (90cm x 210cm) 55-100 lbs / (25-45 kg)	13-552APAL	10
3	38" x 84" - (95cm x 210cm) 88-144 lbs / (40-64 kg)	13-553APAL	10
4	42" x 96" - (105cm x 240cm) 132-187 lbs / (60-84 kg)	13-554APAL	10

500 SERIES DOOR CLOSER

- Meets or exceeds the requirements of BHMA/ANSI 156.4 Grade 2 • UL listed & c-UL listed • Spring size closer 1, 2, 3 and 4 • High strength aluminum alloy body • Non-handed
- Two independent adjustable valves control sweeping and latching speed • Universal mounting (regular arm and parallel bracket included) • Supplied with both machine and wood screws • 5 year warranty



SIZE	MAXIMUM RECOMMENDED DOOR SIZE & WEIGHT	ALUMINUM	CASE QTY
1	33" x 72" - (80cm x 180cm) 45-90 lbs / (20-40 kg)	11-501APAL	10
2	36" x 84" - (90cm x 210cm) 55-100 lbs / (25-45 kg)	11-502APAL	10
3	38" x 84" - (95cm x 210cm) 88-144 lbs / (40-64 kg)	11-503APAL	10
4	42" x 96" - (105cm x 240cm) 132-187 lbs / (60-84 kg)	11-504APAL	10

690 SERIES DOOR CLOSER

- Meets or exceeds the requirements of BHMA/ANSI 156.4 Grade 3 • UL and c-UL listed compliant UL10C for positive pressure • Spring size closer 3, 4 and 5 • High strength aluminum alloy body • Non-handed • Three independent adjustable valves control backcheck, sweeping and latching speed
- Universal mounting (regular and parallel brackets included) • Supplied with both machine and wood screws
- 5 Year warranty



SIZE	MAXIMUM RECOMMENDED DOOR SIZE & WEIGHT	ALUMINUM	CASE QTY
2	38" x 84" - (95cm x 210cm) 88-144 lbs / (40-64 kg)	14-693AL	6
3	42" x 96" - (105cm x 240cm) 132-144 lbs / (40-64 kg)	14-694AL	6
4	42" x 96" - (105cm x 240cm) 132-187 lbs / (60-84 kg)	14-695AL	6

EXIT HARDWARE

Spec. Style. Value. Taymor's new ultra heavy-duty Grade 1 9700 series and standard duty 8500 series exit devices now share a common family of Grade 1 trims. Choose Taymor for exit openings that meet code requirements affordably and with style.

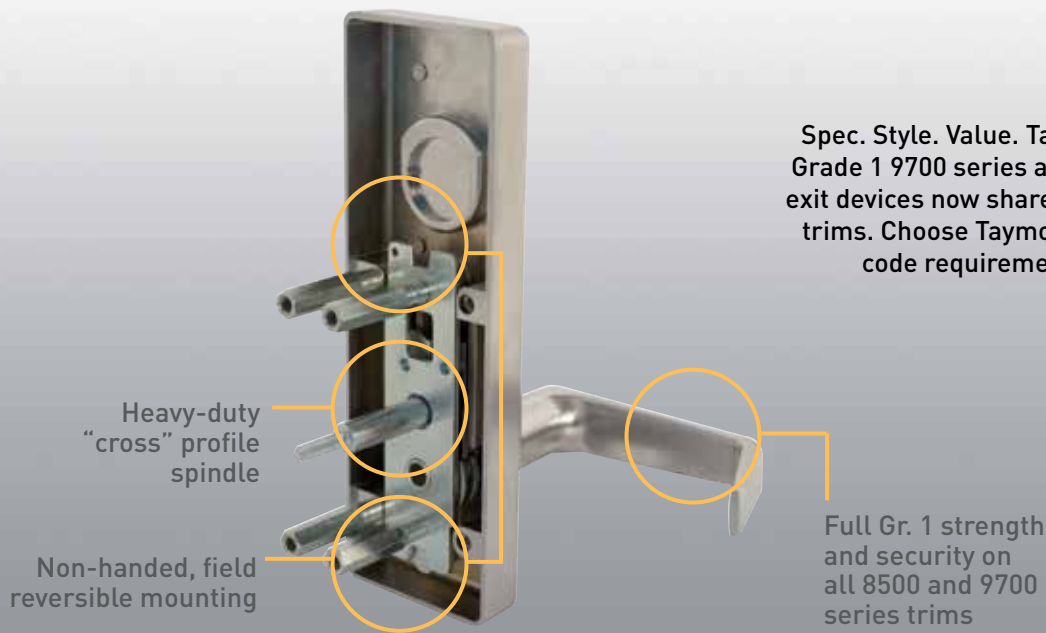

PUSH PADS/BARS

NEW!

9700 SERIES PUSH PAD EXIT DEVICE

- **Specification:** Meets or exceeds BHMA/ANSI Grade 1
- **Type:** 9700 Series Safety Rated, F9700 Series Fire Rated
- **Certification:** c-UL listed, UL 10C 1.5 hours for Fire Rated
- **Models:** Rim & Surface Vertical Rod
- **Finish:** Stainless steel (C32D)
- **Installation:** 28" to 48" wood or hollow metal doors, retrofit 161 Door Prep
- **Door sizes:** Mimimum = 28" x 84"; maximum = 48" x 96"
Maximum cut-down of bar width = 8" (28" total width)
- **Trims:** Please refer to the accessories page
- **Warranty:** 5 years



SAFETY RATED

	STAINLESS STEEL C32D	CASE QTY
9700 Series safety rated rim exit device for 28" - 36" door [71 cm - 91 cm]	17-9736SSS	2
9700 Series safety rated surface mount vertical rod exit device for 28" - 36" door [71 cm - 91 cm] x 84" [213 cm]	17-9736VSSS	2
9700 Series safety rated rim exit device for 37" - 48" door [94 cm - 122 cm]	17-9748SSS	2
9700 Series safety rated surface mount vertical rod exit device for 37" - 48" door [94 cm - 122 cm] x 96" [244 cm]	17-9748VSSS	2

FIRE RATED

9700 Series fire rated rim exit device for 28" - 36" door [71 cm - 91 cm]	17-F9736SSS	2
9700 Series fire rated surface mount vertical rod exit device for 28" - 36" door [71 cm - 91 cm] x 84" [213 cm]	17-F9736VSSS	2
9700 Series fire rated rim exit device for 37" - 48" door [94 cm - 122 cm]	17-F9748SSS	2
9700 Series fire rated surface mount vertical rod exit device for 37" - 48" door [94 cm - 122 cm] x 96" [244 cm]	17-F9748VSSS	2



8500 SERIES PUSH PAD EXIT DEVICE

- **Type:** 8500 Series Safety Rated, F8500 Series Fire Rated
- **Certification:** c-UL listed, UL 10C 1.5 hours for Fire Rated
- **Models:** Rim & Surface Vertical Rod
- **Finishes:** Aluminum (C28) and Stainless steel (C32D)
- **Installation:** 28" to 36" wood or hollow metal doors, retrofit 161 Door Prep
- **Door sizes:** Mimimum = 28" x 84"; maxiumum = 36" x 96"
Maximum cut-down of bar width = 8" (28" total width).
- **Trims:** Uses same trims as 9700 series grade 1 exit device
Please refer to the accessories page
- **Warranty:** 3 years

DESCRIPTION	ALUMINUM C28	STAINLESS STEEL C32D	CASE QTY
8500 Series rim exit device for 28" – 36" door (71cm – 91cm)	17-8536AL	17-8536SS	6
8500 Series surface vertical rod exit device for 28" – 36" door (71cm – 91cm) x 84" (213 cm)	17-8536VAL	17-8536VSS	4
8500 Series fire rated rim exit device for 28" – 36" door (71cm – 91cm)	17-F8536AL	17-F8536SS	6
8500 Series fire rated surface vertical rod exit device for 28" – 36" door (71cm – 91cm) x 84" (213 cm)	17-F8536VAL	17-F8536VSS	4

900 SERIES PUSH BAR EXIT DEVICE – ADA COMPLIANT

- **Material:** heavy duty steel pressed
- **Certification:** c-UL and UL listed for safety
- **Finish:** Aluminum (C28)
- **Door thickness:** Maximum of 2" (51mm) thick
- **Dogging function:** Yes
- **Trims:** Entry function with rim cylinder, rim cylinder – Diameter 1-1/8" (29mm) is not included and must be ordered separately
- **Warranty:** 3 years



EXIT ONLY – BUILDER PACK

WHERE NO BUILDING ACCESS IS REQUIRED ON EXTERIOR DOORS
– COMPLETE WITH 38" (97CM) STANDARD CROSS BAR

	PART NO.	ALUMINUM C28	CASE QTY
Right hand reverse opening	-	17-900ALRR	6
Left hand reverse opening	-	17-900ALLR	6

EXTERIOR ACCESS BY KEY & THUMB LATCH – BUILDER PACK

KEY UNLOCKS THUMB LATCH
– COMPLETE WITH 38" (97CM) STANDARD CROSS BAR

Right hand reverse opening	-	17-950ALRR	6
Left hand reverse opening	-	17-950ALLR	6

ACCESSORIES

38" (97cm) steel bar	17-R938AL	-	6
48" (122cm) steel bar	17-R948AL	-	6

TRIMS

NEW!

9700/8500 SERIES ESCUTCHEON LEVER TRIM

- Meets or exceeds BHMA/ANSI grade 1 ultra-heavy duty actuating mechanism
- Compatible with 8500 & 9700 series push pad exit device
- Rim cylinder with 6 pin Schlage 'C' keyway for storeroom function
- Mortise cylinder (1-1/8" depth) 6 pin Schlage "C" keyway for entry function



DESCRIPTION

Entry function - Schlage 'C' keyway
 Storeroom function
 Passage function

SATIN CHROME C26D
 17-ESCU70SC
 17-ESCU80SC
 17-ESCU55SC

CASE QTY
 8
 8
 8

NEW DESIGN!

9700/8500 SERIES LEVER TRIM

- Meets or exceeds BHMA/ANSI grade 1 ultra-heavy duty actuating mechanism
- Compatible with 8500 & 9700 series push pad exit device
- 6 pin Schlage 'C' keyway for entry and storeroom functions



DESCRIPTION

Entry function - Schlage 'C' keyway
 Storeroom function
 Passage function

SATIN CHROME C26D
 17-LEVAL
 17-SRLEVAL
 17-PALEVSC

CASE QTY
 6
 6
 6

NEW DESIGN!

9700/8500 SERIES OUTSIDE THUMBPIECE TRIMS

- Meets or exceeds BHMA/ANSI grade 1 ultra-heavy duty actuating mechanism
- **Compatibility:** 8500 series push pad exit device
- **Function:** Non-handed outside thumbpiece trims
- **Material:** Heavy duty cast zinc alloy for handle and plate
- **Finishes:** aluminum (C28)
- **Mounting peg:** 5-1/2" C/C distance
- **Escutcheon plate size:** 3" x 12-5/16" x 3/32" (76mm x 312.5mm x 2.5mm)
- **Projection:** 25/32" (45mm) maximum
- **Rim Cylinder:** 6 pin schlage "C" keyway for storeroom function
- **Mortise cylinder:** (1-1/8" depth) 6 pin Schlage "C" keyway for entry function
- **Trims/functions:** entry, storeroom, passage and dummy

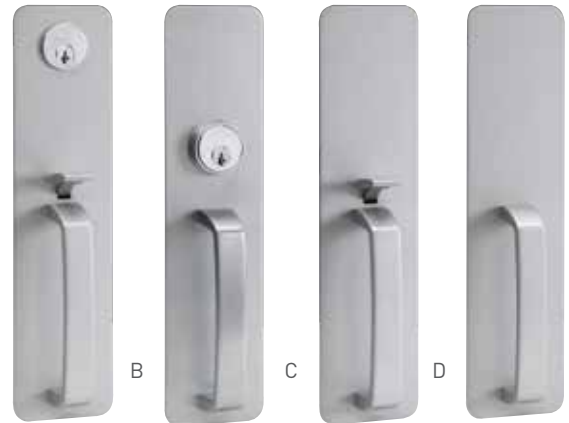

DESCRIPTION

A. Entry function
 B. Storeroom function
 C. Passage function
 D. Dummy function

ALUMINUM C28
 17-ENTPAL
 17-STTPAL
 17-PSTPAL
 17-DUPAL

CASE QTY
 10
 10
 10
 10

9700/8500 SERIES BALL KNOB TRIM

- Meets or exceeds BHMA/ANSI grade 1 ultra-heavy duty actuating mechanism
- Compatible with 8500 & 9700 series push pad exit device
- 6 pin Schlage 'C' keyway for entry and storeroom functions



DESCRIPTION

Entry function - Schlage 'C' keyway
 Storeroom function

SATIN CHROME C26D
 17-ENBKAL
 17-SRBKAL

CASE QTY
 6
 6

EXIT HARDWARE ACCESSORIES

DESCRIPTION	ALUMINUM C28	SATIN CHROME C26D	SATIN STAINLESS STEEL C32D	CASE QTY
 Vertical surface rod replacement kit - 7' rod	-	-	17-97VRTR0D7SSS	40
 Vertical surface rod replacement kit - 8' rod	-	-	17-97VRTR0D8SSS	40
 Exit only plate, where no building access required on exterior doors 3-1/2" x 5" [89mm x 127mm]	17-EOPAL	-	-	6
 Exit only plate with cylinder hole and rim cylinder socket for exterior access by key only, cylinder not included Trim mounting plate included [17-PPMTMP]	17-ECPAL	-	-	6
 Pull profile Exterior access only when dogging feature is in function 3-1/2" x 6-1/4" [89mm x 159mm]	17-PP06AL	-	-	6
 Pull profile with cylinder hole and rim cylinder socket Latch bolt is retracted by key from outside Cylinder not included, trim mounting plate included [17-PPMTMP] 3-1/2" x 6-1/4" [89mm x 159mm]	17-PP05AL	-	-	6
 Lip pull with cylinder hole Latch bolt is retracted by key from outside Cylinder not included, trim mounting plate included [17-ppmtmp] 1-3/4" x 3" [45mm x 75mm]	17-LP01AL	-	-	6
 Trim mounting plate	17-PPMTMP	-	-	6
 Overlap strike for double door applications	17-PS09AL	-	-	6
 Rim cylinder • Schlage 'C' keyway – 6 pin • Weiser keyway – 6 pin	17-SS800AAL 17-SW800AAL	- -	- -	6 6
 Mortise cylinder (1-1/8") • Schlage 'C' keyway – 6 pin • Weiser keyway – 6 pin	17-DBS61 17-DB61	- -	- -	10 10
 Standard cam for mortise cylinder (for use with 8500 series)	17-STDCAM	-	-	10
 Adams rite cam for mortise cylinder	17-ARCAM	-	-	10
 Cloverleaf cam for mortise cylinder (for use with 3900 series mortice locks only)	39-CLCAM	-	-	10



4100 SERIES COMMERCIAL 4-1/2" x 4" TEMPLATE BUTT HINGES • Conforms to government and commercial standards and are made exact in size, gauge of metal, and screw hole location • Meets or exceeds BHMA/ANSI – A156.1 Grade 2 requirements • Ball bearing type hinges must be used on doors in conjunction with door closers and on all fire-rated openings • Full mortise type • 3 pieces (1-1/2 pairs) per set • 1 set packaged in a box • Full set machine and wood screws included • Available in plain bearing, ball bearing and NRP (non-removable pin)

4-1/2" x 4" TEMPLATE SQUARE	POLISHED BRASS C3	SATIN NICKEL C15	POLISHED CHROME C26	SATIN CHROME C26D	SATIN STAINLESS STEEL C32D	GREY PRIMED CP	CASE QTY
A. Plain bearing butt hinges	25-4169BP	25-4169N	–	25-4169DC	–	25-4169PC	16
B. Non-removable pin plain bearing butt hinges	25-4170BP	25-4170N	–	25-4170DC	–	25-4170PC	16
C. Ball bearing butt hinges	25-4172BP	25-4172N	25-4172CH	25-4172DC	–	25-4172PC	16
D. Non-removable pin ball bearing butt hinges	25-4173BP	25-4173N	–	25-4173DC	25-4173SS	25-4173PC	16
E. Heavy duty non-removable pin ball bearing butt hinges	–	–	–	–	25-4174SS	–	16

PARTS FOR COMMERCIAL HINGES

DESCRIPTION	BRASS C3	NICKEL C15	OTHER	CASE QTY
Machine screws for 25-4172	–	25-MS4100N	–	500
Template butt screws	25-WMSB3100	25-WMSN3100	–	150
Replacement pin for 3300 spring hinges	–	–	25-43PIN	100

COMMERCIAL ARCHITECTURAL HARDWARE

PUSH PLATES & DOOR PULLS

A. DOOR PULL WITH PUSH PLATE

- 0.046" (1.17mm) gauge aluminum
- Includes self tapping screws suitable for metal or wood doors



B. DOOR PULL HANDLE

- Aluminum construction
- Pull handle includes thru-bolts & grommets



C. PUSH PLATE

- 0.046" (1.17mm) gauge aluminum • 0.038" (0.97mm) solid brass • Includes self tapping screws suitable for metal or wood doors



DESCRIPTION	PKG	SATIN ALUMINUM	POLISHED BRASS C3	CASE QTY
A. 178 mm (7") pull with 89 mm x 381 mm (3.5" x 15") push plate	C	25-D400715	–	10
A. 229 mm (9") pull with 102 mm x 406 mm (4" x 16") push plate	C	25-D400916	–	10
B. 178 mm (7")	BX	25-4007	–	20
B. 229 mm (9")	BX	25-4009	–	20
C. 89 mm x 381 mm (3.5" x 15")	PB	25-4115	–	20
C. 102 mm x 406 mm (4" x 16")	PB	25-4116	–	20
C. 102 mm x 406 mm (4" x 16")	C	25-D416	25-D7316PB	10

PKG: C = CARDED, BX = INDIVIDUALLY BOXED WITH UPC, PB = POLY BAGGED WITH UPC

DOOR STOPS



A. FLOOR STOP



B. WALL STOP CONVEX



C. WALL STOP CONCAVE



D. ARCHITECTURAL RISER

A-C. FLOOR & WALL STOPS • Complete with screws & expansion shields • Rubber bumpers • Zinc die-cast construction

DESCRIPTION	SATIN NICKEL C15	SATIN CHROME C26D	CASE QTY
A. Floor stops – 1" low profile	25-4609DN	25-4609DC	10
A. Floor stops – 1-3/8" High profile	25-4610DN	25-4610DC	10
B. Wall stops – Convex	25-4611DN	25-4611DC	10
C. Wall stops – Concave	25-4612DN	25-4612DC	10

PKG: BIN BOX, POLY BAGGED WITH UPC

D. ARCHITECTURAL RISER • 1/4" Riser for 25-4609 & 25-4610 • Complete with screws & expansion shields • Zinc die-cast construction

PKG	ALUMINUM	CASE QTY
BIN BOX, POLY BAGGED WITH UPC	25-4608AL	25

HOSPITALITY & COMMERCIAL BATHWARE

Taymor is one of North America's leading suppliers of bath hardware programs to the hospitality industry. In addition to our instock assortment, we are able to work with project designers to create custom designs to meet your unique project requirements. Combine this with our exceptional customer service and our value is hard to beat.

TOWEL SHELVES

GUEST TOWEL SHELVES

- Exposed surface mount application • Includes #8 x 1-1/4" (32mm) mounting screws and 2 welded mounting plates constructed of triple chrome plated steel

Mounting frames

- 1/4" (6mm) outer diameter
- Construction: chrome plated steel wire shelves
- 3/16" (5mm) outer diameter
- Construction: triple chrome plated wire



A. 2 GUEST TOWEL HOLDER



B. 4 GUEST TOWEL HOLDER

DESCRIPTION	PKG	POLISHED CHROME C26	CASE QTY
A. 2 guest towel holder	RETAIL PACK	01-1062	4
B. 4 guest towel holder	RETAIL PACK	01-1064	4

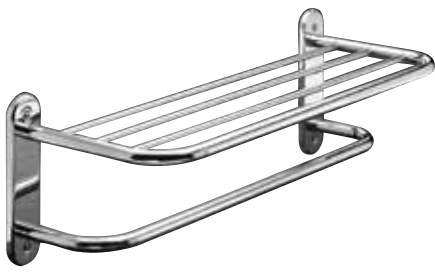

A. TOWEL SHELF WITH BAR

- Semi-concealed surface mount application
- Includes 4 plastic anchors and 4 steel Phillips head screws – #8 x 2" (50.80mm)
- 3/4" (19.05mm) tubing



B. TOWEL SHELF WITH DOUBLE BAR

- Semi-concealed surface mount application
- Includes 4 plastic anchors and 4 steel Phillips head screws – #8 x 2" (50.80mm)
- 3/4" (19.05mm) tubing



C. 24" EUROPEAN TOWEL SHELF

- Comes fully assembled
- Concealed mount back plates
- Mounting hardware included
- Overall dimensions: 25-3/8" W x 4-5/16" H x 9-5/8" D (65cm W x 11.6cm H x 24.5cm D)

DESCRIPTION	PKG	SATIN NICKEL	POLISHED CHROME C26	CASE QTY
A. 18" towel shelf with bar	CONTRACTOR PACK	-	01-1043	5
A. 24" towel shelf with bar	CONTRACTOR PACK	-	01-1044	5
B. 24" towel shelf with double bar	CONTRACTOR PACK	-	01-1045	5
C. 24" European towel shelf	RETAIL BOX	01-1049SN	01-1049	4

PAPER HOLDERS & MORE

RECESSED TISSUE DISPENSER

- Includes #8 x 1-1/4" (32mm) screws • Wall opening: 11-3/8" (289mm) x 5-1/8" (130mm) • Recessed Container construction: galvanized sheet metal 0.031" (0.8mm) – 22 gauge wall thickness
- Face Plate construction: cold rolled polished chrome plated steel 0.031" (0.8mm) – 22 gauge wall thickness



DESCRIPTION	PKG	POLISHED CHROME C26	CASE QTY
Recessed tissue dispenser	CONTRACTOR PACK	01-1010	6

TWIN RECESSED PAPER HOLDER

- Recessed container housing with countersunk mounting holes
- Includes #8 x 1-1/4" (32mm) mounting screws for screw-in application • Wall opening: 11-3/16 (284mm) x 5-1/8 (130mm)
- Posts securely riveted to housing • Roller construction: white plastic with spring tension

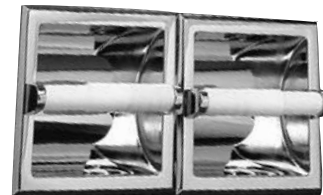

DESCRIPTION	PKG	POLISHED CHROME C26	CASE QTY
Twin recessed paper holder	CONTRACTOR PACK	01-TW101S	10

RECESSED PAPER HOLDERS

- Cement-in and Screw-in options available • Posts securely riveted to housing • Countersunk mounting holes • Wall opening: 5-1/8" (130mm) x 5-1/8" (130mm) • Includes #10 x 2" (50.80mm) mounting screws
- Roller construction: white plastic with spring tension

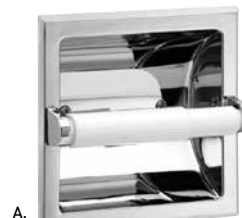

A. MATCHES SUNGLOW COLLECTION (PG. 25)



B. MATCHES SUNDIAL COLLECTION (PG. 25)

PKG	SATIN NICKEL C15	POLISHED CHROME C26	CASE QTY	DESCRIPTION	PKG	POLISHED CHROME C26	CASE QTY
A. CONTRACTOR PACK	-	01-101S	50	B. Cement-in	CONTRACTOR PACK	01-1863C	50
				B. Screw-in	CONTRACTOR PACK	01-1863S	50

RECESSED EXTRA ROLL PAPER HOLDER

- Housing with countersunk mounting holes
- Includes #8 x 1-1/4" (32mm) mounting screws for screw-in application • Wall opening: 5-5/16 (135mm) x 5-5/16 (135mm) • 4" (102 mm) deep
- Recessed container construction: galvanized sheet metal • Roller construction: white plastic with spring tension



SINGLE FIXED PAPER HOLDER

- Exposed surface mount application
- Includes #10 x 1" (25mm) mounting screws for screw-in application • Drilled holes 3-1/4" (83mm) center to center • Locking device prevents removal of roll until paper is used
- Spring tension arms control paper flow



PKG	POLISHED CHROME C26	CASE QTY
CONTRACTOR PACK	01-1070	10

PKG	POLISHED CHROME C26	CASE QTY
CONTRACTOR PACK	01-F1015	25

DOUBLE FIXED PAPER HOLDER

- Exposed surface mount application • Includes #10 x 1" (25mm) mounting screws for screw-in application • Drilled holes 8-1/8" (206mm) center to center • Locking device prevents removal of roll until paper is used • Spring tension arms control paper flow



DESCRIPTION	PKG	POLISHED CHROME C26	CASE QTY
Double fixed paper holder	CONTRACTOR PACK	01-F1030	25

TWIN SURFACE MOUNT PAPER HOLDER

- Matches Sundial collection (pg 25) • Exposed surface mount application • Includes #10 x 1" (25mm) mounting screws for screw-in application • Drilled holes 5-1/2" (140mm) center to center
- Grey plastic roller



RETRACTABLE CLOTHES LINE

- Concealed surface mount application
- Includes mounting plate and #8 x 1-1/4" (32mm) screws • Cover construction: polished stainless steel • Cord: 7' (213cm) nylon cord



PKG	POLISHED CHROME C26	CASE QTY
CONTRACTOR PACK	01-TW301S	20

PKG	POLISHED CHROME C26	CASE QTY
RETAIL PACK	02-D1099	60

RECESSED SOAP HOLDER WITH UTILITY BAR

- Matches Sundial collection (pg 25)
- Recessed container housing with countersunk mounting holes
- Includes #10 x 2" (51mm) mounting screws for screw-in application
- Wall opening: 5-1/8" (130mm) x 5-1/8" (130mm) • Non-removable soap dish



RECESSED SOAP HOLDER WITH UTILITY BAR

- Matches Sundial collection (pg 25)
- Countersunk mounting holes • Includes #10 x 2" (50.80mm) mounting screws
- Wall opening: 5-1/8" (130mm) x 5-1/8" (130mm) • Utility Bar construction: diecast stainless steel #4 in general purpose finish • Soap Holder: includes a removable plastic soap tray with mounting slots on each side



DESCRIPTION	PKG	POLISHED CHROME C26	CASE QTY
Cement-in	CONTRACTOR PACK	01-1861C	50
Screw-in	CONTRACTOR PACK	01-1861S	50

DESCRIPTION	PKG	POLISHED CHROME C26	CASE QTY
Cement-in	CONTRACTOR PACK	01-102S	50
Screw-in	RETAIL PACK	02-D102S	5

RECESSED SOAP HOLDER WITH UTILITY BAR

- Posts securely riveted to housing • Countersunk mounting holes • Includes #10 x 2" (50.80mm) mounting screws • Wall opening: 5-1/8" (130mm) x 5-1/8" (130mm)
- Utility Bar construction: chrome plated zinc alloy
- Non-removable soap dish



INSTALLATION CLAMP

- For all screw mount recessed fixtures
- Construction: stamped steel
- 1-3/8" x 7-3/8" (35mm x 187mm)

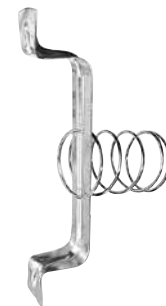

DESCRIPTION	PKG	POLISHED CHROME C26	CASE QTY
Cement-in	CONTRACTOR PACK	01-1862C	50
Screw-in	CONTRACTOR PACK	01-1862S	50

PKG	STAMPED STEEL	CASE QTY
RETAIL PACK	02-D1003	10

CORNER BASKETS

CORNER BASKETS

- Exposed surface mount application
- Includes 4 - #8 x 1-1/4" (31.75mm) steel phillips head screws



A. SMALL CORNER BASKET

8-1/4" L x 5"W x 1-5/8"D
[210mm L x 127mm W x 41mm D]

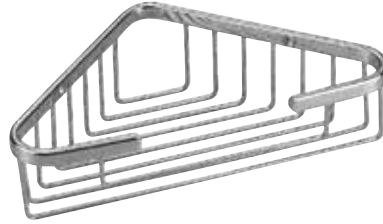

B. MEDIUM CORNER BASKET

9" L x 5-1/2"W x 2-1/2"D
[229mm L x 140mm W x 64mm D]

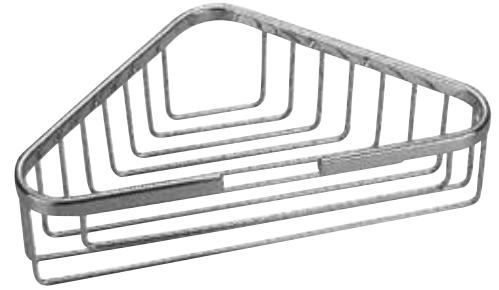

C. LARGE CORNER BASKET

13-5/8" L x 8"W x 3-1/2"D
[346mm L x 203mm W x 89mm D]

DESCRIPTION	PKG	POLISHED CHROME C26	CASE QTY
A. Small corner basket	CONTRACTOR PACK	05-1086S	6
B. Medium corner basket	CONTRACTOR PACK	05-1086M	6
C. Large corner basket	CONTRACTOR PACK	05-1086L	6

SHOWER CURTAIN HOOKS



METAL SHOWER CURTAIN HOOKS

- 12 rings per pack • Closes tight to prevent shower curtain from becoming unhooked



PLASTIC SHOWER CURTAIN HOOKS

- 12 rings per pack • Each plastic ring closes with a positive locking click

PKG	POLISHED CHROME C26	CASE QTY
POLY BAG WITH UPC LABEL	01-R9689H	20

PKG	CLEAR PLASTIC	WHITE PLASTIC	CASE QTY
RETAIL BOX	02-D9609CLR	02-D9609W	6



DELUXE METAL SHOWER CURTAIN HOOKS

- 12 hooks per pack • Each hook features 5 ball bearings for extra smooth glide • Closes tight to prevent shower curtain from becoming unhooked



SHOWER CURTAIN HOLD BACK HOOK & CHAIN

- 10-3/8" (26.5 cm) long chain • White plastic hook has integrated groove to hold down the ring on one end • Mounting screw included

PKG	POLISHED CHROME C26	CASE QTY
RETAIL BOX	02-D9610	6

PKG	WHITE PLASTIC	CASE QTY
POLY BAG WITH UPC LABEL	01-9685	25

SHOWER RODS/RETAIL SHOWER ROD KITS



A. ALUMINUM SHOWER ROD

- One-piece shower rod only
- 1" (2.5cm) outer diameter
- 0.025" (0.635mm) wall thickness
- Aluminum does not rust



B. STEEL SHOWER ROD

- One-piece shower rod only
- 1" (2.5cm) outer diameter
- 0.026" (0.660mm) wall thickness
- Chrome plated • Rust preventative treatment added



C. ADJUSTABLE LENGTH TENSION SHOWER ROD

- Extendable from 36" to 62" (92cm to 157.48cm)
- Powerful spring tension for easy installation without tools or drilling
- Plastic double-tapered center ring to prevent shower curtain rings from getting caught
- Rubber caps on both ends to prevent slipping
- Steel construction

DESCRIPTION	PKG	POLISHED CHROME C26	ALUMINUM	WHITE	CASE QTY
A. 5' (1.525 m) aluminum shower rod only	POLY SLEEVE WITH UPC LABEL	-	01-R9689	-	50
A. 6' (1.83 m) aluminum shower rod only	POLY SLEEVE WITH UPC LABEL	-	01-R9686	-	50
B. 5' (1.525 m) steel shower rod only	POLY SLEEVE WITH UPC LABEL	01-R9691	-	-	25
B. 6' (1.83 m) steel shower rod only	POLY SLEEVE WITH UPC LABEL	01-R9696	-	-	25
C. Adjustable length tension shower rod only	SHRINK WRAP WITH RETAIL LABEL	02-DP9680	-	02-DP9680W	12



D. EXTENDABLE TENSION SHOWER STALL RODS

- For shower stalls • Extends from 23" to 40" (58 cm to 101 cm)



E. EXTENDABLE TENSION SHOWER RODS

- Fits 5' & 6' bathtub stalls • Extends form 40" to 72" (102 cm to 183 cm)



F. SHOWER ROD COVER

- Wraps around existing standard 1" (2.5cm) O.D. shower rods
- Can be used to cover rusty shower rods or improve glide of shower curtain rings
- 59-5/8" (151.4cm) long

DESCRIPTION	PKG	POLISHED CHROME C26	CREAM	WHITE	CASE QTY
D. Extendable tension shower stall rod only	RETAIL HEADER CARD	02-DP9679	-	-	12
E. Extendable tension shower rod only	RETAIL HEADER CARD	02-DP9682	-	02-DP9682W	12
F. Shower rod cover	UPC LABEL	-	01-9629CR	01-9629W	20



G. ALUMINUM SHOWER ROD KIT "A"

- Comes with:
- 5' (1.524 m) one-piece aluminum shower rod
 - One pair of elliptical shaped ABS plastic flanges with exposed screw mount
 - Pack of 12 shower curtain hooks



H. ALUMINUM SHOWER ROD KIT "B"

- Comes with:
- One-piece aluminum shower rod
 - One pair of circle shaped steel flanges with concealed screw mount



I. ALUMINUM SHOWER ROD KIT "C"

- Comes with:
- One-piece aluminum shower rod
 - One pair of adjustable tension flanges

DESCRIPTION	PKG	ALUMINUM	WHITE	CASE QTY
G. 5' (1.525 m) aluminum shower rod package	POLY BAG WITH RETAIL HEADER CARD	02-D9689	-	10
H. 5' (1.525 m) aluminum shower rod package	POLY BAG WITH RETAIL HEADER CARD	02-DP9683	-	10
H. 6' (1.83 m) aluminum shower rod package	POLY BAG WITH RETAIL HEADER CARD	02-DP9684	-	10
I. 5' (1.525 m) aluminum shower rod package	POLY BAG WITH RETAIL HEADER CARD	02-D9789	02-D9789W	10
I. 6' (1.83 m) aluminum shower rod package	POLY BAG WITH RETAIL HEADER CARD	02-D9786	02-D 9786W	10

SHOWER ROD FLANGES



A. ADJUSTABLE TENSION SHOWER ROD FLANGES

- Zinc & aluminum metal alloy castin
- Allows use of one-piece shower rod without drilling holes or adhesives
- Can add up to 3/4" (1.9 cm) of tension to the shower rod
- Fits standard 1" (2.5 cm) outer diameter shower rods
- Rubber ends on both sides prevent slipping



B. ELLIPTICAL SHAPED SHOWER ROD FLANGES

- ABS construction
- Exposed screw mounting
- Fits standard 1" (2.5 cm) outer diameter shower rods
- Installation hardware included

PKG	POLISHED CHROME C26	CASE QTY
A. POLY BAG WITH UPC LABEL	01-9656	100 PRS
B. POLY BAG WITH UPC LABEL	01-R9689B	100 PRS



C. ELLIPTICAL SHAPED METAL SHOWER ROD FLANGES

- Zinc & aluminum metal alloy casting
- Exposed screw mounting
- Fits standard 1" (2.5 cm) outer diameter shower rods
- Installation hardware included



D. ROUND CONCEALED MOUNT SHOWER ROD FLANGES

- Zinc & aluminum metal alloy casting
- Concealed screw mounting
- Fits standard 1" (2.5 cm) outer diameter shower rods
- Installation hardware included

PKG	POLISHED CHROME C26	CASE QTY
C. POLY BAG WITH UPC LABEL	01-MR9689B	100 PRS
D. POLY BAG WITH RETAIL HEADER CARD	02-DP9651	50

CURVED SHOWER ROD

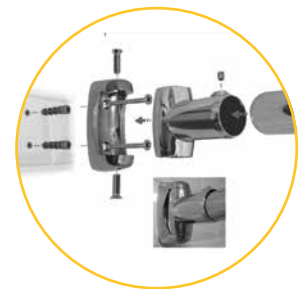

THE CRESCENT ROD™

- All curved shower rods protrude 9-1/2" (241mm) at centre

CURVED SHOWER ROD	PKG	STAINLESS STEEL C32	SATIN NICKEL C15	CASE QTY
6' shower rod - 68-1/2" L (1,740mm)	CONTRACTOR PACK	01-C9686	01-C9686SN	12
5' shower rod - 56-1/2" L (1,435mm)	CONTRACTOR PACK	01-C9689	01-C9689SN	12

CURVED SHOWER ROD REPLACEMENT PARTS	PKG	POLISHED STAINLESS STEEL C32	POLISHED CHROME C26	CASE QTY
Flanges for curved shower rod	CONTRACTOR PACK	01-RCF968	-	12
Wall cover plates for curved shower rod	CONTRACTOR PACK	-	01-C9689B	30
Screw set for curved shower rod	CONTRACTOR PACK	01-RC968	01-RC968	12

NEW!

ADJUSTABLE CURVED SHOWER ROD

- Fits showers 52" to 72" (132 cm to 183 cm)



DESCRIPTION	PKG	SATIN NICKEL C15	POLISHED CHROME C26	CASE QTY
Adjustable curved shower rod	RETAIL BOX PACK	02-D9688SN	02-D9688	4

GRAB BARS

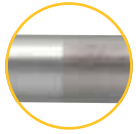

NON-SLIP PEENED GRIP

MEETS ADA STANDARDS

- Stainless steel construction
- Concealed & exposed surface mount
- Mounting hardware included
- Lifetime warranty
- Peened grip, non-slip
- ADA compliant, barrier free accessibility

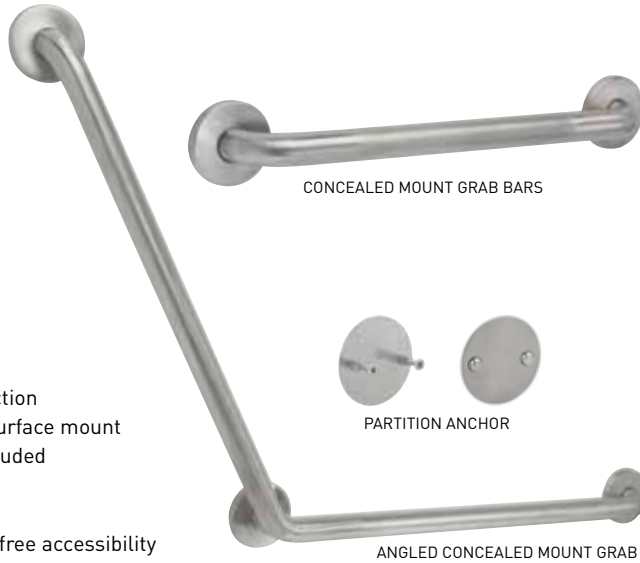

CONCEALED MOUNT GRAB BARS

PARTITION ANCHOR

ANGLED CONCEALED MOUNT GRAB BAR



FLIP-UP SAFETY RAIL



FLIP-UP SAFETY RAIL WITH PAPER HOLDER

DESCRIPTION	PKG	POLISHED STAINLESS STEEL C32 CONCEALED MOUNT	SATIN STAINLESS STEEL C32D CONCEALED MOUNT	CASE QTY
Partition anchors	CONTRACTOR PACK	-	01-R050	50
12" grab bar, 15" L (381mm)	CONTRACTOR PACK	-	01-TC220012	5
18" grab bar, 21" L (533mm)	CONTRACTOR PACK	-	01-TC220018	5
24" grab bar, 27" L (686mm)	CONTRACTOR PACK	01-TC220024PSS	01-TC220024	5
30" grab bar, 33" L (838mm)	CONTRACTOR PACK	-	01-TC220030	5
36" grab bar, 39" L (991mm)	CONTRACTOR PACK	01-TC220036PSS	01-TC220036	5
48" grab bar, 51" L (1295mm)	CONTRACTOR PACK	01-TC220048PSS	01-TC220048	5
Angled grab bar 24" x 24" x 120°, (610mm x 610mm x 120°)	CONTRACTOR PACK	-	01-TC22120	5
Flip-up safety rail	CONTRACTOR PACK	-	01-TC320011	4
Flip-up safety rail with paper holder	CONTRACTOR PACK	-	01-TC320011P	4

SPECIAL APPLICATION GRAB BARS

- Stainless steel construction
- Concealed surface mount
- Mounting hardware included
- Lifetime warranty
- ADA compliant, barrier free accessibility

*SPECIAL ORDER: CONSULT WITH YOUR SALES OR CUSTOMER SERVICE REPRESENTATIVE FOR DETAILS ON SPECIFICATION REQUIREMENTS, PRICING AND DELIVERY DATES

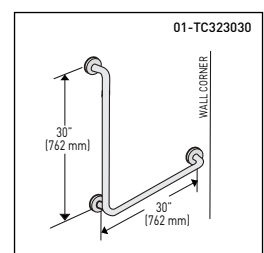
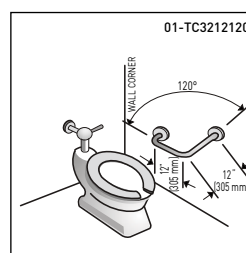
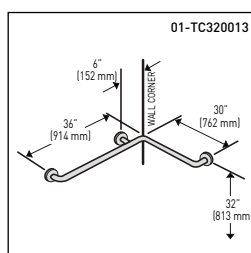
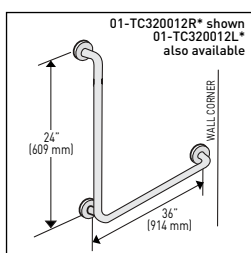
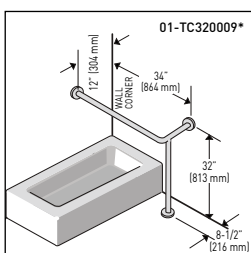
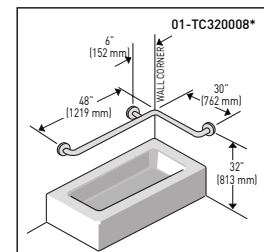
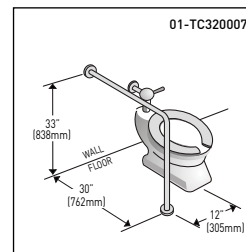
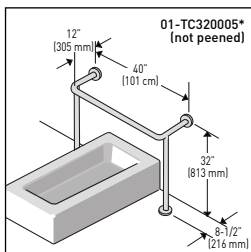
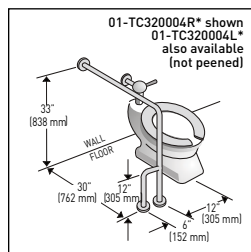
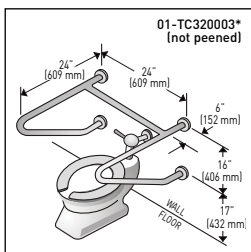
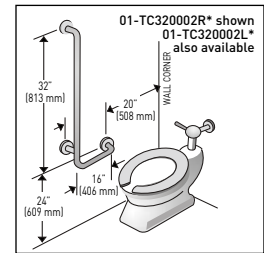
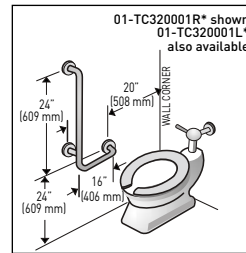

BATH HARDWARE FOR BUILDERS

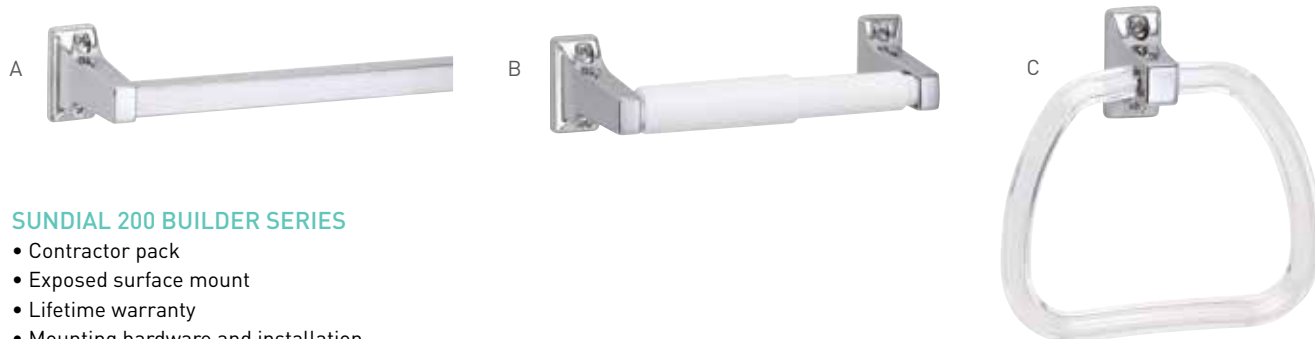

SUNDIAL 200 BUILDER SERIES

- Contractor pack
- Exposed surface mount
- Lifetime warranty
- Mounting hardware and installation instructions included

DESCRIPTION	POLISHED CHROME C26	CASE QTY
A. 18" x 5/8" towel bar - diecast post with stainless steel bar	01-20218	50
24" x 5/8" towel bar - diecast post with stainless steel bar	01-20224	50
32" x 5/8" towel bar - diecast post with stainless steel bar	01-20232	50
B. Standard paper holder with white plastic roller	01-2015	50
C. Towel ring with lucite ring	01-203	50



SUNGLOW 9400 BUILDER SERIES

- Contractor pack
- Concealed surface mount
- Lifetime warranty
- Mounting hardware and installation instructions included

DESCRIPTION	POLISHED CHROME C26	CASE QTY
A. 18" x 3/4" towel bar - diecast post with stainless steel bar	01-940018	50
24" x 3/4" towel bar - diecast post with stainless steel bar	01-940024	50
24" x 3/4" towel bar - diecast post with aluminum bar	01-A940024	50
30" x 3/4" towel bar - diecast post with stainless steel bar	01-940030	50
32" x 3/4" towel bar - diecast post with stainless steel bar	01-940032	50
36" x 3/4" towel bar - diecast post with stainless steel bar	01-940036	50
B. Single robe hook	01-9401	50
C. Double robe hook	01-9402	50
D. Towel ring	01-9404	50
E. Toothbrush & tumbler holder	01-9405	50
F. Soap dish	01-9406	50
G. Standard paper holder with white plastic roller	01-9408	50
H. Standard paper holder with chrome plastic roller	01-9409	50

BATHSETS



BASICS INFINITY

DESCRIPTION

4 piece: 24" towel bar; single robe hook; standard paper holder; towel ring

PACKAGING

Contractor

SATIN NICKEL C15

01-NC8450SN

POLISHED CHROME C26

01-NC8450

CASE QTY

10



BASICS YATES

DESCRIPTION

4 piece: 24" towel bar; double robe hook; paper/towel holder; towel ring

PACKAGING

Contractor

POLISHED CHROME C26

01-NC20450

CASE QTY

10



ORION

DESCRIPTION

4 piece: 24" towel bar; double robe hook; standard paper holder; towel ring

PACKAGING

Contractor

SATIN NICKEL C15

01-NC6050SN

POLISHED CHROME C26

01-NC6050

CASE QTY

10



NEW! ROBSON

DESCRIPTION

4 piece: 24" towel bar; single robe hook; paper/towel holder; towel ring

PACKAGING

Contractor

POLISHED CHROME C26

01-NC30950

CASE QTY

10



ULTRA

DESCRIPTION

4 piece: 24" towel bar; single robe hook; paper/towel holder; towel ring

PACKAGING

Contractor

POLISHED CHROME C26

01-NC1760

CASE QTY

10

TERMS AND CONDITIONS

TERMS

All invoices are due Net 30 days from date of invoice. Past due accounts are subject to service charge of 2% per month.

FREIGHT

- Taymor Warehouse orders are prepaid as per the following grid.

PREPAID FREIGHT ON ORDERS

\$500 or more	for British Columbia, Alberta, Saskatchewan, Manitoba, Ontario, New Brunswick, Nova Scotia & Prince Edward Island
\$750 or more	for Northern Ontario, Northern Quebec & Newfoundland/Labrador

All orders to the Northwest Territories, Yukon & Nunavut are FOB Taymor unless otherwise specified

- Warehouse orders under \$500 are FOB Taymor warehouse. Unless the method of transportation is specified at the time of order, we will use the most cost effective carrier available.
- Container Direct orders are not applicable to the above. All freight specifics for Container Direct will be detailed at the time of order.

MINIMUM ORDER

Orders under \$50 total value will be subject to an additional \$5 service charge for packing and invoicing.

BACK ORDERS

Back orders will be shipped prepaid. If back orders are not desired, specify on your original order.

SHORTAGES AND OTHER IRREGULARITIES

Unless Taymor is notified within 5 days of receipt of shipment of any shortages or irregularities regarding quantities shipped, terms or conditions of sale, it will be assumed that the customer has accepted the order as shipped and invoiced. **Customer must initiate and file a claim with the carrier for missing or damaged goods, as the carrier is responsible once they sign the bill of lading. Please note any discrepancies on the carrier's delivery slip before accepting shipment and request an inspection by the carrier.**

WARRANTY

Taymor products are warranted against defect in materials and workmanship for one full year from date of purchase from Taymor, unless otherwise specified. This warranty does not cover any defects or consequential damages caused by misuse, alteration or accidental damage. Warranty does not include any labour costs.

RETURNED GOODS POLICY

- Taymor considers all sales final.
- All returns require prior authorization. Please include R.G.A # (Returned Goods Agreement #) in each box returned complete with: item #, description, quantity, condition of goods and freight responsibility.
- All documentation including packing slips, waybills and claims must prominently state the R.G.A #.
- All unauthorized returns are subject to a 20% restocking charge, if accepted by Taymor. Contact your sales representative for further information.
- All returned goods must be in saleable condition. Products/Goods returned in shop worn or severely damaged condition and/or missing parts will not be accepted. Please contact your Taymor Sales Associate for inspection and resolution prior to returning.
- Products that have been purchased over 12 months prior to a return are subject to review by the Taymor Sales Associate prior to shipping to Taymor warehouses.
- Discontinued and special order items cannot be returned.
- Return transportation must be prepaid by the customer.
- All credits will be issued at the invoiced price at the time of original purchase.

PRICES

All prices are subject to change without notice. Errors and omissions are subject to corrections. Merchandise will be shipped at prices in effect at time of receipt of order. All prices are exclusive of GST/HST/QST and other taxes that may apply.

PHONE, FAX, E-MAIL, OR MAIL ALL PRODUCT ORDERS TO:

WESTERN CANADA

TAYMOR - VANCOUVER

1655 Derwent Way

Annacis Island, Delta, BC V3M 6K8

PHONE: 604.540.9525

FAX: 604.540.2143

TOLL FREE: 1.800.267.4774

TOLL FREE FAX: 1.800.661.6692

EMAIL: custserv@taymor.com

EASTERN CANADA

TAYMOR - TORONTO

6460 Kennedy Road

Mississauga, ON L5T 2X4

PHONE: 905.362.3660

FAX: 905.362.3661

TOLL FREE: 1.800.387.7064

TOLL FREE FAX: 1.800.567.2053

EMAIL: custsvce@taymor.com

Doorware. Bathware. Faucets. Commercial.



DISTRIBUTION CENTRES

VANCOUVER

1655 Derwent Way
Annacis Island
Delta, BC V3M 6K8

PHONE: 604.540.9525

FAX: 604.540.2143

TOLL FREE:

1.800.267.4774

TOLL FREE FAX:

1.800.661.6692

TORONTO

6460 Kennedy Road
Mississauga, ON
L5T 2X4

PHONE: 905.362.3660

FAX: 905.362.3661

TOLL FREE:

1.800.387.7064

TOLL FREE FAX:

1.800.567.2053

