



PARTS LIST

Bifold Hardware



Multi-Fold Hardware



Wall Mount Sliding Hardware



Pocket Door Hardware



Sliding Bypass Hardware



Multi-Door Sliding Hardware



JOHNSON HARDWARE

Manufacturing World Class
Door Hardware Since 1958

PL-0112

January 1, 2012

For orders call: 800-348-7616

For information call: 800-837-5664

To order by Fax: 800-837-4697

Fax: 574-294-4697

e-mail: sales@johnsonhardware.com

Web Site: www.johnsonhardware.com

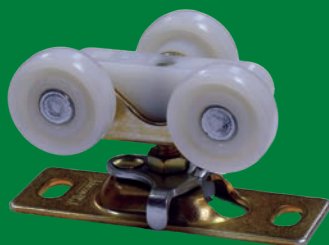

L.E. Johnson Products, Inc.
2100 Sterling Avenue
Elkhart, IN 46516

Bifold Hardware  

200FD	3
100FD	3
111FD	4
170A	4
1700	5
1718/1738/1734	5
1825	6
1838	6
1601	7

Multi-Fold Hardware  

200RD	7
100RD	8
1740	8
1700RD	8

Wall Mounted Hardware  

200WM	9
2610F/2610FB	9

Pocket Door Hardware  

2000	10
2060	10
1500	11
1560	12
2710	12
2711	13
2511	13
1510/1511	14
1521/1534	14
200PD	15
100PD	15
111PD	16
2800F	16
2800/2850	17

Closet Rods  

9000/9500	17
-----------	-------	----

Sliding Bypass Hardware  

200SD	18
100SD	18
111SD	19
138F	19
134F	20
118F	20
2200F	21
2204F	21
2222	22
2200	22
1166	23
1138	23
113F	23

Multiple-Door Hardware  

200MD	24
100MD	24
111MD	24

Door Display/Table Legs  

Door Display	25
7700	25
7800	25
88ADJ	25
88TEL	25
8800	25

Bulk Items and Retail Packs  

Bulk Track	26
Merchandisers	27
Retail Bubble Packs	28
Bulk Parts	29-32

Policy Information	32
--------------------	-------	----

200FD Surface Mounted Bifold Hardware for 1 1/8" to 1 3/4" Thick Panels to 125 lbs.

ORDERING DATA

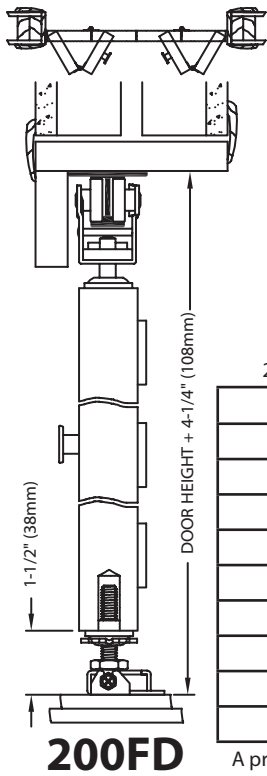

Item No.	Opening Size	Lbs/Case Qty.
200FD482	48" 2 Door	Bulk only-5/Case
200FD602	60" 2 Door	Bulk only-5/Case
200FD722	72" 2 Door	6/1
200FD962	96" 2 Door	8/1
200FD484	48" 4 Door	Bulk only-5/Case
200FD604	60" 4 Door	Bulk only-5/Case
200FD724	72" 4 Door	Bulk only-5/Case
200FD964	96" 4 Door	Bulk only-5/Case
2003	3.5x3.5 Hinge	9/10

2 Door Components

Qty	Part #
1	200 Track
1	2010 Pivot Lock
1	2001 Pivot
1	2011 Piv Socket
1	2007 Bot Piv
1	2002 Hanger
1	37 Knob
1	1712 Wrench
1/2	1808 Aligner

4 Door Components

Qty	Part #
1	200 Track
2	2010 Pivot Lock
2	2001 Pivot
2	2011 Piv Socket
2	2007 Bot Piv
2	2002 Hanger
2	37 Knob
1	1712 Wrench
1	1808 Aligner



4 Door Hardware Set Shown Below

A premium commercial bifold hardware set for 12"-48" panels up to 9'0" high. Heavy duty I-beam track with positive pivot lock, top hung, four wheel (1" dia.) ball bearing hangers, heavy duty bottom pivot, floor bracket with screw adjusting bottom pivot socket. Brass-tone steel parts. Hinges not included, order #2003 Hinges separately.

100FD Top Mounted Bifold Hardware for 1" to 1 3/4" Thick Panels to 75 lbs.

ORDERING DATA

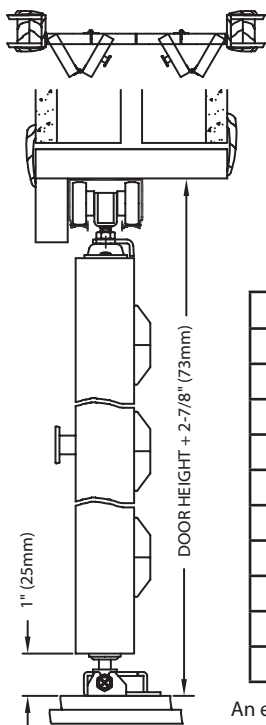

Item No.	Opening Size	Lbs/Case Qty
100FD362	36" 2 Door	15/5
100FD484	48" 4 Door	25/5
100FD604	60" 4 Door	26/5
100FD724	72" 4 Door	27/5
100FD964	96" 4 Door	21/3

Bulk 25 per Case

2 Door Components

Qty	Part #
1	100 Track
1	1155 Track Stop
1	107 Piv-Set
1	1011 Piv Socket
1	1706 Bot Piv
3	1606 Hinges
1	33 Knob
1	1125 Hanger
1	1712 Wrench
1/2	1808 Aligner

4 Door Components

Qty	Part #
1	100 Track
2	1155 Track Stop
2	107 Piv-Set
2	1011 Piv Socket
2	1706 Bot Piv
6	1606 Hinges
2	33 Knob
2	1125 Hanger
1	1712 Wrench
1	1808 Aligner



4 Door Hardware Set Shown



An excellent commercial bifold hardware set for 12"-24" panels up to 9' high weighing 75 lbs. each. Convex rail aluminum track with positive pivot lock, top hung, three wheel (1" dia.) ball bearing hangers, non-mortise lift off hinges. Floor bracket has a screw adjusting bottom pivot socket. Brass-tone steel parts.

111FD Top Mounted Bifold Hardware for 3/4" to 1 3/4" Thick Panels to 50 lbs.

ORDERING DATA

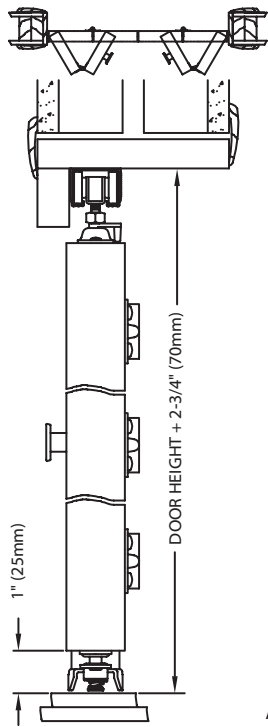

Item No.	Opening Size	Lbs/Case Qty
111FD362	36" 2 Door	11/5
111FD484	48" 4 Door	18/5
111FD604	60" 4 Door	19/5
111FD724	72" 4 Door	20/5
111FD964	96" 4 Door	16/3

Bulk 25 per Case

2 Door Components

Qty	Part #
1	111 Track
1	1155 Track Stop
1	118 Piv-Set
1	1711 Jamb Brkt
1	1707 Bot Piv
3	1703 Hinges
1	33 Knob
1	1020 Hanger
1	1712 Wrench
1/2	1808 Aligner

4 Door Components

Qty	Part #
1	111 Track
2	1155 Track Stop
2	118 Piv-Set
2	1711 Jamb Brkt
2	1707 Bot Piv
6	1703 Hinges
2	33 Knob
2	1020 Hanger
1	1712 Wrench
1	1808 Aligner



4 Door Hardware Set Shown



111FD

A superior light commercial bifold hardware set for 12"-24" panels up to 9' high weighing 50 lbs. each. Convex rail aluminum track with positive pivot lock, top hung, three wheel (3/4" dia.) hangers, four-way adjustable jamb bracket, shock absorbing "breathing" hinges self locate and automatically align to door. Brass-tone steel parts.

170A Top Mounted Bifold Hardware for 3/4" to 1 3/4" Thick Panels to 40 lbs.

ORDERING DATA

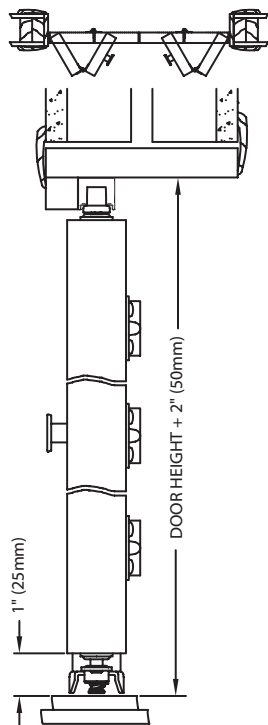

Item No.	Opening Size	Lbs/Case Qty
170A243H	24" 2 Door	9/5
170A303H	30" 2 Door	10/5
170A363H	36" 2 Door	11/5
170A486H	48" 4 Door	17/5
170A606H	60" 4 Door	18/5
170A726H	72" 4 Door	20/5
170A966H	96" 4 Door	23/5

Bulk 25 per Case

2 Door Components

Qty	Part #
1	170A Track
1	1710 Pivot Lock
1	1713 Snubber
1	1701 Top Pivot
1	1711 Jamb Brkt
1	1707 Bot Piv
3	1703 Hinges
1	33 Knob
1	1705 Top Guide
1	1712 Wrench

4 Door Components

Qty	Part #
1	170A Track
2	1710 Pivot Lock
2	1701 Top Pivot
2	1713 Snubber
2	1711 Jamb Brkt
2	1707 Bot Piv
6	1703 Hinges
2	33 Knob
2	1705 Top Guide
1	1712 Wrench
1	1808 Aligner



4 Door Hardware Set Shown

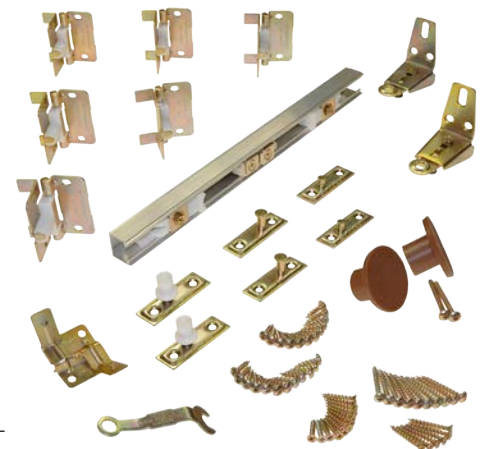

170A

A premium residential bifold hardware set. Top hung hardware allows doors to hang naturally. Automatic top of the door spacing eliminates gaps. Smooth nonbinding operation. Heavy duty aluminum track with positive pivot lock. Surface mounted pivots and guides (no hole drilling). Four way adjustable jamb bracket, shock absorbing "breathing" hinges self locate and automatically align to door. Brasstone steel parts.

1700 Top Mounted Bifold Hardware

for 3/4" to 1 3/4" Thick Panels to 40 lbs.

ORDERING DATA

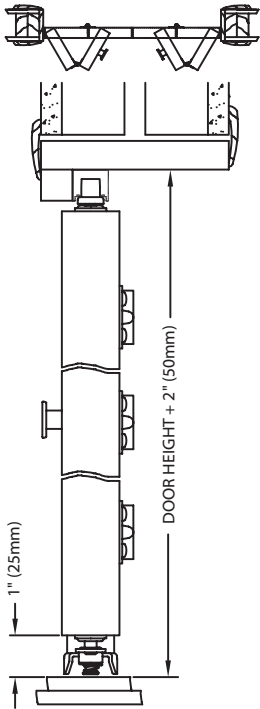

Item No.	Opening Size	Lbs/Case Qty
1700243H	24" 2 Door	9/5
1700303H	30" 2 Door	10/5
1700363H	36" 2 Door	11/5
1700486H	48" 4 Door	17/5
1700606H	60" 4 Door	18/5
1700726H	72" 4 Door	20/5
1700966H	96" 4 Door	23/5

Bulk 25 per Case

2 Door Components

Qty	Part #
1	1700 Track
1	1710 Pivot Lock
1	1713 Snubber
1	1711 Jamb Brkt
1	1707 Bot Piv
3	1703 Hinges
1	33 Knob
1	1705 Top Guide
1	1712 Wrench

4 Door Components

Qty	Part #
1	1700 Track
2	1710 Pivot Lock
1	1713 Snubber
2	1711 Jamb Brkt
2	1707 Bot Piv
6	1703 Hinges
2	33 Knob
2	1705 Top Guide
1	1712 Wrench
1	1808 Aligner

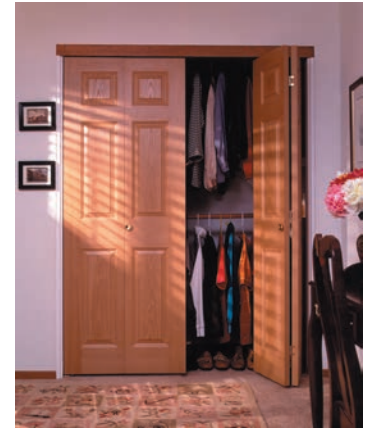

4 Door Hardware Set Shown



Same features as the 170A, but with woodtone steel track.

Also available with white track. (Bulk Only)

1718/1734/1738 Side Mount Bifold

Hdwe 1734=3/4", 1718=1 1/8", 1738=1 3/8" to 40 lbs.

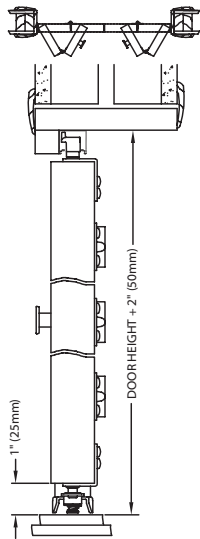

1738

4 Door Hardware Set Shown



Same features as 1700 series, except hardware is mounted to back side of door. Side mount plates can be adjusted if opening is slightly out of square. Top pivot and guide must be kept parallel with track. Track also available in white.

ORDERING DATA

Specify	Opening Size	Lbs./Case Qty
	24" 2 Door	(Bulk only)
	30" 2 Door	packed 25
1734=3/4"	36" 2 Door	per carton)
1718=1 1/8"	48" 4 Door	
1738=1 3/8"	60" 4 Door	(Bulk only)
	72" 4 Door	packed 25
	96" 4 Door	per carton)

1770 Side Mount Bifold Hardware

for 3/4" Thick Panels to 40 lbs.

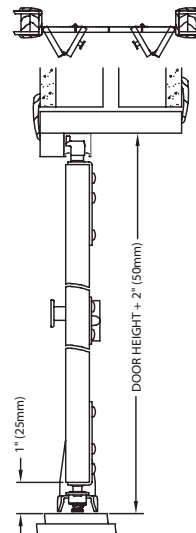

1770

2 Door Hardware Set Shown



Same features as 1718/1734/1738 but for 3/4" doors only. Pivot and guide plate are 1/4" longer than 1718/1734/1738 plates. Track also available in white.

ORDERING DATA

Item No.	Opening Size	Lbs./Case Qty
1770243H	24" 2 Door	(Bulk only)
1770303H	30" 2 Door	packed 25
1770363H	36" 2 Door	per carton)
1770486H	48" 4 Door	
1770606H	60" 4 Door	(Bulk only)
1770726H	72" 4 Door	packed 25
1770966H	96" 4 Door	per carton)

1825 Tap-In Bifold Hardware (7/16" pin) for 1 1/8" to 1 3/4" Thick Panels to 35 lbs.



ORDERING DATA

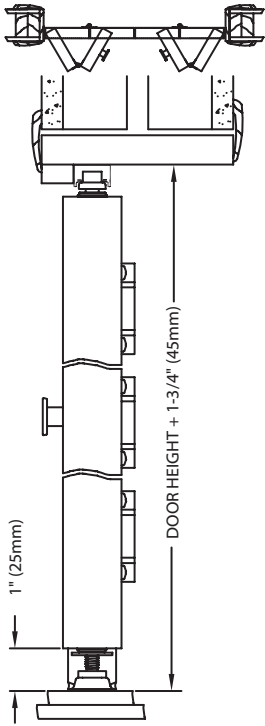

Item No.	Opening Size	Lbs./Case Qty
1825243H	24" 2 Door	(Bulk only
1825303H	30" 2 Door	packed 25
1825323H	32" 2 Door	per carton)
1825363H	36" 2 Door	8/5
1825486H	48" 4 Door	12/5
1825606H	60" 4 Door	13/5
1825726H	72" 4 Door	15/5
1825966H	96" 4 Door	17/5

2 Door Components

Qty	Part #
1	1825 Track
1	1810 Pivot
1	1713 Snubber
1	1811 Jamb Brkt
1	1807 Bot Piv
3	1805 Hinges
1	33 Knob
2	1801 Top Guide
1	1712 Wrench

4 Door Components

Qty	Part #
1	1825 Track
2	1810 Pivot Lock
2	1713 Snubber
2	1811 Jamb Brkt
2	1807 Bot Piv
6	1805 Hinges
2	33 Knob
4	1801 Top Guide
1	1712 Wrench
1	1808 Aligner



4 Door Hardware Set Shown



1825

Low profile woodtone steel track. Pivots and guides have a needle bearing surface to minimize friction. Jamb bracket has an adjustable bottom pivot bearing socket. Hinges are self locating and automatically align to door. Brass-tone steel parts.

1838 Tap-In Bifold Hardware (3/8" pin) for 1 1/8" to 1 3/4" Thick Panels to 30 lbs.



ORDERING DATA

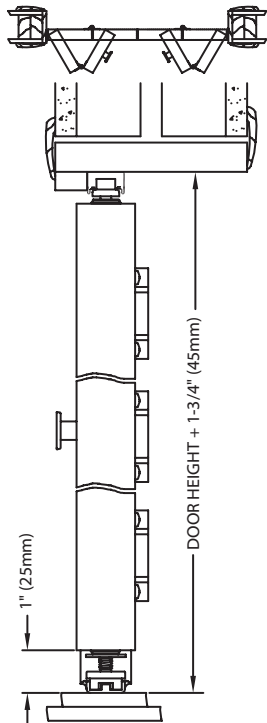

Item No.	Opening Size	Lbs./Case Qty
1838243H	24" 2 Door	(Bulk only
1838303H	30" 2 Door	packed 25
1838323H	32" 2 Door	per carton)
1838363H	36" 2 Door	
1838486H	48" 4 Door	(Bulk only
1838606H	60" 4 Door	packed 25
1838726H	72" 4 Door	per carton)
1838966H	96" 4 Door	

2 Door Components

Qty	Part #
1	1825 Track
1	1810 Pivot
1	1812 Snubber
1	1861 Jamb Brkt
1	1837 Bot Piv
3	1805 Hinges
1	37 Knob
2	1831 Top Guide
1	1712 Wrench

4 Door Components

Qty	Part #
1	1825 Track
2	1810 Pivot
1	1814 Snubber
2	1861 Jamb Brkt
2	1837 Bot Piv
6	1805 Hinges
2	37 Knob
4	1831 Top Guide
1	1712 Wrench
1	1808 Aligner



4 Door Hardware Set Shown



1838

Low profile white steel track. Pivots and guides have a needle bearing surface to minimize friction. Jamb bracket has positive positioning bottom pivot bearing socket. Hinges are self locating and automatically align to door. Brass-tone steel parts.

1601 Full Access Bifold Hardware for 3/4" to 1 3/4" Thick Panels to 30 lbs.



ORDERING DATA

Item No.	Opening Size	Lbs./Case Qty
1601912P	18"-24" 2 Door	(Bulk only packed 25/Carton)
1601218P	24"-36" 2 Door	8/5
1601824P	36"-48" 2 Door	10/5

For 4 Door Openings, Order 2 Kits and Double the Opening Size

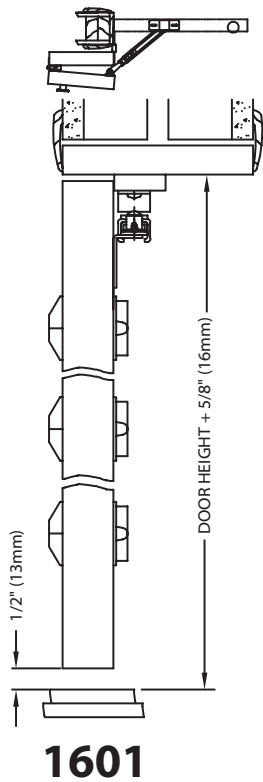

Retail Box



Package Components

Qty	Part #
1	1601 Control Arm
1	1513 Bumper
1/2	1808 Aligner
3	1605 Hinge/Woodtone
3	1703 Hinges
1	33 Knob



2 Door Hardware Set Shown



Unique bifold provides full jamb to jamb access. Doors fold 180 degrees and lay flat against the wall. No top track. Comes with woodtone, non-mortise, lift off, jamb hinges (mortised hinges can be used at jamb). Woodtone Control Arm, brass-tone steel parts. White, non-mortise, lift off, jamb hinges are available in bulk.

200RD Multi Folding Hardware for 1 1/8" to 1 3/4" Thick Panels to 75 lbs.



ORDERING DATA

Specify	Description	Lbs./Case Qty
200	Track Only	See Page 26 For Sizes
2015BS-A	Basic Set (1st Pair of Doors)	3/1
2002PLBG	Add-On Set B (2nd and 3rd Pair)	28/25
2003 Hinge (Pair)	3.5"X3.5" Mortised Hinges	9/10 Pair

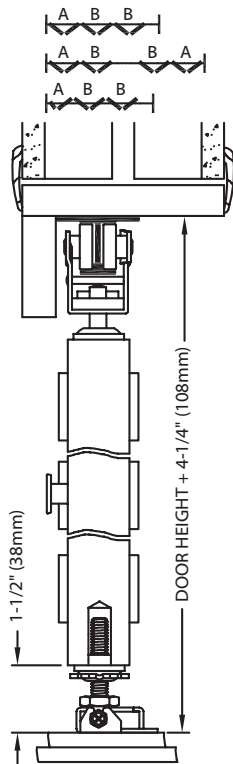

2015BS-A Components

Qty	Part #
1	2001 Top Pivot
1	2010 Pivot Lock
1	2002 Door Guide
1	2007 Bottom Pivot
1	2011 Pivot Bracket
1	37 Knob
1	1712 Wrench

Hinges Not Included Buy Mortised Hinges Separately

2002 PLBG Set B Components

Qty	Part #
1	2002 Door Guide

Hinges Not Included Buy Mortised Hinges Separately



2015BS-A Components



2002 PLBG Set B Components

Hardware for panels 12"-36" up to 9'0" high. Heavy duty I-beam track with positive pivot-lock, top hung, four wheel (1" dia.) ball bearing hangers, heavy duty bottom pivot, floor bracket with screw adjusting bottom pivot socket. Brass-tone steel parts.

(Maximum: Six panels each way.)
2003 Hinges must be ordered separately.





ORDERING DATA

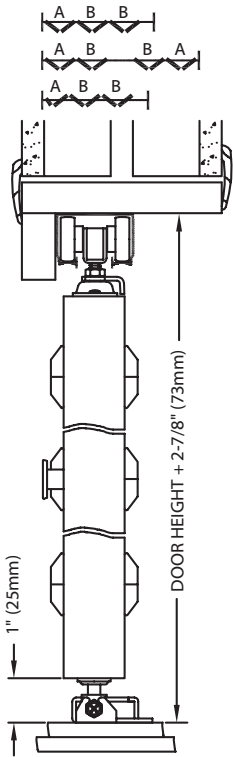

Specify	Description	Lbs./Case Qty
100	Track Only	See Page 26 For Sizes
1015BS-A	Basic Set (1st Pair of Doors)	1.5/1
1030AOSB	Add-On Set B (2nd and 3rd Pair)	1.4/1

1015BS-A Components

Qty	Part #
1	1001 Top Pivot
1	1010 Pivot Lock
1	1125 Door Guide
1	1706 Bottom Pivot
1	1011 Pivot Bracket
3	1606 Hinges
1	1155 Track Stop
1	33 Knob
1	1712 Wrench

1030AOSB Components

Qty	Part #
1	1125 Door Guide
6	1606 Hinges
1	33 Knob
1	1712 Wrench



1015BS-A Components



1030AOSB Components



100RD

Hardware for panels 12"-24" up to 9'0" high. Convex rail aluminum track with positive pivot lock, top hung, three wheel (1" dia.) ball bearing hangers, non-mortise lift off hinges. Floor bracket has a screw for adjusting bottom pivot socket. Brass-tone steel parts.

(Maximum: Six panels each way).

ORDERING DATA

ORDERING DATA

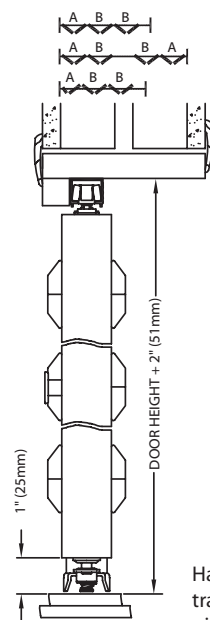

1715BS-A Components

Qty	Part #
1	1701 Top Pivot
1	1710 Pivot Lock
1	1742 Door Guide
1	1707 Bot. Pivot
1	1711 Piv. Bracket
3	1606 Hinges
1	1713 Track Stop
1	33 Knob
1	1712 Wrench

1725AOSB Components

Qty	Part #
6	1606 Hinges
1	1742 Door Guide
1	33 Knob



1715BS-A Components



1725AOSB Components

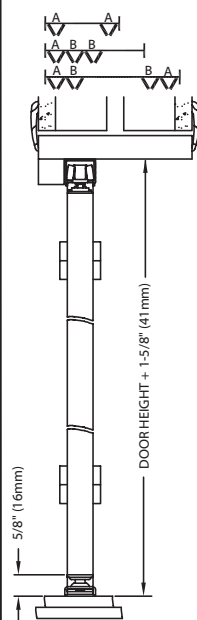

1740BS-A Components

Qty	Part #
1	1701 Top Pivot
1	1710 Pivot Lock
1	1742 Door Guide
1	1707 Bot. Pivot
1	1711 Piv. Bracket
2	1743 Hinges
1	1713 Track Stop
1	33 Knob
1	1712 Wrench

1740-AOS Components

Qty	Part #
4	1743 Hinges
1	1742 Door Guide
1	33 Knob



1740BS-A Components



1740-AOS Components



1700RD

1740RD

Hardware for panels 9" to 18" up to 6'8" high. Aluminum track with positive pivot lock, top hung, surface mounted pivots/hangers, four way adjustable jamb bracket, four wheel (7/16" dia.) hanger, non-mortise lift off hinges. Brass-tone steel parts. (Maximum: Six panels each way).

Hardware for panels 9" to 18" up to 6'8" high. Aluminum track with positive pivot lock, top hung, surface mounted pivots/hangers, four way adjustable jamb bracket, four wheel (7/16" dia.) hanger, non-mortise lift off hinges. Brass-tone steel parts. (Maximum: Six panels each way).

Specify	Description	Lbs./Case Qty
170A	Track Only	See Page 26 For Sizes
1715BS-A	Basic Set (1st Pair of Doors)	1/1
1725AOSB	Add-On Set B (2nd and 3rd Pair)	1.2/1

Specify	Description	Lbs./Case Qty
170A	Track Only	See Page 26 For Sizes
1740BS-A	Basic Set (1st Pair of Doors)	5.5/10
1740-AOS	Add-On Set B (2nd and 3rd Pair)	2.4/10

200WM Wall Mounted Track and Hardware

for a minimum 1 1/8" or Thicker Door to 300 lbs.



ORDERING DATA

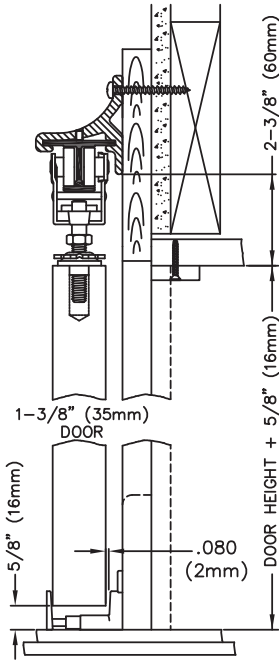

Item No.	Max Door Size	Lbs./Case Qty
200WM481	One 2'0" Door	7/1
200WM601	One 2'6" Door	8/1
200WM721	One 3'0" Door	9/1
200WM961	One 4'0" Door	11/1

200WM481 and 200WM601 Components Bulk 5 per Case

Qty	Part #	Qty	Part #
1	200 Track	1	12 Door Guide
4	2006 Brackets	2	2031 Guides
2	2020 Hangers	1	1712 Wrench
2	2055 Trk Stops	1	3/32" Wrench

200WM721 Components

Qty	Part #	Qty	Part #
1	200 Track	1	12 Door Guide
5	2006 Brackets	2	2031 Guides
2	2020 Hangers	1	1712 Wrench
2	2055 Trk Stops	1	3/32" Wrench

200WM961 Components

Qty	Part #	Qty	Part #
1	200 Track	1	12 Door Guide
6	2006 Brackets	2	2031 Guides
2	2020 Hangers	1	1712 Wrench
2	2055 Trk Stops	1	3/32" Wrench



200WM

A unique surface mounted hardware set for open pocket doors. Use to slide door along the wall rather than in the wall. Features a heavy duty I-beam track, extruded aluminum wall mounting brackets to anchor the track to the wall studs, four wheel (1" dia.), smooth operating, ball bearing hangers, and two different guides to stabilize the door. Brass-tone steel parts. Tracks available up to 192".

2610F Wall Mounted Fascia Track and Hardware

for a 1" to 1 3/4" Thick Door to 125 lbs. (200 lbs. w/ 1125 Hanger)



ORDERING DATA

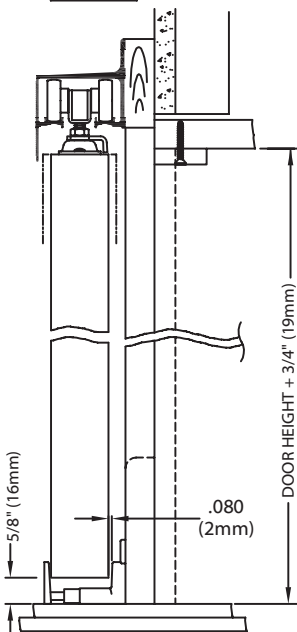

2610F

Item No.	Max Door Size	Lbs./Case Qty
2610F481	One 2'0" Door	21/4
2610F601	One 2'6" Door	25/4
2610F721	One 3'0" Door	30/4
2610F961	One 4'0" Door	42/5

2610F Set Components

Qty	Part #
1	2610F Track
2	1120 Hangers
2	1155 Trk Stops
1	12 Guide
2	2680 End Caps
1	1712 Wrench

A unique surface mounted hardware set for open pocket doors. Use to slide a door along the wall rather than in the wall. Aluminum track with convex rails, jump proof three wheel (1" dia.) hangers assure a smooth quiet operation. Also includes a wall-mounted door guide. Brass-tone steel parts. Optional #1125 hanger for doors up to 200 lbs.

Bulk 10 per Case

Also Available in Dark Bronze/200 lbs. Rating



Item No.	Max Door Size	Lbs./Case Qty
2610F48B	One 2'0" Door	5/1
2610F60B	One 2'6" Door	6/1
2610F72B	One 3'0" Door	7/1
2610F96B	One 4'0" Door	9/1

Bulk 10 per Case



2000 Commercial Grade Pocket Door Frame for 1 1/8" to 1 3/4" Thick Doors to 300 lbs.



ORDERING DATA

For 2 x 4 construction. Aluminum 1" Beam track, smooth quiet operation, rust resistant steel reinforced wood split studs, jump proof 4 wheel ball bearing (1" dia.) hangers, self-adjusting floor anchors, 2'6" and 3'0" headers marked to cut to smaller door sizes. Brass-tone steel parts.

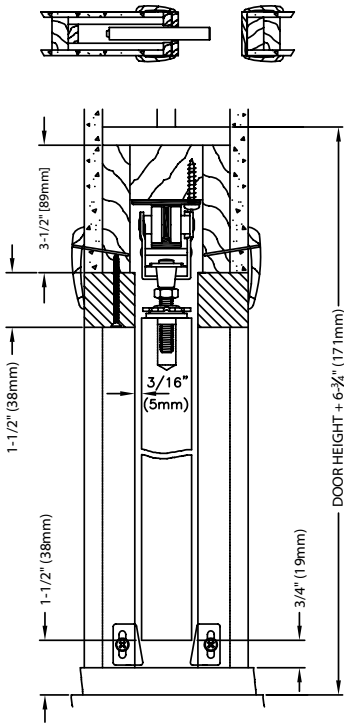

2000



2000 Series Pocket Door Frame Prices

Item No.	Max Door Size	lbs/Case
Frames for 80" Tall Doors		
202668PF	For Doors up to 30" wide x 80" tall	42/1
203068PF	For Doors up to 36" wide x 80" tall	44/1
204068PF	For Doors up to 48" wide x 80" tall	63/1
205068PF	For Doors up to 60" wide x 80" tall	81/1
Frames for 84" Tall Doors		
202670PF	For Doors up to 30" wide x 84" tall	43/1
203070PF	For Doors up to 36" wide x 84" tall	45/1
204070PF	For Doors up to 48" wide x 84" tall	65/1
205070PF	For Doors up to 60" wide x 84" tall	83/1
Frames for 96" Tall Doors		
202680PF	For Doors up to 30" wide x 96" tall	47/1
203080PF	For Doors up to 36" wide x 96" tall	49/1
204080PF	For Doors up to 48" wide x 96" tall	70/1
205080PF	For Doors up to 60" wide x 96" tall	90/1
Frames for 108" Tall Doors		
202690PF	For Doors up to 30" wide x 108" tall	50/1
203090PF	For Doors up to 36" wide x 108" tall	52/1
204090PF	For Doors up to 48" wide x 108" tall	75/1
205090PF	For Doors up to 60" wide x 108" tall	97/1
Accessory		
2050PLBG	Converging Door Kit	10/10

2060 Commercial Grade Pocket Door Frame for 1 1/8" to 2 1/4" Thick Doors to 300 lbs. (2" x 6" Stud Wall)



ORDERING DATA

For 2 x 6 Construction. Heavy duty pocket door frame featuring heavy gauge all steel split studs for maximum wall rigidity. New all steel split stud design makes a pocket door wall sheeted with standard wall board material comparable in stiffness to standard non pocket door stud walls and eliminates warpage. The 2060 is designed like the rest of our pocket door frames so it can be used for single or converging pocket door applications. The 2060 is packaged for easy transport and fast installation in standard 2 X 6 timber or steel framed stud walls. Versatile frames can be adapted for use in thicker walls, block walls and cut down to accept any smaller door size.

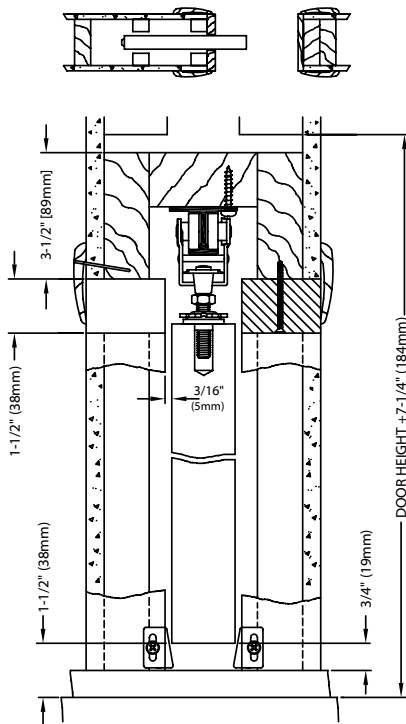

2060



2060 Series Pocket Door Frame Prices

Item No.	Max Door Size	lbs/Case
Frames for 80" Tall Doors		
20602668	For Doors up to 30" wide x 80" tall	52/1
20603068	For Doors up to 36" wide x 80" tall	55/1
20604068	For Doors up to 48" wide x 80" tall	78/1
20605068	For Doors up to 60" wide x 80" tall	99/1
Frames for 84" Tall Doors		
20602670	For Doors up to 30" wide x 84" tall	53/1
20603070	For Doors up to 36" wide x 84" tall	56/1
20604070	For Doors up to 48" wide x 84" tall	80/1
20605070	For Doors up to 60" wide x 84" tall	102/1
Frames for 96" Tall Doors		
20602680	For Doors up to 30" wide x 96" tall	58/1
20603080	For Doors up to 36" wide x 96" tall	61/1
20604080	For Doors up to 48" wide x 96" tall	87/1
20605080	For Doors up to 60" wide x 96" tall	111/1
Frames for 108" Tall Doors		
20602690	For Doors up to 30" wide x 108" tall	62/1
20603090	For Doors up to 36" wide x 108" tall	65/1
20604090	For Doors up to 48" wide x 108" tall	94/1
20605090	For Doors up to 60" wide x 108" tall	120/1
Accessory		
2050PLBG	Converging Door Kit	10/10



ORDERING DATA

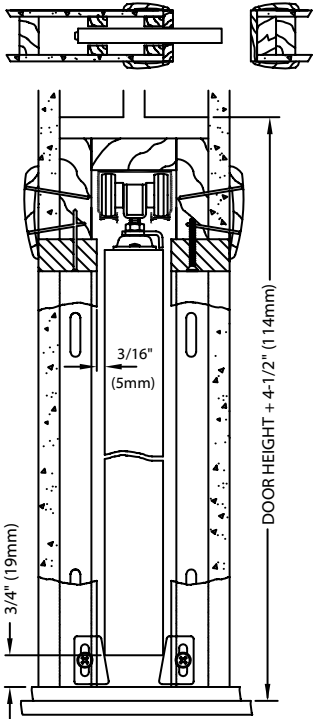

For 2 x 4 Construction. Removable aluminum track with convex rails for smooth quiet operation, rust resistant steel reinforced wood split studs, jump proof three wheel (1" dia.) hangers, self adjusting floor anchors, 2'6" and 3'0" headers marked to cut to smaller door sizes. Brass-tone steel parts. All frames for doors up to 1 3/8" can be converted for 1 3/4" doors with 1575PPK3 adaptor kit. All oversized frames include 1575PPK3 adaptor kit.



1500

Item No.	Description	lbs/Case
Accessories		
1500PPK3	Replacement Hardware Kit	5/10
1555PPK3	Converging Door Kit	3/10
1575PPK3	1-3/4" Door Adapter Kit	3/10
Steel Wrapped Uprights		
Please Note: 3'6" and 4'0" Frames have 1 extra pair of uprights. 4'6" and 5'0" Frames have 2 extra pairs of uprights.		
1568UPRT	80" Upright Pair with 1 3/8" Floor Bracket	72/6
1570UPRT	84" Upright Pair with 1 3/8" Floor Bracket	75/6
1580UPRT	96" Upright Pair with 1 3/8" Floor Bracket	86/6
1590UPRT	108" Upright Pair with 1 3/8" Floor Bracket	96/6
Hangers		
1120	Standard Hanger, max weight 125 lbs.	13/50
1125	Ball-Bearing Hanger, max weight 200 lbs.	23/50
1121	Hanger Plate w/ screws	9/100

1500 Series Pocket Door Frame Prices

Item No.	Max Door Size	lbs/Case
Frames for 80" Tall Doors up to 125 lbs.		
152068PF	For Doors up to 24" wide x 80" tall x 1 3/8"	28/1
152468PF	For Doors up to 28" wide x 80" tall x 1 3/8"	29/1
152668PF	For Doors up to 30" wide x 80" tall x 1 3/8"	30/1
152868PF	For Doors up to 32" wide x 80" tall x 1 3/8"	30/1
153068PF	For Doors up to 36" wide x 80" tall x 1 3/8"	30/1
Frames for 80" Tall Doors up to 200 lbs. (Uses 1125 Ball Bearing Hanger)		
152068HD	For Doors up to 24" wide x 80" tall x 1 3/8"	28/1
152468HD	For Doors up to 28" wide x 80" tall x 1 3/8"	29/1
152668HD	For Doors up to 30" wide x 80" tall x 1 3/8"	30/1
152868HD	For Doors up to 32" wide x 80" tall x 1 3/8"	30/1
153068HD	For Doors up to 36" wide x 80" tall x 1 3/8"	30/1
Frames Below include 1575 1 3/4" Adaptor Kit		
153668PF	For Doors up to 42" wide x 80" tall x 1 3/8"	40/1
154068PF	For Doors up to 48" wide x 80" tall x 1 3/8"	42/1
154668PF	For Doors up to 54" wide x 80" tall x 1 3/8"	54/1
155068PF	For Doors up to 60" wide x 80" tall x 1 3/8"	55/1
Frames for 84" Tall Doors up to 200 lbs. (Uses 1125 Ball Bearing Hanger)		
152070PF	For Doors up to 24" wide x 84" tall x 1 3/8"	32/1
152470PF	For Doors up to 28" wide x 84" tall x 1 3/8"	34/1
152670PF	For Doors up to 30" wide x 84" tall x 1 3/8"	35/1
152870PF	For Doors up to 32" wide x 84" tall x 1 3/8"	37/1
153070PF	For Doors up to 36" wide x 84" tall x 1 3/8"	39/1
153670PF	For Doors up to 42" wide x 84" tall x 1 3/8"	43/1
154070PF	For Doors up to 48" wide x 84" tall x 1 3/8"	50/1
154670PF	For Doors up to 54" wide x 84" tall x 1 3/8"	57/1
155070PF	For Doors up to 60" wide x 84" tall x 1 3/8"	61/1
Frames for 96" Tall Doors up to 200 lbs. (Uses 1125 Ball Bearing Hanger)		
152080PF	For Doors up to 24" wide x 96" tall x 1 3/8"	35/1
152480PF	For Doors up to 28" wide x 96" tall x 1 3/8"	39/1
152680PF	For Doors up to 30" wide x 96" tall x 1 3/8"	40/1
152880PF	For Doors up to 32" wide x 96" tall x 1 3/8"	41/1
153080PF	For Doors up to 36" wide x 96" tall x 1 3/8"	43/1
153680PF	For Doors up to 42" wide x 96" tall x 1 3/8"	44/1
154080PF	For Doors up to 48" wide x 96" tall x 1 3/8"	50/1
154680PF	For Doors up to 54" wide x 96" tall x 1 3/8"	59/1
155080PF	For Doors up to 60" wide x 96" tall x 1 3/8"	62/1
Frames for 108" Tall Doors up to 200 lbs. (Uses 1125 Ball Bearing Hanger)		
152090PF	For Doors up to 24" wide x 108" tall x 1 3/8"	38/1
152490PF	For Doors up to 28" wide x 108" tall x 1 3/8"	40/1
152690PF	For Doors up to 30" wide x 108" tall x 1 3/8"	41/1
152890PF	For Doors up to 32" wide x 108" tall x 1 3/8"	42/1
153090PF	For Doors up to 36" wide x 108" tall x 1 3/8"	44/1
153690PF	For Doors up to 42" wide x 108" tall x 1 3/8"	56/1
154090PF	For Doors up to 48" wide x 108" tall x 1 3/8"	62/1
154690PF	For Doors up to 54" wide x 108" tall x 1 3/8"	72/1
155090PF	For Doors up to 60" wide x 108" tall x 1 3/8"	80/1



1560 Commercial Grade Pocket Door Frame for 1" to 3" Thick Doors to 200 lbs. (2" x 6" Stud Wall)



ORDERING DATA

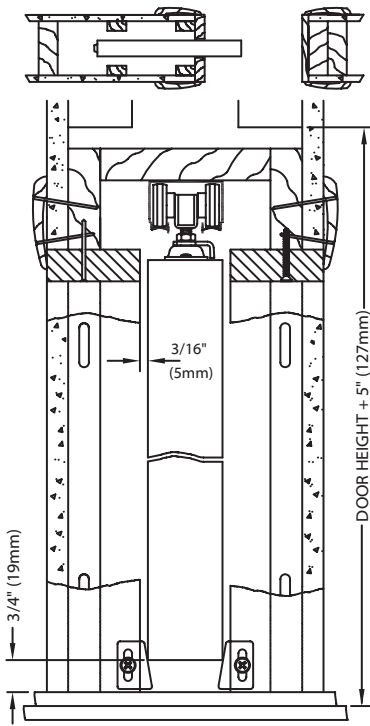

For 2 x 6 Construction. Removable aluminum track with convex rails, rust resistant steel reinforced wood split studs, jump proof three wheel (1" dia.) ball bearing hangers, self-adjusting floor anchors, headers marked to cut to smaller door sizes. Brass-tone steel parts.



1560

1560 Series Pocket Door Frame Prices

Item No.	Max Door Size	lbs/Case
Frames for 80" Tall Doors		
15602668	For Doors up to 30" wide x 80" tall	31/1
15603068	For Doors up to 36" wide x 80" tall	33/1
15604068	For Doors up to 48" wide x 80" tall	58/1
*15605068	For Doors up to 60" wide x 80" tall	73/1
Frames for 84" Tall Doors		
15602670	For Doors up to 30" wide x 84" tall	38/1
15603070	For Doors up to 36" wide x 84" tall	40/1
15604070	For Doors up to 48" wide x 84" tall	61/1
*15605070	For Doors up to 60" wide x 84" tall	77/1
Frames for 96" Tall Doors		
15602680	For Doors up to 30" wide x 96" tall	41/1
15603080	For Doors up to 36" wide x 96" tall	43/1
15604080	For Doors up to 48" wide x 96" tall	66/1
*15605080	For Doors up to 60" wide x 96" tall	85/1
Frames for 108" Tall Doors		
*15602690	For Doors up to 30" wide x 108" tall	45/1
*15603090	For Doors up to 36" wide x 108" tall	47/1
*15604090	For Doors up to 48" wide x 108" tall	71/1
*15605090	For Doors up to 60" wide x 108" tall	92/1
Accessory		
1555PPK3	Converging Door Kit	6/10

2710 Fabricated Pocket Door Frame for 1" to 1 3/8" Thick Doors to 125 lbs. (200 lbs. with 1125 Hanger)



ORDERING DATA

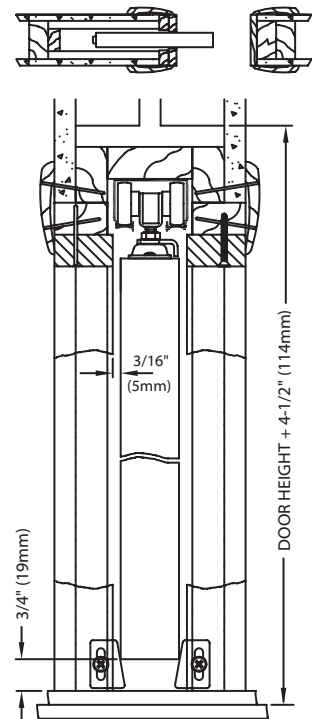

A "pre-assembled" pocket door frame with 10 horizontal members for 2" x 4" construction. Removable aluminum track with convex rails, jump proof three wheel (1" dia.) hangers. Brass-tone steel parts. *Optional hanger #1125 available for doors to 200 lbs.*



2710

2710 Series Pocket Door Frame Prices

Item No.	Max Door Size	lbs/Case
Frames for 80" Tall Doors up to 125 lbs.		
27102068	For Doors up to 24" wide x 80" tall x 1 1/8"	23/1
27102468	For Doors up to 28" wide x 80" tall x 1 1/8"	26/1
27102668	For Doors up to 30" wide x 80" tall x 1 1/8"	27/1
27102868	For Doors up to 32" wide x 80" tall x 1 1/8"	28/1
27103068	For Doors up to 36" wide x 80" tall x 1 1/8"	31/1
Frames for 80" Tall Doors up to 200 lbs. (Uses 1125 Ball Bearing Hanger)		
27H02068	For Doors up to 24" wide x 80" tall x 1 1/8"	23/1
27H02468	For Doors up to 28" wide x 80" tall x 1 1/8"	26/1
27H02668	For Doors up to 30" wide x 80" tall x 1 1/8"	27/1
27H02868	For Doors up to 32" wide x 80" tall x 1 1/8"	28/1
27H03068	For Doors up to 36" wide x 80" tall x 1 1/8"	31/1
Frames for 84" Tall Doors up to 200 lbs. (Uses 1125 Ball Bearing Hanger)		
27102070	For Doors up to 24" wide x 84" tall x 1 1/8"	30/1
27102470	For Doors up to 28" wide x 84" tall x 1 1/8"	33/1
27102670	For Doors up to 30" wide x 84" tall x 1 1/8"	34/1
27102870	For Doors up to 32" wide x 84" tall x 1 1/8"	38/1
27103070	For Doors up to 36" wide x 84" tall x 1 1/8"	39/1
Frames for 96" Tall Doors up to 200 lbs. (Uses 1125 Ball Bearing Hanger)		
27102080	For Doors up to 24" wide x 96" tall x 1 1/8"	38/1
27102480	For Doors up to 28" wide x 96" tall x 1 1/8"	42/1
27102680	For Doors up to 30" wide x 96" tall x 1 1/8"	43/1
27102880	For Doors up to 32" wide x 96" tall x 1 1/8"	47/1
27103080	For Doors up to 36" wide x 96" tall x 1 1/8"	48/1

Item No.	Description	lbs/Case
Accessories		
1500PPK3	Replacement Hardware Kit (125 lbs.)	5/10
1555PPK3	Converging Door Kit	6/10

2711 Fabricated Pocket Door Frame for 3/4" to 1 3/8" Thick Doors to 80 lbs. (150 lbs. with 1025 Hanger)



ORDERING DATA

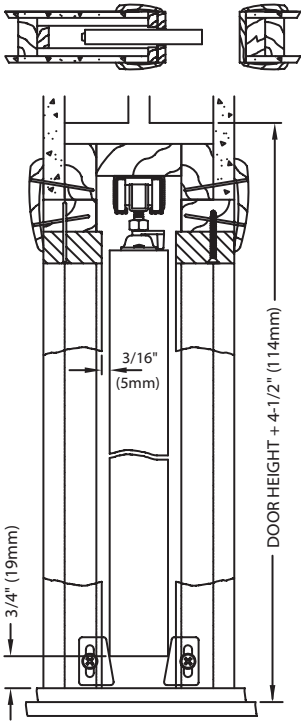

A "pre-assembled" pocket door frame with 10 horizontal members for 2" x 4" construction. Removable aluminum track with convex rails, jump proof three wheel (3/4" dia.) hangers. Brass-tone steel parts. *Optional hanger #1025 available for doors to 150 lbs.*



2711

2711 Series Pocket Door Frame Prices

Item No.	Max Door Size	lbs/Case
Frames for 80" Tall Doors up to 125 lbs.		
27112068	For Doors up to 24" wide x 80" tall x 1 3/8"	23/1
27112468	For Doors up to 28" wide x 80" tall x 1 3/8"	26/1
27112668	For Doors up to 30" wide x 80" tall x 1 3/8"	27/1
27112868	For Doors up to 32" wide x 80" tall x 1 3/8"	28/1
27113068	For Doors up to 36" wide x 80" tall x 1 3/8"	31/1
Frames for 80" Tall Doors up to 200 lbs. (Uses 1025 Ball Bearing Hanger)		
27H12068	For Doors up to 24" wide x 80" tall x 1 3/8"	23/1
27H12468	For Doors up to 28" wide x 80" tall x 1 3/8"	26/1
27H12668	For Doors up to 30" wide x 80" tall x 1 3/8"	27/1
27H12868	For Doors up to 32" wide x 80" tall x 1 3/8"	28/1
27H13068	For Doors up to 36" wide x 80" tall x 1 3/8"	31/1
Accessories		
2511PPK3	Replacement Hardware Kit (80 lbs.)	3/10
1555PPK3	Converging Door Kit	6/10



2511 Commercial Grade Pocket Door Frame for 3/4" to 1 3/8" Thick Doors (1 3/4" with 1575 Adaptor Kit) to 80 lbs. (150 lbs. with 1025 Hanger)



ORDERING DATA

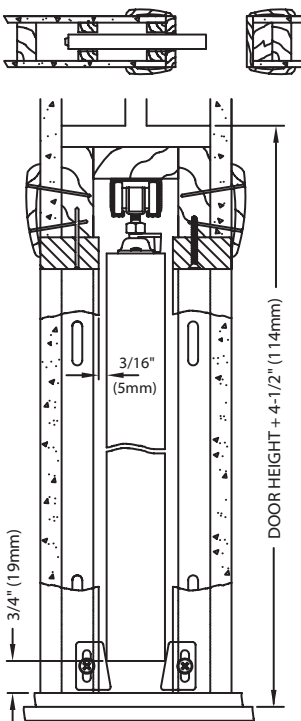

For 2 x 4 Construction. Removable aluminum track with convex rails for smooth quiet operation, rust resistant steel reinforced wood split studs, jump proof three wheel (3/4" dia.) hangers, self adjusting floor anchors, 2'6" and 3'0" headers marked to cut to smaller door sizes. Brass-tone steel parts. All frames for doors up to 1 3/8" can be converted for 1 3/4" doors with 1575PPK3 adaptor kit. Very similar to 1500 Series Frame, but with smaller diameter hanger.



2511

2511 Series Pocket Door Frame Prices

Item No.	Max Door Size	lbs/Case
Frames for 80" Tall Doors up to 80 lbs.		
25112668	For Doors up to 30" wide x 80" tall x 1 3/8"	27/1
25113068	For Doors up to 36" wide x 80" tall x 1 3/8"	29/1
Frames for 80" Tall Doors up to 150 lbs. (Uses 1025 Ball Bearing Hanger)		
25HD2668	For Doors up to 30" wide x 80" tall x 1 3/8"	27/1
25HD3068	For Doors up to 36" wide x 80" tall x 1 3/8"	29/1
Accessories		
2511PPK3	Hardware Replacement Set (80 lbs.)	4/10
1555PPK3	Converging Door Kit	6/10
1575PPK3	1-3/4" Door Adapter Kit	4/10
1025PLB2	Pair of Hangers for 150 lbs. Doors	4/10

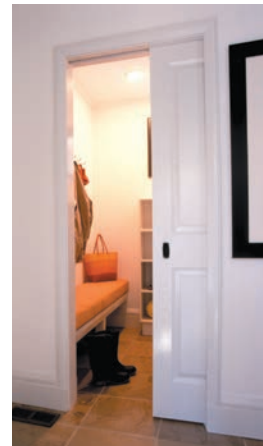

1510 (Finger-Jointed, Primed/For Painting)
1511 (Clear Pine/For Staining)

Universal Pocket Door Jamb Kit
 For 4⁹/₁₆" Thick Walls



ORDERING DATA

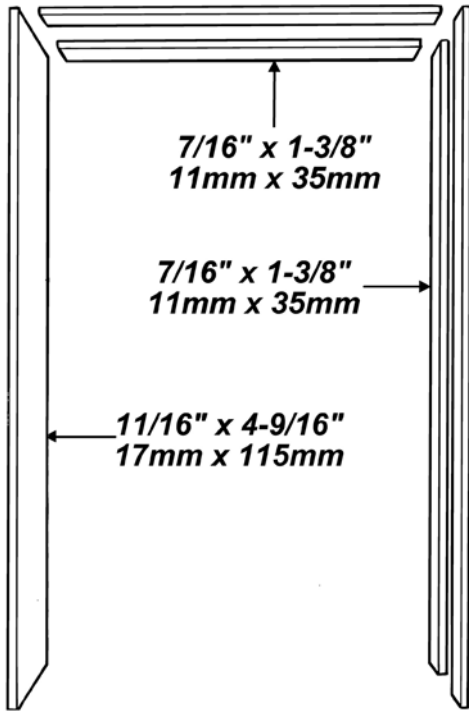

Item No.	Max Door Size	LBS/Case
15103068	3'0" x 6'8"	20/3
15113068	3'0" x 6'8"	20/3

A fast, convenient method of finishing a Pocket Door Installation. Just cut to length and install. No ripping of special thickness stock. Presanded so finishing is a snap.

Package includes 5 boards. Two split header boards, two split jamb boards, and a strike jamb board. (Since a wide variety of casings are available, they are not included)

Jamb can be cut down for smaller sized doors.

Cannot be used with the 2000 Series Frame..



1510/1511

1521 (For 1³/₈" Doors Only)
1534 (For 1³/₄" Doors Only)

Pocket Door Privacy Locks



ORDERING DATA

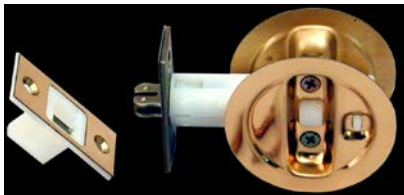

1521/1534



For Converging Doors Use One Privacy Lock, One Dummy Pull, and Two Edge Pulls

Item No.	Description	Color	Door Thickness	LBS/Case
15213PK1	Privacy Lock	US3/Brt. Brass	1 ³ / ₈ "	2.5/5
152115P1	Privacy Lock	US15/Sat. Nic.	1 ³ / ₈ "	2.5/5
15215PK1	Privacy Lock	US5/Ant. Brass	1 ³ / ₈ "	2.5/5
21-3PPK2	Dummy Pull	US3/Brt. Brass	1 ³ / ₈ "	2.6/10
21-15PK2	Dummy Pull	US15/Sat. Nic.	1 ³ / ₈ "	2.6/10
21-5PPK2	Dummy Pull	US5/Ant. Brass	1 ³ / ₈ "	2.6/10
1534-3P1	Privacy Lock	US3/Brt. Brass	1 ³ / ₄ "	1/1
153415P1	Privacy Lock	US15/Sat. Nic.	1 ³ / ₄ "	1/1
1534-5P1	Privacy Lock	US5/Ant. Brass	1 ³ / ₄ "	1/1
134US3	Dummy Pull	US3/Brt. Brass	1 ³ / ₄ "	3/10
134US15	Dummy Pull	US15/Sat. Nic.	1 ³ / ₄ "	3/10
134US5	Dummy Pull	US5/Ant. Brass	1 ³ / ₄ "	3/10
150-3PK1	Edge Pull	US3/Brt. Brass	Universal	2/10
150US15	Edge Pull	US15/Sat. Nic.	Universal	4/25

Bulk 25/Carton

21-PPK/134 "Suncrest" Dummy Pull

US3-Bright Brass

US15-Satin Nickel

US5-Antique Brass

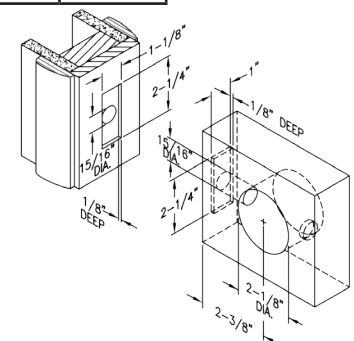

200PD Commercial Grade Pocket Door Hardware for a 1 1/8" or Thicker Door to 300 lbs.



ORDERING DATA

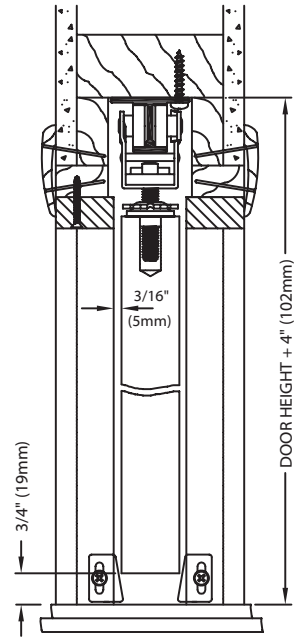
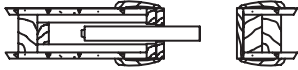

200PD

Item No.	Max Door Size	Lbs./Case
200481DR	One 2'0" Door	Bulk Only
200601DR	One 2'6" Door	5/Case
200721DR	One 3'0" Door	7/1
200961DR	One 4'0" Door	9/1

200PD Components

Qty	Part #
1	200 Track
2	2020 Hangers
1	1550 Guides
1	1513 Bumper

Bulk 5/Case

A deluxe commercial grade hardware set. Can be used for pocket doors or in combination with itself to make special installations of sliding doors. Heavy duty I-beam aluminum track. Four wheel (1" dia.) ball bearing hangers. Brass-tone steel parts. Tracks can be cut down for smaller applications.

200PD Hardware Set



100PD Commercial Grade Pocket Door Hardware for a 1" or Thicker Door to 125 lbs. (200 lbs. with 1125 Hangers)



ORDERING DATA

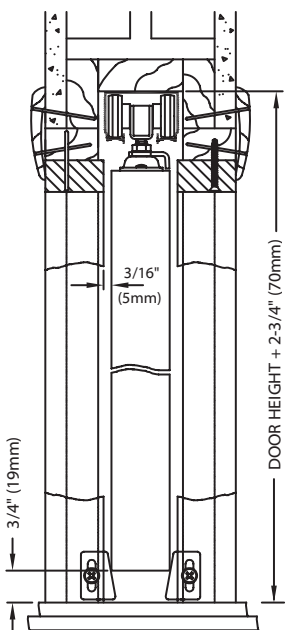

100PD

Item No.	Max Door Size	Lbs./Case
100481DR	One 2'0" Door	12/5
100601DR	One 2'6" Door	14/5
100721DR	One 3'0" Door	16/5
100961DR	One 4'0" Door	20/5

100PD Components

Qty	Part #
1	100 Track
2	1120 Hangers
1	1550 Guides
1	1513 Bumper
1	1712 Wrench

Bulk 25/Case

100PD Hardware Set

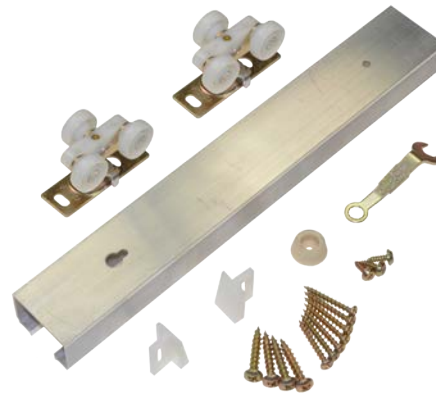

Can be used for pocket doors or in combination with itself to make special installations of sliding doors. Aluminum track with convex rails, jump proof three wheel (1" dia.) hangers assure a smooth, quiet operation. Brass-tone steel parts. Tracks can be cut down for smaller applications.

Optional Hanger #1125 available for doors up to 200 lbs. (Bulk Only)



111PD Commercial Grade Pocket Door Hardware

for a 3/4" or Thicker Door to 80 lbs. (150 lbs. with 1025 Hangers)



ORDERING DATA

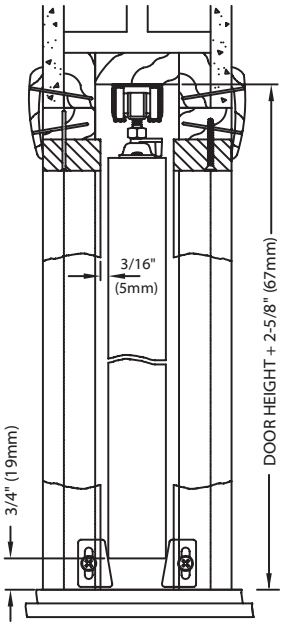
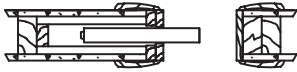

Item No.	Max Door Size	Lbs./Case
111481DR	One 2'0" Door	8/5
111601DR	One 2'6" Door	9/5
111721DR	One 3'0" Door	10/5
111961DR	One 4'0" Door	12/5

111PD Components

Qty	Part #
1	111 Track
2	1020 Hangers
1	1550 Guides
1	1513 Bumper
1	1712 Wrench

Bulk 25/Case

111PD Hardware Set

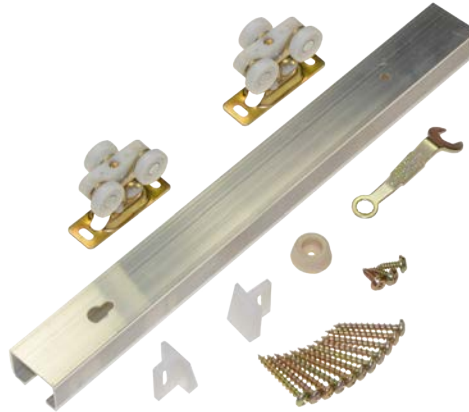

Can be used for pocket doors or in combination with itself to make special installations of sliding doors. Aluminum track with convex rails, jump proof three wheel (3/8" dia.) hangers assure a smooth, quiet operation. Brass-tone steel parts. Tracks can be cut down for smaller applications. *Optional Hanger #1025 available for doors up to 150 lbs. (Bulk Only).*



111PD

2800F Double Fascia Open Pocket Door Hardware

for a 3/4" to 1 3/4" Thick Door to 75 lbs.



ORDERING DATA

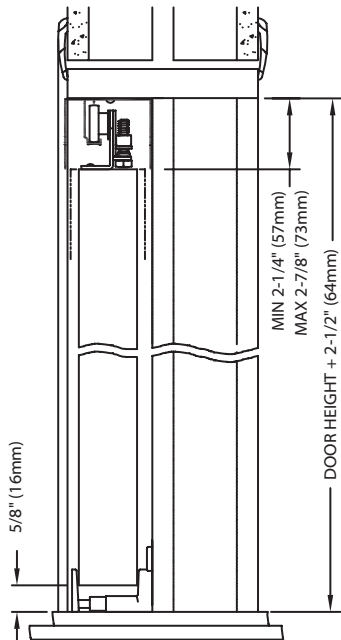

Item No.	Max Door Size	Lbs./Case
2800F481	One 2'0" Door	Bulk Only-20/Case
2800F601	One 2'6" Door	Bulk Only-20/Case
2800F721	One 3'0" Door	20/5
2800F961	One 4'0" Door	25/5

2800F Components

Bulk 20/Case

Qty	Part #
1	2800F Track
2	2815 Hangers
1	12 Guide
1	1513 Bumper
1	1712 Wrench

2800F Hardware Set

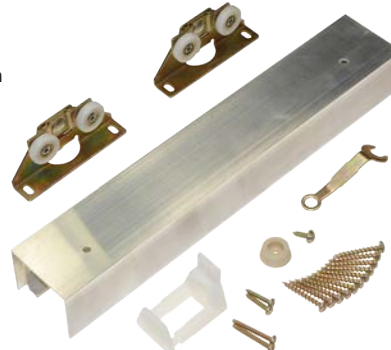

Space saving, header mounted "Open Pocket Door" hardware set. Aluminum double fascia track with a single convex rail, twin wheel (7/8" dia.) ball bearing hangers, wall mount guide. Brass-tone steel parts.



2800F



ORDERING DATA

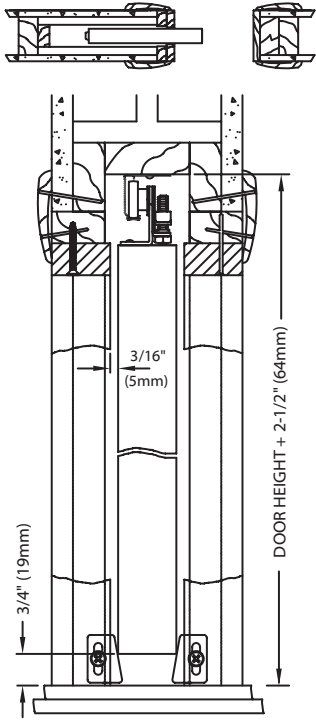

2800/2850

Item No.	Max Door Size	Lbs./Case
2800481D	One 2'0" Door	Bulk Only-25/Case
2800601D	One 2'6" Door	Bulk Only-25/Case
2800721D	One 3'0" Door	9/5
2800961D	One 4'0" Door	11/5
2850481D	One 2'0" Door	Bulk Only-25/Case
2850601D	One 2'6" Door	Bulk Only-25/Case
2850721D	One 3'0" Door	11/5
2850961D	One 4'0" Door	14/5

2800/2850 Components

Qty	Part #
1	2800/2850 Track
2	2802 Hangers
1	1550 Guides
1	1513 Bumper
1	1712 Wrench

Bulk 20/Case

An economical track and hardware set with a single convex rail, which provides one point contact between wheel and track. One wheel (7/8" dia.) hanger. Brass-tone steel parts. 2800 Series offers an upgraded aluminum track. 2850 Series offers an entry-level steel track.

2800 Hardware Set

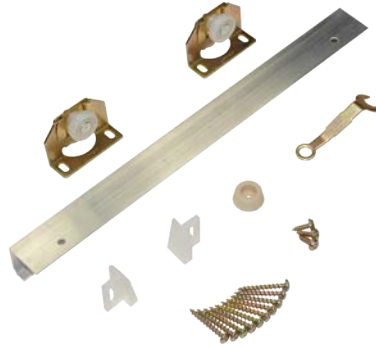

2850 Hardware Set



9000 Closet Rod System



ORDERING DATA

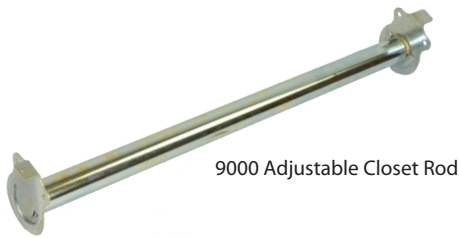

9000 Adjustable Closet Rod



9003 Shelf/Rod Support



9005 Shelf/Rod Support



9030 1 3/8" Pole End Brackets



9027 1 3/8" Rod



9028 1" Rod



9500-096 Valet Rod

Item No.	Size	Lbs./Case
9018-30P	18"-30"	11/10
9030-48P	30"-48"	18/10
9048-72P	48"-72"	24/10
9072-96P	72"-96"	30/10
9072120P	72"-120"	38/10
9096144P	96"-144"	23/5
9003WHEN	----	17/20
9005WHEN	----	11/20
9027PLBG	----	4.5/20
9028PLBG	----	4.1/20
9030PLBG	----	4/100
9500-096	96"	32/20

Bulk 15/Case

22 gauge welded seam tubing plated bright zinc. Rods "Snap" into end bracket, heavy 12 gauge white powder coated shelf and rod supports.

200SD Heavy Duty Bypass Track and Hardware for 1 1/8" or Thicker Doors to 300 lbs.



ORDERING DATA

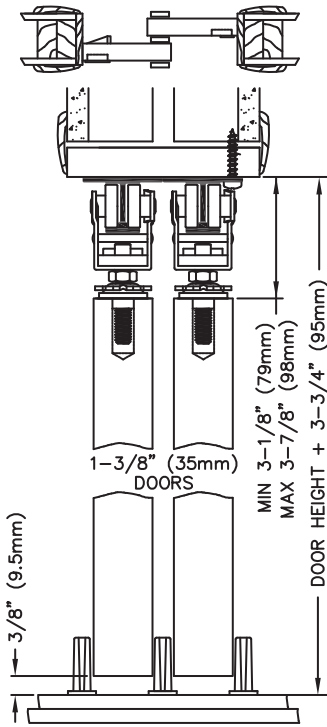

200SD

Item No.	Opening Size	Lbs./Case
200482DR	48"-2 Door	Bulk Only-5/Case
200602DR	96"-2 Door	Bulk Only-5/Case
200722DR	72"-2 Door	14/1
200962DR	96"-2 Door	17/1
2001443DR	144"-3 Door	Bulk Only-5/Case

200SD 2 DR Components

Qty	Part #
2	200 Track
4	2020 Hangers
3	2031 Guides
1	2155 Door Stop
2	30US3 Pull

200SD 3 DR Components

Qty	Part #
2	200 Track
6	2020 Hangers
6	2031 Guides
1	2155 Door Stop
3	30US3 Pull
1	2055 Stop
1	1712 Wrench

A deluxe commercial grade hardware set. Heavy duty extruded aluminum I-beam track. Four wheel ball bearing hangers with machine turned 1" wheels. Heavy duty guide with steel reinforced nylon posts. Brass-tone steel parts. Tracks can be spaced out to accommodate non-standard door thicknesses greater than 1-1/8". Tracks can be cut down for smaller openings.



200SD 2 DR Hardware Set



100SD Heavy Duty Bypass Track and Hardware for 1" or Thicker Doors to 200 lbs.



ORDERING DATA

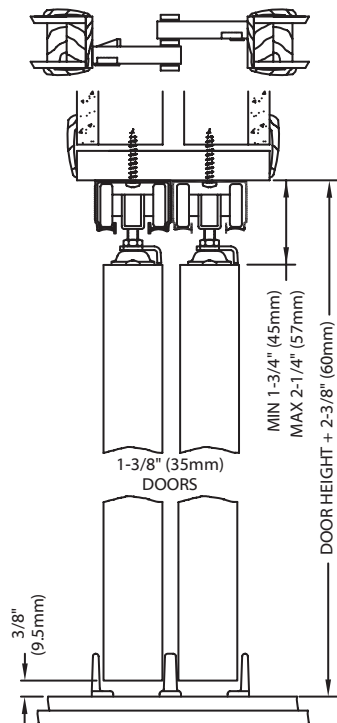

100SD

Item No.	Opening Size	Lbs./Case
100482DR	48"-2 Door	4.5/1
100602DR	60"-2 Door	5.3/1
100722DR	72"-2 Door	6/1
100962DR	96"-2 Door	7.7/1

Bulk 10/Carton

100SD 2 Door Components

Qty	Part #
2	100 Track
4	1125 Hangers
1	101 Guide Set
1	2155 Door Stop
2	30US3 Pull
1	1712 Wrench

A commercial grade bypass sliding door hardware set for doors weighing up to 200 pounds each. Heavy-duty extruded aluminum box track utilizes three-wheeled ball-bearing rollers (#1125) with 1" diameter machine turned wheels. The three piece guide is adjustable for different thicknesses of doors. (minimum door thickness is 1")



100SD Hardware Set



111SD Heavy Duty Bypass Track and Hardware for 3/4" or Thicker Doors to 150 lbs.



ORDERING DATA

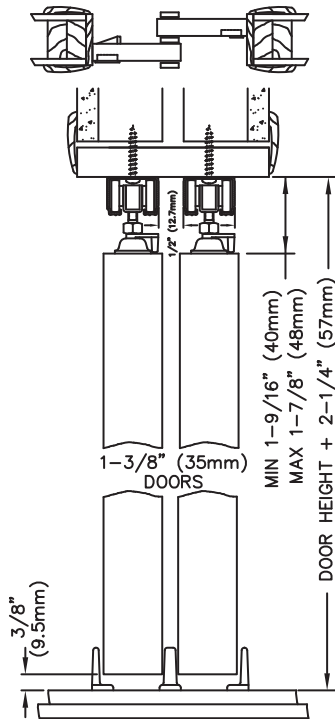

111SD

Item No.	Opening Size	Lbs./Case
111482DR	48"-2 Door	4.7/1
111602DR	60"-2 Door	5.2/1
111722DR	72"-2 Door	5.7/1
111962DR	96"-2 Door	6.9/1

Bulk 10/Case

111SD 2 Door Components

Qty	Part #
2	111 Track
4	1025 Hangers
1	101 Guide Set
1	2155 Door Stop
2	30US3 Pull
1	1712 Wrench

A commercial grade bypass sliding door hardware set for doors weighing up to 150 pounds each. Heavy-duty extruded aluminum box track utilizes three-wheeled ball-bearing rollers (#1025) with 3/4" diameter machine turned wheels. The three piece guide is adjustable for different thicknesses of doors. (minimum door thickness is 3/4")



111SD Hardware Set



134F Heavy Duty Bypass Track and Hardware for 1 3/4" Doors to 125 lbs. (200 lbs. with 1125 Ball Bearing Hanger)



ORDERING DATA

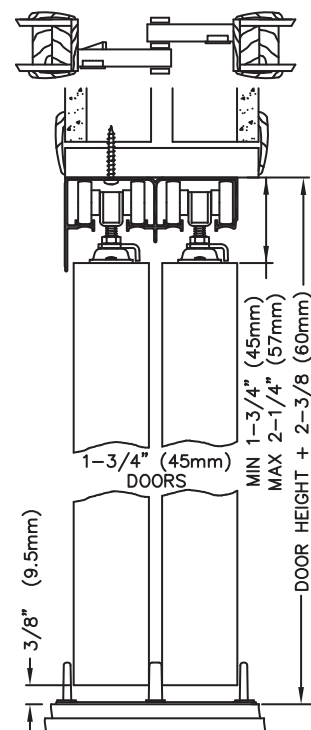

134F

Item No.	Opening Size	Lbs./Case
134F482D	48"-2 Door	24/5
134F602D	60"-2 Door	29/5
134F722D	72"-2 Door	33/5
134F964D	96"-4 Door	30/3

Bulk 10/Case

134F 2 Door Components

Qty	Part #
1	134F Track
4	1120 Hangers
1	2134 Guide Set
1	2155 Door Stop
2	30US3 Pull
1	1712 Wrench

134F 4 Door Components

Qty	Part #
1	134F Track
8	1120 Hangers
2	2134 Guide Set
2	2155 Door Stop
4	30US3 Pull
1	1712 Wrench
2	1155 Stop

Commercial grade track (for 1 3/4" thick doors) with an aluminum fascia which hides hangers from view. Three wheel (1" dia.) hangers ride on convex rails for a smooth, quiet operation. Door guide is woodtone with pivot action that align guide posts with door. Brass-tone, steel parts.

*Optional hanger #1125 available for doors to 200 lbs./each. (Bulk Only).

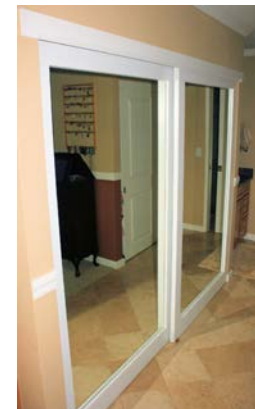

134F Hardware Set



138F Heavy Duty Bypass Track and Hardware for 1 3/8" Doors to 125 lbs. (200 lbs. with 1125 Ball Bearing Hanger)



ORDERING DATA

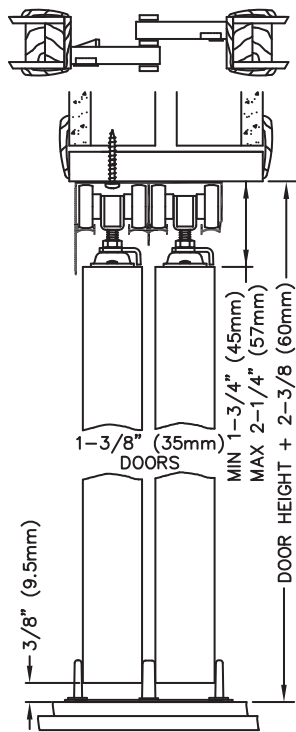

138F

Item No.	Opening Size	Lbs./Case
138F482D	48"-2 Door	22/5
138F602D	60"-2 Door	26/5
138F722D	72"-2 Door	30/5
138F964D	96"-4 Door	26/3

Bulk 10/Case

138F 2 Door Components

Qty	Part #
1	138F Track
4	1120 Hangers
1	2135 Guide Set
1	2155 Door Stop
2	30US3 Pull
1	1712 Wrench

138F 4 Door Components

Qty	Part #
1	138F Track
8	1120 Hangers
2	2135 Guide Set
2	2155 Door Stop
4	30US3 Pull
1	1712 Wrench
2	1155 Stop

Commercial grade track (for 1 3/8" thick doors) with an aluminum fascia which hides hangers from view. Three wheel (1" dia.) hangers ride on convex rails for a smooth, quiet operation. Door guide is woodtone with pivot action that align guide posts with door. Brass-tone, steel parts.

Optional hanger #1125 available for doors to 200 lbs./each. (Bulk Only).



138F Hardware Set



118F Heavy Duty Bypass Track and Hardware for 1 1/8" Doors to 80 lbs. (150 lbs. with 1025 Ball Bearing Hanger)



ORDERING DATA

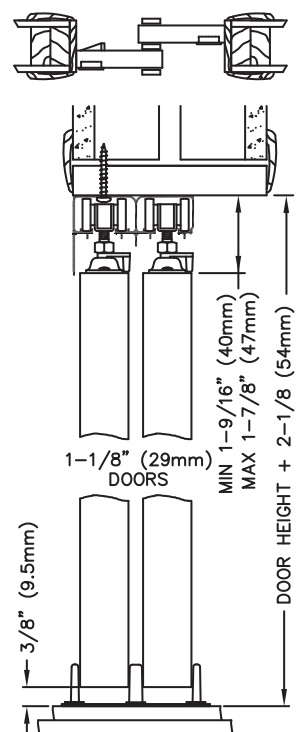

118F

Item No.	Opening Size	Lbs./Case
118F482D	48"-2 Door	17/5
118F602D	60"-2 Door	21/5
118F722D	72"-2 Door	24/5
118F964D	96"-4 Door	34/5

Bulk 10/Case

118F 2 Door Components

Qty	Part #
1	118F Track
4	1020 Hangers
1	2118 Guide Set
1	2155 Door Stop
2	30US3 Pull
1	1712 Wrench

118F 4 Door Components

Qty	Part #
1	118F Track
8	1020 Hangers
2	2118 Guide Set
2	2155 Door Stop
4	30US3 Pull
1	1712 Wrench
2	1155 Stop

Commercial grade track (for 1 1/8" thick doors) with an aluminum fascia which hides hangers from view. Three wheel (3/4" dia.) hangers ride on convex rails for a smooth, quiet operation. Door guide is woodtone with pivot action that align guide posts with door. Brass-tone, steel parts.

**Optional hanger #1025 available for doors to 150 lbs./each. (Bulk Only).*



118F Hardware Set



2200F Residential Grade Bypass Fascia Track and Hardware for 1 3/8" Doors to 50 lbs. (One Wheel) or 75 lbs. (Two Wheel)



ORDERING DATA

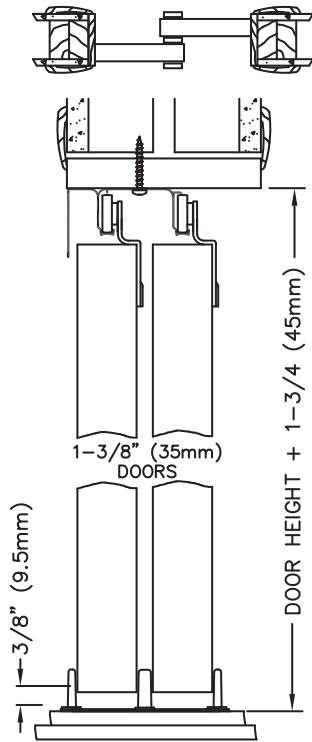

2200F

Item No.	Opening Size	Lbs./Case
2200F481	48"-2 Door	13/5
2200F601	60"-2 Door	15/5
2200F721	72"-2 Door	16/5
2200F961	96"-4 Door	26/5
*2200F482	48"-2 Door	14/5
*2200F602	60"-2 Door	16/5
*2200F722	72"-2 Door	18/5
*2200F962	96"-4 Door	27/5

Bulk 25/Cartron

2200F 2 Door Components

Qty	Part #
1	2200F Track
4	2238 Hangers (2228 2 Whl)
1	2135 Guide Set
2	15US3 Pull

2200F 4 Door Components

Qty	Part #
1	2200F Track
8	2238 Hangers (2228 2 Whl)
2	2135 Guide Set
1	2255 Stop Kit
4	15US3 Pull

An aluminum fascia track with "Hi-Lite" design to hide blemishes that may occur. Convex track rails that provide one point contact between wheel and track. Hangers include one or two wheels (7/8" dia.) with three point locking. Hangers adjust without removing or relocating screws. Woodtone guide adjusts laterally for quick plumbing. Nylon guide posts are 1" high, guide posts swivel to allow warped doors to operate without binding. Brass-tone steel parts.

* 2 Wheel Hangers for 75 lbs. per door.



2200F Hardware Set



2204F Residential Grade Bypass Fascia Track and Hardware for 3/4" Doors to 50 lbs.



ORDERING DATA

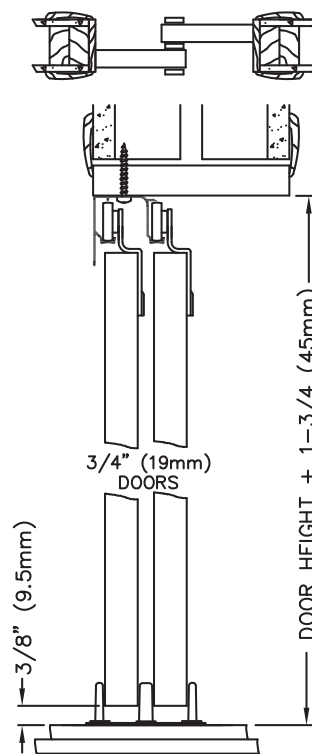

2204F

Item No.	Opening Size	Lbs./Case
2204F481	48"-2 Door	
2204F601	60"-2 Door	
2204F721	72"-2 Door	15/5
2204F961	96"-4 Door	22/5

Bulk 20/Cartron

2204F 2 Door Components

Qty	Part #
1	2204F Track
4	2238 Hangers (2228 2 Whl)
1	2175 Guide
2	15US3 Pull

2204F 4 Door Components

Qty	Part #
1	2204F Track
8	2238 Hangers (2228 2 Whl)
2	2175 Guide Set
1	2255 Stop Kit
4	15US3 Pull

A premium, residential bypass set for 3/4" thick doors. Uses an aluminum fascia track with "Hi-Lite" design to hide blemishes that may occur. Convex track rails that provide one point contact between wheel and track. Hangers include one or two wheels (7/8" dia.) with three point locking. Hangers adjust without removing or relocating screws. Woodtone guide adjusts laterally for quick plumbing. Nylon guide posts are 1" high, guide posts swivel to allow warped doors to operate without binding. Brass-tone steel parts.



2204F Hardware Set

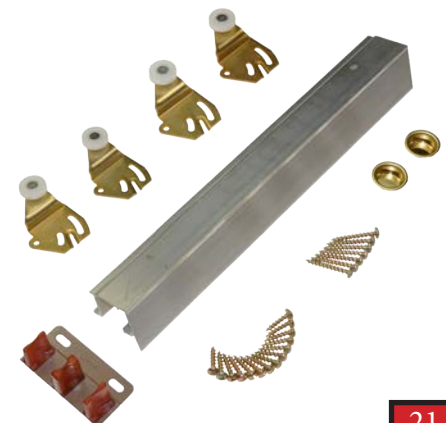

2222 Residential Grade Bypass Track and Hardware with Wood Header for 1 3/8" Doors to 50 lbs. (One Wheel) or 75 lbs. (Two Wheels)



ORDERING DATA

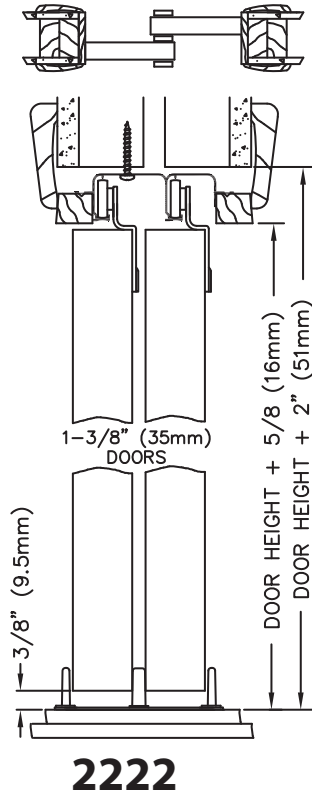

Item No.	Opening Size	Lbs./Case
22224814	48"-2 Door	
22226014	60"-2 Door	
22227214	72"-2 Door	Bulk
22229614	96"-4 Door	Only
*22224824	48"-2 Door	10/Case
*22226024	60"-2 Door	
*22227224	72"-2 Door	
*22229624	96"-4 Door	

2222 2 Door Components

Qty	Part #
1	2222 Track
4	2238 Hangers (2228 2 Whl)
1	2135 Guide Set
2	15US3 Pull

2222 4 Door Components

Qty	Part #
1	2222 Track
8	2238 Hangers (2228 2 Whl)
2	2135 Guide Set
1	2255 Stop Kit
4	15US3 Pull

Prefabricated header with aluminum track replaces the regular head jamb. Keeps the bypass doors the same trim height as swinging doors. Eliminates odd door heights. Convex track rails, 7/8" dia. wheels, adjustable hangers, adjustable guide. Brass-tone steel parts. Also available for 5/4" jamb and without wood. Contact factory.

* 2 Wheel Hangers for 75 lbs. per door.



2222 Hardware Set

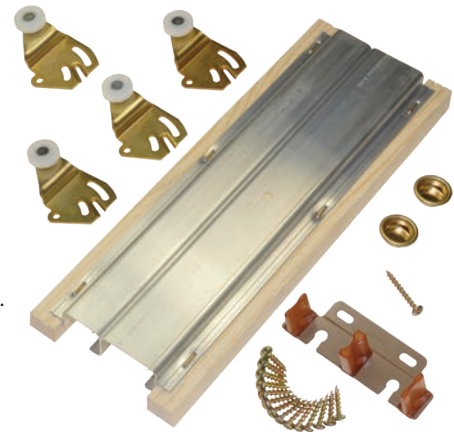

2200 Bypass Track and Hardware for 3/4" or 1 3/8" Doors to 50 lbs.



ORDERING DATA

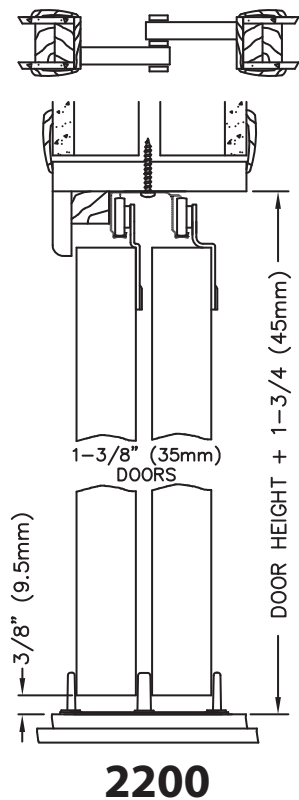

Item No.	Opening Size	Lbs./Case
2200482D	48"-2 Door	10/5
2200602D	60"-2 Door	12/5
2200722D	72"-2 Door	13/5
2200964D	96"-4 Door	19/5

Bulk 25/Case

2200 2 Door Components

Qty	Part #
1	2200 Track
2	2216 Hangers
2	2238 Hangers
1	2135 Guide
2	15US15 Pulls

2200 4 Door Components

Qty	Part #
1	2200 Track
4	2216 Hangers
4	2238 Hangers
2	2135 Guides
4	15US15 Pulls
1	2255 Stop Kit

Aluminum bypass track with convex track rails for quiet, smooth operation. One wheel (7/8" dia.) hangers with three point locking provide one point contact between wheel and track. One inch high woodtone adjustable door guide. Brass-tone steel parts.



2200 Hardware Set

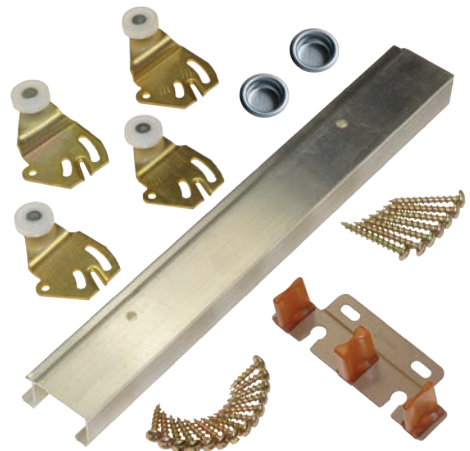

1166 Bypass Track and Hardware

for 3/4" or 1 3/8" Doors to 50 lbs.



ORDERING DATA

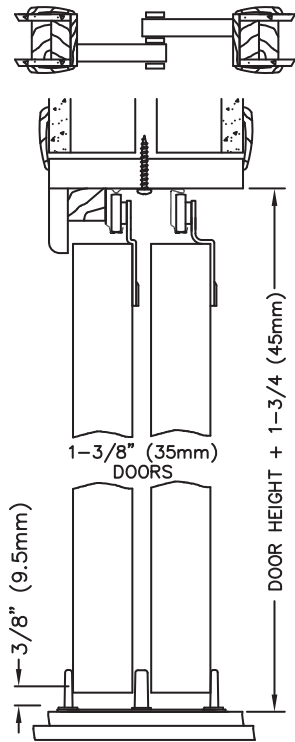

1166

Item No.	Opening Size	Lbs./Case
1166G482	48"-2 Door	13/5
1166G602	60"-2 Door	16/5
1166G722	72"-2 Door	18/5
1166G964	96"-4 Door	26/5

Bulk 25/Case

1166 2 Door Components

Qty	Part #
1	1166 Track
2	2216 Hangers
2	2238 Hangers
1	2135 Guide
2	15US15 Pulls

1166 4 Door Components

Qty	Part #
1	1166 Track
4	2216 Hangers
4	2238 Hangers
2	2135 Guides
4	15US15 Pulls
1	2255 Stop Kit

An economical prefinished gold colored steel bypass track with convex track rails, which provide one point contact between wheel and track. One wheel (7/8" dia.) hangers with three point locking. One inch high woodtone adjustable door guide. Brass-tone steel parts.



1166 Hardware Set

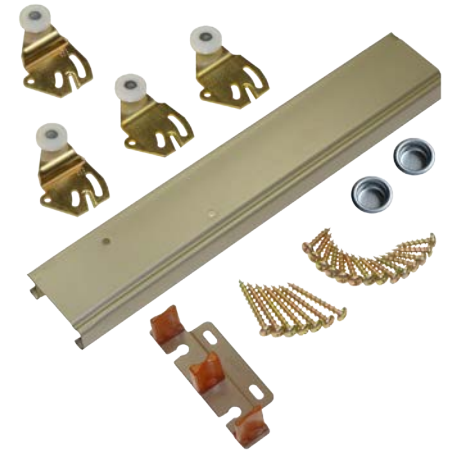

1138 Bypass Track and Hardware

For 1 3/8" Doors to 50 lbs.



ORDERING DATA

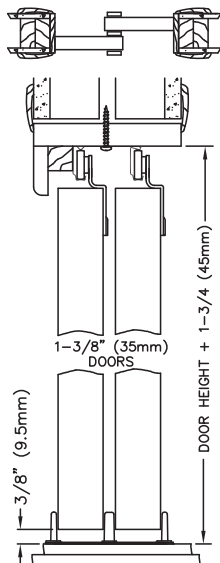

1138

1138 2 Dr Components

Qty	Part #
1	1138 Track
4	2238 Hangers
1	2135 Guide
2	15US3 Pulls



1138 4 Dr Components

Qty	Part #
1	1138 Track
8	2238 Hangers
2	2135 Guide
4	15US3 Pulls
1	2255 Stop Kit



An economical prefinished gold colored steel bypass track with convex track rails, which provide one point contact between wheel and track. One wheel (7/8" dia.) hangers with three point locking. One inch high woodtone adjustable door guide. Brass-tone steel parts.

Item No.	Opening Size	Lbs./Case
1138482D	48"-2 Door	13/5
1138602D	60"-2 Door	16/5
1138722D	72"-2 Door	19/5
1138964D	96"-4 Door	27/5

Bulk 20/Case

113F Bypass Fascia Track and Hardware

For 1 3/8" Doors to 50 lbs.



ORDERING DATA

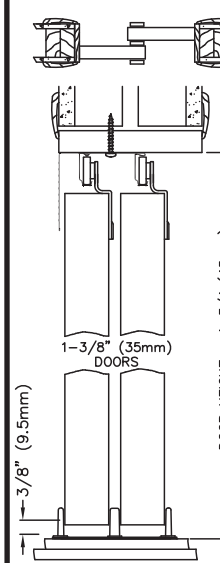

113F

113F 2 Dr Components

Qty	Part #
1	1138 Track
1	126F Fascia
4	2238 Hangers
1	2135 Guide
2	15US3 Pulls



113F 4 Dr Components

Qty	Part #
1	1138 Track
1	126F Fascia
8	2238 Hangers
2	2135 Guide
4	15US3 Pulls
1	2255 Stop Kit



An economical prefinished gold colored steel bypass track with a "Snap-on Fascia". Convex track rails, which provide one point contact between wheel and track. One wheel (7/8" dia.) hangers with three point locking. One inch high woodtone adjustable door guide. Brass-tone steel parts.

Item No.	Opening Size	Lbs./Case
113FG481	48"-2 Door	19/5
113FG601	60"-2 Door	23/5
113FG721	72"-2 Door	27/5
113FG961	96"-4 Door	27/5

Bulk 20/Case

Multiple-Door Sliding Door Hardware

200MD, 100MD, 111MD



Shown below are typical 3 track layouts for 1-3/8" doors. Other door thicknesses may be used. For thicker doors, the tracks must be spaced further apart and a wider header may be necessary. Also, more than 3 tracks may be used by extending the header and using other track combinations as required.



200MD Series-300 lbs. Doors

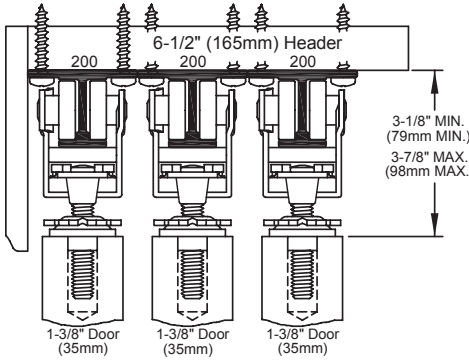

100MD Series-200 lbs. Doors

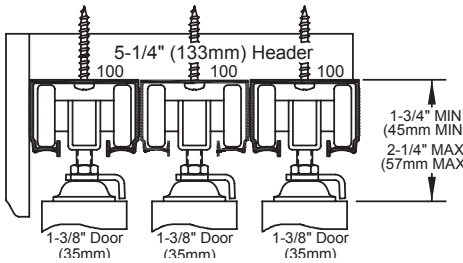

111MD Series-150 lbs. Doors

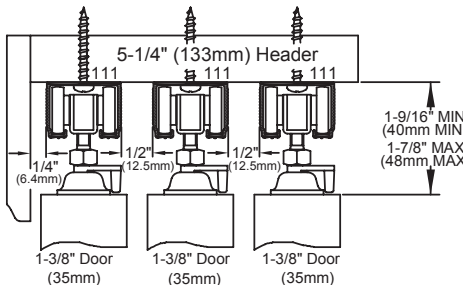

1050 Bottom Track- Included w/ all Sets

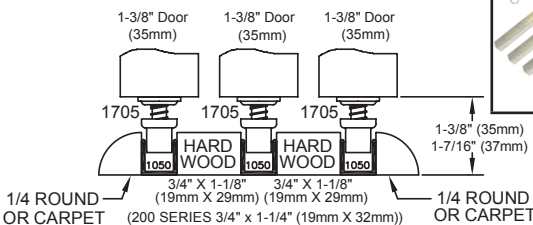

All nosing and hardware filler supplied by others. Surface mount shown/ Bottom channel may be recessed into floor. Spacing and dimensions will vary with other door thicknesses.

Tracks can be cut down for smaller openings.

6', 8', and 9' Sets Utilizing 200, 100, and 111 Hardware Sets.

200MD Series Hardware Sets- 300lbs Doors (min 1-1/8" thick)				
Set Image	Part #	Track Length	Max Door Width (ea)	Max Door Weight (ea)
	200M0723	70" 1829mm	24" x 3 610mm x 3	300 lbs. 136 kgs.
	200M0963	94" 2438mm	32" x 3 813mm x 3	300 lbs. 136 kgs.
	200M1083	106" 2692mm	36" x 3 914mm x 3	300 lbs. 136 kgs.
	200M1443	142" 3657mm	48" x 3 1219mm x 3	300 lbs. 136 kgs.
Set consists of 3-200 tracks, 3-1050 bottom tracks, 6-2020 hangers, 6-1705 guides, and 2-2055 track stops.				

100MD Series Hardware Sets- 200lbs Doors (min 1" thick)				
Set Image	Part #	Track Length	Max Door Width (ea)	Max Door Weight (ea)
	100M0723	70" 1829mm	24" x 3 610mm x 3	200 lbs. 91 kg.
	100M0963	94" 2438mm	32" x 3 813mm x 3	200 lbs. 91 kg.
	100M1083	106" 2692mm	36" x 3 914mm x 3	200 lbs. 91 kg.
	100M1443	142" 3657mm	36" x 3 1219mm x 3	200 lbs. 91 kg.
Set consists of 3-100 tracks, 3-1050 bottom tracks, 6-1125 hangers, 6-1705 guides, and 2-1155 track stops.				

111MD Series Hardware Sets- 150lbs Doors (min 3/4" thick)				
Set Image	Part #	Track Length	Max Door Width (ea)	Max Door Weight (ea)
	111M0723	70" 1829mm	24" x 3 610mm x 3	150 lbs. 68 kgs.
	111M0963	94" 2438mm	32" x 3 813mm x 3	150 lbs. 68 kgs.
	111M1083	106" 2692mm	36" x 3 914mm x 3	150 lbs. 68 kgs.
	111M1443	142" 3657mm	48" x 3 1219mm x 3	150 lbs. 68 kgs.
Set consists of 3-111 tracks, 3-1050 bottom tracks, 6-1025 hangers, 6-1705 guides, and 2-1155 track stops.				



2054 PLBG
MULTI PULL CATCH

2054PLBG

Multi Pull Catch

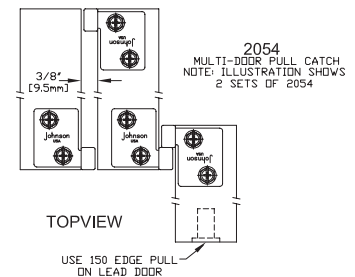



Item No.	Length	Pkg/Qty	Wt/Ctn
100721DD	72"	25/Ctn	75 lbs.

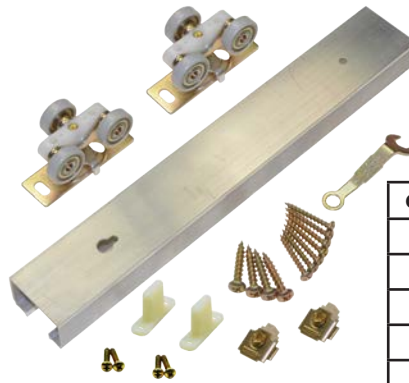

NO MORE WRESTLING WITH LOOSE PANELS OR DOORS!

Display your doors with easy-to-construct sliding "show walls". These displays take up less floor space than the old methods of stacking or leaning doors.

The **Door Panel Display** uses the same track and hanger system as the Johnson 1500 Pocket Door Frame and can handle 3'0" doors up to 200 lbs..

Qty	Part #
1	100-0072
2	1125 Hangers
2	10 Guide
1	1712 Wrench
2	1155 Stops



TABLE LEGS AND PANTRY SLIDE

8800 Folding Table Leg



Item No.	Length	Pkg/Qty	Wt/Ctn
88265-WT	26½"	20/Ctn	28 lbs.
88275-WT	27½"	20/Ctn	28 lbs.
88285-WT	28½"	20/Ctn	29 lbs.
88295-WT	29½"	20/Ctn	29 lbs.
88305-WT	30½"	20/Ctn	30 lbs.

88ADJ-WT Adjustable Table Leg

Adjustable in 1" intervals

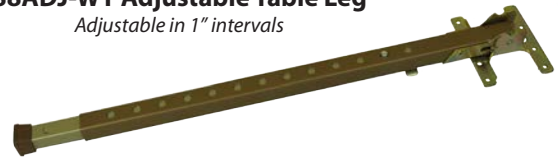

Item No.	Length	Pkg/Qty	Wt/Ctn
88ADJ-WT	19½"-31½"	20/Ctn	29 lbs.

88TEL-WT Telescoping Table Leg

Adjustable in ½" intervals



Item No.	Length	Pkg/Qty	Wt/Ctn
88TEL-WT	26"-31½"	20/Ctn	29 lbs.

7800 Folding Gaucho Leg



Item No.	Length	Pkg/Qty	Wt/Ctn
78245-WT	24½"	20/Ctn	23 lbs.
78255-WT	25½"	20/Ctn	24 lbs.
78265-WT	26½"	20/Ctn	25 lbs.
78275-WT	27½"	20/Ctn	26 lbs.
78285-WT	28½"	20/Ctn	26 lbs.
78295-WT	29½"	20/Ctn	27 lbs.
78305-WT	30½"	20/Ctn	28 lbs.

7700 Fixed Length Gaucho Leg

Custom lengths from 6" to 24" at ½" intervals



Item No.	Length	Pkg/Qty
7700	6"-12"	40/Ctn
7700	12½"-18"	20/Ctn
7700	18½"	20/Ctn

955022PS Pantry Slide

*Standard length 22", opens to 38"
Can be ordered to custom lengths*

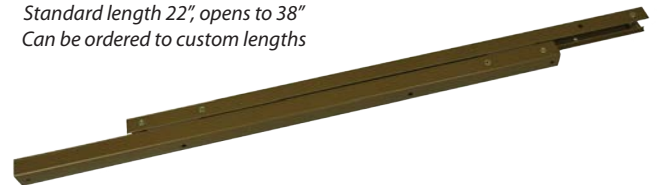

Item No.	Length	Pkg/Qty	Wt/Ctn
955022PS	22"-38"	10/Ctn	15 lbs.

<p>100 Series Aluminum 25/case</p>	<p>1138 Series Steel 20/case</p>	<p>2204F Series Aluminum 25/case</p>
<p>111 Series Aluminum 25/case</p>	<p>1166 Series Steel 25/case</p>	<p>2222 Series Aluminum</p> <p>with 4 9/16" wood 10/case without wood 25/case</p>
<p>118F Series Aluminum 10/case</p>	<p>126F Fascia Steel 20/case Goldtone Woodtone</p>	<p>2610F Series Aluminum 10/case</p>
<p>134F Series Aluminum 10/case</p>	<p>1700 Series Steel 25/case Brown White</p>	<p>2610FB Series Aluminum Ant. Bronze 10/case</p>
<p>138F Series Aluminum 10/case</p>	<p>1825/1838 Steel 25/case Brown White</p>	<p>2800 Series Aluminum 25/case</p>
<p>170A Series Aluminum 20/case</p>	<p>1855 Threshold Steel 25/case Woodtone White</p>	<p>2800F Series Aluminum 20/case</p>
<p>200 Series Aluminum 5/case</p>	<p>2200 Series Aluminum 25/case</p>	<p>2850 Series Steel 25/case Goldtone</p>
<p>1050 Bot. Chan. Aluminum 6/case</p>	<p>2200F Series Aluminum 25/case</p>	<p>Drawings not to scale</p>
<p>26</p>		

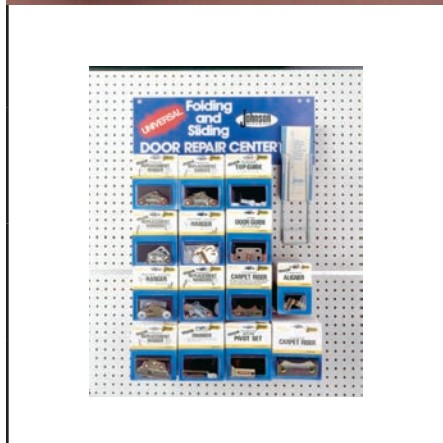











<p>G1738 COMBINATION SLIDING-FOLDING DOOR ASSORTMENT 5-1700363H, 10-1700486H, 5-1700606H, 5-1700726H, 10-1138482D, 5-1138602D, 5-1138722D</p>	G1738
<p>G2200F SLIDING DOOR ASSORTMENT 20-2200F481, 10-2200F601, 10-2200F721</p>	G2200F
<p>G9000 CLOSET ROD AND SHELF SUPPORT ASSORTMENT 10-9018-30P, 20-9030-48P, 10-9048-72P, 5-9072-96P, 5-9072120P, 20-9003WHEN, 20-9005WHEN, 20-9030PPK3</p>	G9000
<p>G40 4' MODULAR COMB. SLIDING-FOLDING-POCKET-REPLACEMENT ASSORTMENT (CONSISTS OF THE FOLLOWING G41 AND G42 2' MODULAR SETS)</p>	G40 G40MINI
<p>G41 2' COMBINATION SLIDING-FOLDING-POCKET ASSORTMENT 5-1166G482, 5-1166G602, 5-1166G722, 5-100721DR, 2-153068PF 5-1700363H, 5-1700486H, 5-1700606H, 5-1700726H</p>	G41 G41MINI
<p>G42 2' ACCESSORY ASSORTMENT 5-1601218P, 5-2216PPK2, 5-2238PPK2, 5-2136PPK1, 5-1836PPK1, 10-2376PPK2, 10-2378PPK2, 10-2336PPK2, 10-2338PPK2, 10-2135PPK1, 10-1832PPK3, 10-1817PPK3, 10-1808PPK1, 5-1555PPK3, 5-15213PK1, 10-150-3PK1, 5-1500PPK3, 5-1700PPK3, 10-1703PPK2, 10-1805PPK2, 10-15-3PPK3, 10-33--PPK2, 10-2155PPK1, 5-1575PPK3, 10-2312PPK1, 10-1833PPK3</p>	G42 G42MINI
<p>G44 (SAME AS G40 EXCEPT W/2200 ALUMINUM TRACK)</p>	G44 G44MINI
<p>G45 (SAME AS G41 EXCEPT W/2200 ALUMINUM TRACK)</p>	G45 G45MINI
<p>G60 6' MODULAR COMB. SLIDING-FOLDING-POCKET-REPLACEMENT ASSORTMENT (CONSISTS OF THE FOLLOWING G61, G62, AND G63 2' MODULAR SETS)</p>	G60 G60MINI
<p>G61 2' COMBINATION SLIDING-FOLDING ASSORTMENT 10-1166G482, 5-1166G602, 5-1166G722, 5-100721DR, 5-1700363H, 10-1700486H, 5-1700606H, 5-1700726H</p>	G61 G61MINI
<p>G62 2' ACCESSORY ASSORTMENT 5-1601218P, 5-2216PPK2, 5-2238PPK2, 5-2136PPK1, 5-1836PPK1, 10-2376PPK2, 10-2378PPK2, 10-2336PPK2, 10-2338PPK2, 10-2135PPK1, 10-1832PPK3, 10-1817PPK3, 10-1808PPK1, 5-1700PPK3, 10-1703PPK2, 10-1805PPK2, 10-15-3PPK3, 10-33--PPK2, 10-2155PPK1, 10-2312PPK1, 10-1833PPK3 10-38-3PPK1, 10-35-3PPK2, 10-30-3PPK2, 10-40-3PPK2, 36--PPK2, 10-1823PPK2</p>	G62 G62MINI
<p>G63 2' POCKET DOOR FRAME AND ACCESSORY ASSORTMENT 4-153068PF, 3-15113068, 10-1555PPK3, 5-15213PK1, 5-21-3PPK2, 10-150-3PK1, 5-1500PPK3, 10-1575PPK3,</p>	G63 G63MINI
<p>G64 (SAME AS G60 EXCEPT W/2200 ALUMINUM TRACK)</p>	G64
<p>G65 (SAME AS G61 EXCEPT W/2200 ALUMINUM TRACK)</p>	G65
<p>MINI1601 FULL ACCESS FOLDING DOOR HARDWARE 10-1601218P SETS AND WORKING DISPLAY MODEL</p>	MINI1601
<p>W10 COMBINATION UNIVERSAL SLIDING/FOLDING REPL PARTS 5-2216PPK2, 5-2238PPK2, 5-2136PPK1, 5-1836PPK1, 10-2376PPK2, 10-2378PPK2, 10-2336PPK2, 10-2338PPK2, 10-2135PPK1, 10-1832PPK3 10-1817PPK3, 10-1808PPK1, 10-2312PPK1, 10-1833PPK3</p>	W10 W10MINI
<p>W11 UNIVERSAL SLIDING DOOR REPLACEMENT PARTS 5-2216PPK2, 5-2238PPK2, 5-2136PPK1, 5-2156PPK3, 5-2155PPK1, 5-2312PPK1 5-15-3PPK3, 10-2376PPK1, 10-2378PPK1, 10-2336PPK1, 10-2338PPK1 10-2135PPK1</p>	W11
<p>W12 UNIVERSAL FOLDING DOOR REPLACEMENT PARTS 5-33--PPK2, 5-1836PPK1, 10-1832PPK3, 10-1817PPK3, 10-1808PPK1, 10-1823PPK2, 10-1703PPK2, 10-1805PPK2, 10-1833PPK3</p>	W12

Mini Assortments include two of each item

BUBBLE PACKED PARTS AND ACCESSORIES















KNOBSPULLS	PART #	Lbs./CT	LIST	KNOBSPULLS	PART #	LBS/CT	LIST
15 3/4" Round Brass Plated Steel Pull 4 per Pack 	15-3PPK3	.6/10	4 per Pack	35 1 3/8" x 3" Plated Steel Pull US3/US5/US15 Bright Brass/Ant. Brass/Sat. Nickel 	35-3PPK2 35-5PPK2 35-15PK2	1.4/10	2 per Pack
20 1 3/4" Round Woodtone Pull Styrene 	20--PLB2	1/10	2 per Pack	36 1 3/4" Dia. Wood(Birch) Knob 	36--PPK2	1.3/10	2 per Pack
21 2 1/8" Plated Steel US3/US5/US15 Dummy Pull Bright Brass/Ant. Brass/Sat. Nickel 	21-3PPK2 21-5PPK2 21-15PK2	2/10	2 per Pack	38 1 1/2" Dia. Bright Brass Knob 	38-3PPK1	1.5/10	1 per Pack
30 2 1/8" Plated Steel US3/US5/US15 Pull Bright Brass/Ant. Brass/Sat. Nickel 	30-3PPK2 30-5PPK2 30-15PK2	1.7/10	2 per Pack	40 1 3/8" x 3" Plated Steel Pull US3/US5/US15 Bright Brass/Ant. Brass/Sat. Nickel 	40-3PPK2 40-5PPK2 40-15PK2	1.4/10	2 per Pack
33 1 3/4" Dia. Woodtone Knob Styrene 	33--PPK2	1.1/10	2 per Pack	150 Die Cast Bright Brass Finish Edge Pull Satin Nickel Avail. in Bulk Only 	150-3PK1	1.3/10	1 per Pack















BUBBLE PACKED PARTS AND ACCESSORIES

















107PIV-S Pivot Set 	5.5/10 1 Set/Pk.	1575PPK3 1 3/4" Adapt Kit 	3/10 1 Set/Pk.	1832PPK3 Univ Pivot 	1.3/10 1 Set/Pk.	2226PPK2 Hanger 1/16" Offset 	3.5/10 2 Ea./Pk.
109PIV-S Pivot Set 	9.1/10 1 Set/Pk.	1606PLB2 Hinge Brown 	3.8/10 2 Ea./Pk.	1833PPK3 Univ Snubber 	.8/10 1 Set/Pk.	2228PPK2 Hanger 3/8" Offset 	3.7/10 2 Ea./Pk.
118PIV-S Pivot Set 	2.2/10 1 Set/Pk.	1700PPK3 Bifold Hdwe 	4.8/10 1 Set/Pk.	1836PPK1 Carpet Riser (FD) 	1.4/10 1 Ea./Pk.	2238PPK2 Hanger 3/8" Offset 	2.6/10 2 Ea./Pk.
119PIV-S Pivot Set 	4/10 1 Set/Pk.	1703PPK2 Hinge 	3.2/10 2 Ea./Pk.	1875PLBG Pivots 	1.4/10 1 Set/Pk.	2255PLB3 4 Dr. Stop Kit 	2/10 1 Set/Pk.
209PIV-S Pivot Set 	1.6/1 1 Set/Pk.	1706PLB3 Pivots 	1.9/10 1 Set/Pk.	2006PLBG Wall Mount Bracket 	2.8/10 1 Ea./Pk.	2312PPK1 Univ. Hngr. 7/8" Whl. 	3/10 1 Ea./Pk.
1120PPK1 Hanger 1" Wheel 	7/10 1 Ea./Pk.	1743PLB2 Hinge 	1.3/10 2 Ea./Pk.	2050PLBG Conv. Door Kit 	10/10 1 Set/Pk.	2336PPK2 Univ. V 1/16" Offset 3/4" Wheel 	2/10 2 Ea./Pk.
1125PPK1 Ball Brg. 1" Wheel 	7/10 1 Ea./Pk.	1805PPK2 Hinge 	2.4/10 2 Ea./Pk.	2135PPK1 Guide 	1.3/10 1 Ea./Pk.	2338PPK2 Univ. V 3/8" Offset 3/4" Wheel 	2/10 2 Ea./Pk.
1500PPK3 1500 Hdwe. Set 	6.0/10 1 Set/Pk.	1806PPK3 Pivot 	1.5/10 1 Set/Pk.	2136PPK1 Carpet Riser (SD) 	1.8/10 1 Ea./Pk.	2376PPK2 Univ. V 1/16" Offset 7/8" Wheel 	2/10 2 Ea./Pk.
1505PPK3 Guide/ Bumper 	.7/10 1 Set/Pk.	1808PPK1 Bifold Aligner 	1.2/10 1 Set/Pk.	2155PPK1 Bumper 	.8/10 1 Ea./Pk.	2378PPK2 Univ. V 3/8" Offset 7/8" Wheel 	2.2/10 2 Ea./Pk.
1506PLB2 Hinges 	2.7/10 2 Ea./Pk.	1817PPK3 Bottom Pivot 	2/10 1 Set/Pk.	2156PPK3 Guide/ Riser Set 	3/10 1 Set/Pk.	2511PPK3 Hdwe. Set 	6/10 1 Set/Pk.
1555PPK3 Converge Door Kit 	5.5/10 1 Set/Pk.	1823PPK2 Hinge 	2.3/10 2 Ea./Pk.	2216PPK2 Hanger 1/16" Offset 	2.5/10 2 Ea./Pk.	2802PLB2 Hangers 	3.7/10 2 Ea./Pk.
		1825PLBG Bifold Hdwe 	3.6/10 1 Set/Pk.				















Bulk Part #		Pkg Lbs.
10 Guide		100 1.7
11 Guide		100 1.5
12 Guide		25 1.1
13 Plug		100 1.0
14US3 2 1/8" Pull Brt. Brass		100 2.7
15US3 3/4" Pull Brt. Brass		100 0.7
15US15 3/4" Pull Sat. Nickel		100 0.7
20 1 3/4" Pull Br. Plastic.		100 1.5
21US3 2 1/8" Pull Brt. Brass		25 1.4
21US5 2 1/8" Pull Ant. Brass		25 1.4
21US15 2 1/8" Pull Sat. Nickel		25 1.4
30US3 2 1/8" Pull Brt. Brass		100 5.4
30US5 2 1/8" Pull Ant. Brass		100 5.4
30US15 2 1/8" Pull Sat. Nickel		100 5.4
32 Knob Acrylic		25 1.3







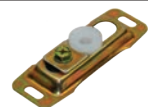



Bulk Part #		Pkg Lbs.
33 Knob Brown		100 3.0
35US3 Pull Brt. Brass		50 2.1
35US5 Pull Ant. Brass		50 2.1
35US15 Pull Sat. Nickel		50 2.1
36 Knob Wood		100 3.6
37 Knob White		100 3.0
38 Knob Brt. Brass		100 4.7
40US3 Pull Brt. Brass		50 2.2
40US5 Pull Ant. Brass		50 2.2
40US15 Pull Sat. Nickel		50 2.2
101 Univ. Guide		50 2.3
150US3 Edge Pull Brt. Brass		25 2.0
150US15 Edge Pull Sat. Nic.		25 2.0
1001 Top Pivot		25 5.0
1002 1 1/8" Door Top Pivot		25 7.5





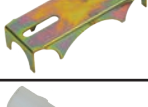
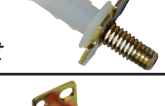
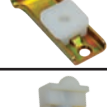
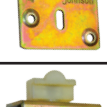
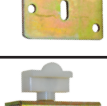

Bulk Part #		Pkg Lbs.
1003 1 3/8" Door Top Pivot		25 7.5
1004 1 3/4" Door Top Pivot		25 7.5
1010 Pivot Lock		25 8.0
1011 Floor Bracket		25 9.0
1020 Hanger 3/4" Wheel		50 6.0
1021 (1020/1025 Door Plate)		100 4.5
1023 1020 Saddle Brckt. For 3/4" Doors		50 3.3
1025 Ball-Bearing 3/4" Wheel		50 7.0
1120 Hanger 1" Wheel		50 12
1121 (1120/1125 Door Plate)		100 8.0
1122 (1 1/8" door Door Plate)		25 7.2
1123 (1 3/8" door Door Plate)		25 7.2
1124 (1 3/4" door Door Plate)		25 7.2
1125 Ball-Bearing 1" Wheel		50 16
1155 Track Stop		100 3.8





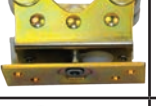

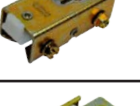
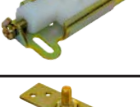
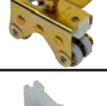
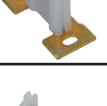
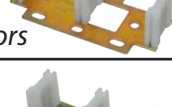

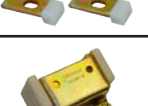
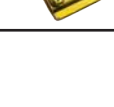

Bulk Part #		Pkg Lbs.
1461 Bottom Piv Socket		50 2.5
1506 Hinge		50 5.4
1513 Bumper		100 1.0
1550 Guide		100 2.5
1602 White Drywall Hinge		50 10
1605 Brown Drywall Hinge		50 10
1603 White Hinge		50 8.2
1606 Brown Hinge		50 8.2
1701 Top Pivot		100 5.4
1702 Top Guide <i>(obsolete)</i>		100 5.5
1703 Hinge		100 14
1704 $\frac{3}{4}$ " Floor Bracket		25 4.2
1705 Guide		100 5.5
1706 Bot. Pivot Long		100 5.3
1707 Bottom Pivot		100 4.8

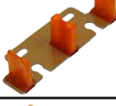
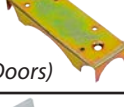
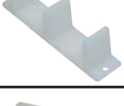
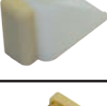
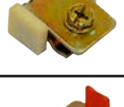



Bulk Part #		Pkg Lbs.
1710 Pivot Lock		500 2.7
1711 Jamb Bracket		50 8.2
1712 Adjusting Wrench		100 2.5
1713 Snubber		100 2.6
1714 $\frac{1}{4}$ " Floor Bracket		25 5.5
1721 Top Pivot $\frac{3}{4}$ " Doors		25 3.1
1722 <i>(obsolete)</i> Top Guide $\frac{3}{4}$ " Doors		25 3.0
1723 Bot. Pivot $\frac{3}{4}$ " Doors		25 2.9
1724 Top Pivot $\frac{1}{8}$ " Doors		25 3.2
1726 <i>(obsolete)</i> Top Guide $\frac{1}{8}$ " Doors		25 3.2
1727 Bot. Pivot $\frac{1}{8}$ " Doors		25 3.0
1728 Top Pivot $\frac{1}{8}$ " Doors		25 3.3
1729 <i>(obsolete)</i> Top Guide $\frac{1}{8}$ " Doors		25 3.3
1730 Bot. Pivot $\frac{1}{8}$ " Doors		25 3.2
1731 Bot. Guide $\frac{3}{4}$ " Doors		25 3.2





Bulk Part #		Pkg Lbs.
1732 Bot. Guide $\frac{1}{8}$ " Doors		25 3.2
1733 Bot. Guide $\frac{1}{8}$ " Doors		25 3.4
1741 Shutter Bracket		25 2.6
1742 Shutter Hanger		25 1.1
1743 Shutter. Hinge		100 4.6
1744 $\frac{3}{4}$ " High Dbl. Floor Brckt		25 8.2
1754 $\frac{1}{4}$ " High Dbl. Floor Brckt		25 11
1771 Top Pivot $\frac{3}{4}$ " Sidemount		25 4.3
1772 <i>(obsolete)</i> Top Guide $\frac{3}{4}$ " Sidemount		25 4.3
1773 Bot. Pivot $\frac{3}{4}$ " Sidemount		25 4.2
1774 Bot. Guide $\frac{3}{4}$ " Sidemount		25 4.6
1775 Doorkeeper		25 1.4
1801 $\frac{7}{16}$ " dia Top Pivot/Guide.		100 3.6
1804 Floor Bracket		25 2.0
1805 Hinge		100 8.5



Bulk Part #		Pkg Lbs.
1807 7/16" Dia Bot. Pivot.		100 4.4
1808 4-Door Aligner		100 7.5
1810 Pivot Socket		50 2.8
1811 Jamb Bracket		50 5.0
1812 Snubber 2 Door		100 1.2
1814 Snubber 4 Door		100 1.7
1815 Hinge		100 8.0
1823 Hinge		100 9.3
1831 3/8" dia Top Pivot/Guide		100 3.5
1836 Carpet Riser		25 2.3
1837 3/8" Dia Bot. Pivot		100 4.3
1861 Jamb Bracket		50 2.5
1922 Top Guide 3/4" Doors		25 3.1
1926 Top Guide 1 1/8" Doors		25 3.5
1929 Top Guide 1 3/8" Doors		25 3.5

Bulk Part #		Pkg Lbs.
1972 Top Guide 3/4" Sidemount		25 4.4
2001 Top Pivot Bifold		25 6.0
2002 Bifold Guide		25 23
2003 Ball-Bearing Hinge (pair)		10 pr. 8.5
2007 Bot. Piv Bifold.		25 10
2010 Pivot Lock		25 10
2011 Floor Bracket		25 9.0
2020 Hanger Sliding Door		25 29
2031 Heavy Duty Single Guide		25 6.0
2034 Guide 1 3/4" Doors		25 12
2035 Guide 1 3/8" Doors		25 12
2037 Guide 1 3/4" Doors		50 13
2038 Guide 1 3/8" Doors		50 13
2054PLBG Mult-Door Pull Catch		10 1.5
2055 Track Stop		25 9.0

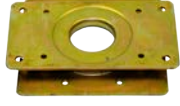
Bulk Part #		Pkg Lbs.
2118 Nylon Guide 1 1/8" Doors		25 2.2
2134 Guide 1 1/8" or 1 3/4" Doors		25 2.4
2135 Guide 3/4" or 1 3/8" Doors		100 7.5
2136 Carpet Riser (Sliding Doors)		100 4.8
2138 Nylon Guide 1 3/8" Doors		100 1.6
2155 Door Stop		50 1.6
2165 Track Stop		100 4.4
2175 Guide 3/4" Doors		25 1.8
2206 Univ. Hanger. 1/16" Offset		100 7.1
2208 Univ. Hanger. 3/8" Offset		100 7.1
2216 Hanger. 1/16" Offset		100 9.7
2226 Hanger. 1/16" Offset		50 7.4
2228 Hanger. 3/8" Offset		50 8.0
2238 Hanger. 3/8" Offset		100 11
2312 Univ. Hanger 7/8" Whl-V Trk		50 11

Bulk Part #		Pkg Lbs.
2551 Pocket Guide 1 $\frac{3}{8}$ " Doors		50 1.2
2680PLBG End Caps		50 2.3
2682PLBG End Caps		50 2.3
2802 Hanger $\frac{7}{8}$ " Wheel		50 7.6

Bulk Part #		Pkg Lbs.
2812 Hanger $\frac{7}{8}$ " Wheel		50 12
2815 Ball-Bearing $\frac{7}{8}$ " Wheel		50 13
8050 Swivel Bracket		50 22
9027 1 $\frac{3}{8}$ " Rod Support		50 8.5

Bulk Part #		Pkg Lbs.
9028 1" Rod Support		50 8.2
9029 End Bracket		50 9.2
9030PLBG Pole Caps		100 PR 5.8



Engineered Excellence

Johnson Hardware
2100 Sterling Ave.
Elkhart, IN 46516
PH: 800-837-5664
Fax: 800-837-4697