

MULTI FAMILY

2026



PRODUCT GUIDE



MULTI-FAMILY / RESIDENTIAL

TABLE OF CONTENTS 2, 3

WHY US? 4, 5

COMMON AREAS

DIVISION 8 - OPENINGS

Aluminum Entrance Systems 6, 7

IP Intercoms 8, 9

Novatech Patio Doors

 Studio 10, 11

Model 630 12, 13

Front Entrance | Balcony Storage | Garage Doors by Madero 14, 15

Hollow Metal Frame Options 16 - 19

Hollow Metal Doors 20, 21

Aluminum Wall Systems Interior 22, 23

Assa Abloy Accents Access Control 24, 25

Allegion Access Control 26, 27

Automatic Door Openers 28, 29

Hardware Common Areas 30 - 35

DIVISION 10 - SPECIALTIES

Mailboxes 36

Parcel Lockers 37

Roof Access Doors & Hatches 38

Garbage & Laundry Chutes 38

Tenant Storage 39

Lockers 39

Bike Racks 41

Floor Mats & Grilles 42

Pet Washing Stations 43

Toilet Partitions 44

Washroom Accessories 45



ASSISTED LIVING

SUITE ENTRIES

DIVISION 8 - OPENINGS

Doors	46, 47
Frame Options.....	48, 49
Dexter & Schlage Locks.....	50, 51
Weiser Locks	52, 53
Hardware Options.....	54, 55

SUITE INTERIORS

DIVISION 8 - OPENINGS

Doors - Moulded and Shaker Panel.....	56, 57
Doors - Glass Panel.....	58
Doors - Barn Doors c/w Hardware.....	59
Doors - Bypass Doors & Hardware	60, 61
Frame Options.....	62, 63
Hardware - Pocket Kits	64
Hardware - Sliding Kits	64
Hardware - Bypass Kits	65
Hardware - Barn Track Kits.....	65
Pocket Door Locks	66
Sliding & Barn Door Latching Hardware.....	67
Sliding & Barn Door Pulls.....	68, 69

DIVISION 10 - SPECIALTIES

Mirrors & Medicine Cabinets.....	70
Closet Organizers.....	72
Mouldings.....	72





CONDOMINIUMS APARTMENTS TOWNHOUSES

As a primary vendor of building materials in Division 8 Openings and Division 10 Specialties, we are involved in all facets of a project.

This catalogue is representative of the goods we supply to the MFR industry.

West Four Aluminum is a division within our company that has been fabricating aluminum doors, frames and wall systems for over thirty years.

We are a distributor of, and fabricate, hollow metal doors and frames in Calgary, Edmonton, Red Deer, Saskatoon and Winnipeg. Our experience is built on forty years in this industry.

Recently appointed as Distributor for Western Canada - the complete catalogue of Novatech patio door systems is now available through us. We are happy to expand our partnership with Novatech, having used their residential steel doors for the past 15 years.

We distribute for all major Architectural door manufactures. Automatic Operators, Access Control, Residential, Commercial and Architectural options are available to match your requirements.

Division 10 can be an expansive list in every building. We spec it, source it and sell it.

Labour shortages add costs to any project. Consider ordering preassembly, prefinished and hardware installed.

ASSISTED LIVING STUDENT HOUSING



WEST **FOUR**
Aluminum

ALUMINUM ENTRANCE SYSTEMS



Designed specifically for front entrances of Apartments and Multi Family complexes.

Units are pre-glazed, pre-assembled and drilled for ease of install.

Factory installed hardware.

Optional automatic openers.

Available Finishes:



Clear
Anodized



Dark
Bronze
Anodized



Powder
Coated
Black



IP INTERCOMS



IP INTERCOMS

For residential multi-tenant and commercial buildings.

- Modular Design
- Central Door Control
- Keyless Access
- Remote Access



Novatech[®]
PATIO DOORS

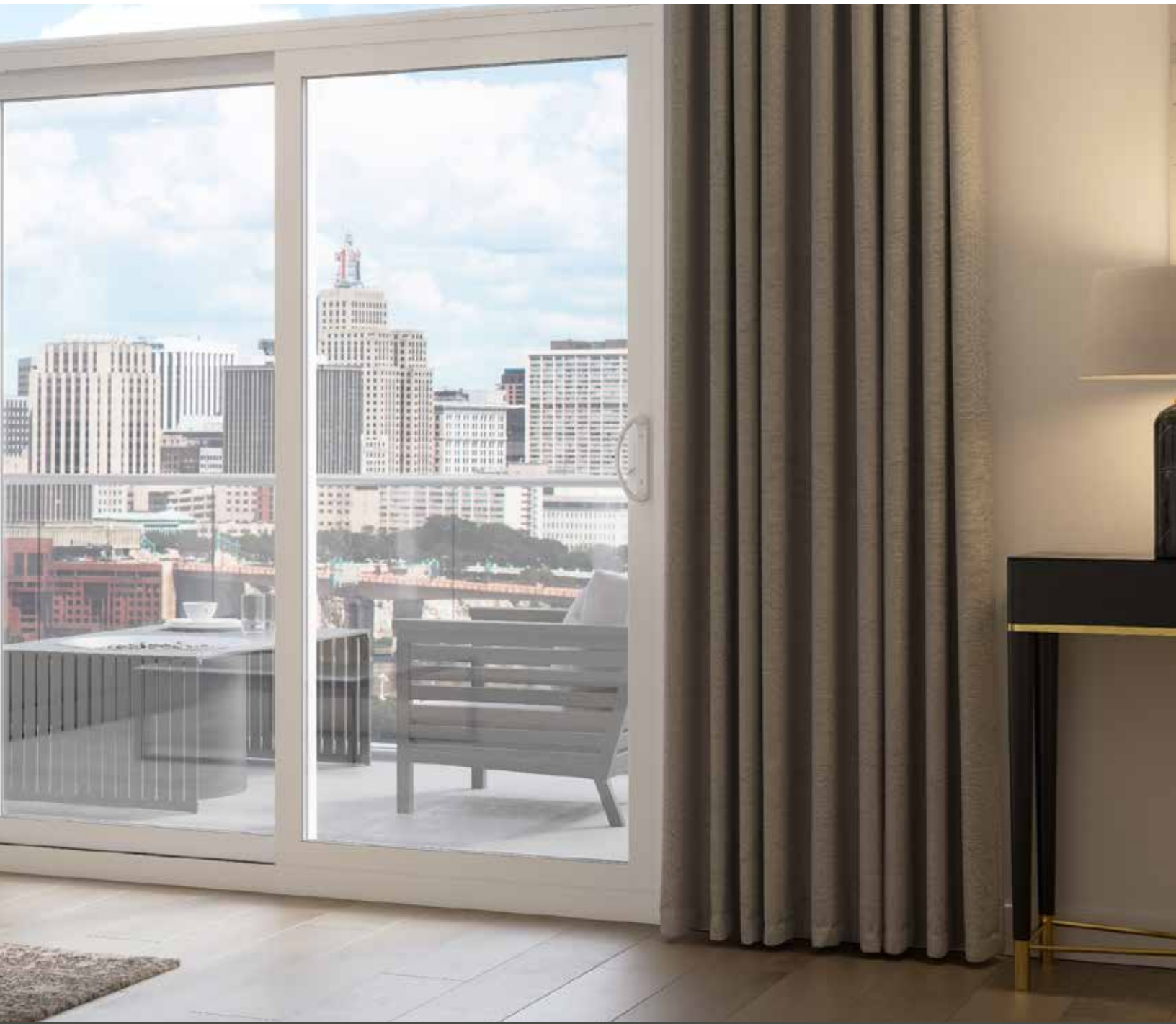

THE STUDIO PATIO DOOR

The Studio patio door exceeds industry performance standards. Ideal for high-rise projects, this door is built to withstand the weather and high winds at the top. Studio is a flexible aluminum patio door designed for architectural uses with multiple customization options.

Available Finishes:

-  Clear Anodized
-  Commercial Brown
-  Black



Novatech[®]
PATIO DOORS



THE 650 PATIO DOOR

Designed with ease of installation in mind, the 650 boasts a multiple of features that make it adaptable to your construction project, while providing superior energy efficiency to meet the Energy Star standard.



M Madero

EXTERIOR DOORS



BALCONY STORAGE | FRONT ENTRY | GARAGE ENTRY

Madero's door systems are tailored to withstand the extreme Canadian climate. A versatile program featuring exterior door openings using steel and fiberglass slabs, partnered with wood, composite or aluminum clad frames. Maintenance free and factory finished options available.



VISION
HOLLOW METAL LIMITED

DAYBAR

HOLLOW METAL WELDED FRAMES

Usage: Interior or exterior – residential, commercial or industrial.

Single Opening

16 gauge galvanized steel is fully welded across the visible side of both faces. Exposed welds are ground, finished and prime painted. Each frame will have two spreader bars tack welded in place and are to be removed before installation. The spreader bars are used to square the frame and keep it stable during shipping to site.

Fire Rating	Up to 180 minute
Rough Opening	Width = Nominal door width plus 4-1/4" Height = Nominal door height plus 2-1/4"
Finishing	Galvanized steel is matte grey and ready for the finish paint - primer is not required

MODEL	JAMB DEPTH	THROAT*
AS 4-3/4"	4-3/4" (121mm)	3-3/4" (95mm)
AS 5-3/4"	5-3/4" (146mm)	4-3/4" (121mm)
AS 6-3/4"	6-3/4" (172mm)	5-3/4" (146mm)
AS 7-1/4"	7-1/4" (184mm)	6-1/4" (159mm)
AS 7-3/4"	7-3/4" (197mm)	6-3/4" (171mm)
AS 8-3/4"	8-3/4" (222mm)	7-3/4" (196mm)

* Throat size should match wall thickness. It is common for throat sizes to exceed wall thickness by 1/8". Caulking is used to fill any additional spacing.

Hinge & Strike Preparation

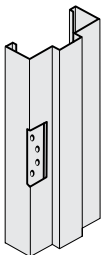

4-1/2" (114) hinge preparation - 10GA. (3.4) reinforced with dust box.

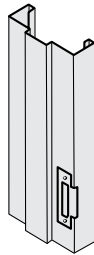

4-7/8" (124) strike preparation [ANSI A115.1] - 14GA. (2.0) reinforced dust box.



Hollow Metal Door with Closer and Commercial Hardware

Wall Anchor Styles

Fully welded frames are designed to be installed during wall construction and come with welded base angles on each jamb for securing to the floor. Each frame is supplied with masonry, wood stud anchors or steel stud anchors as required.

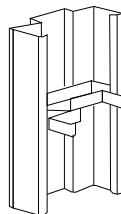

Adjustable stud anchor

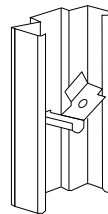

Existing masonry anchor

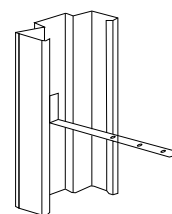

Masonry strap anchor

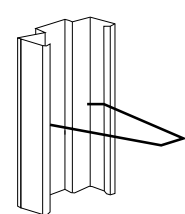

Masonry wire anchor

EXPANDABLE EF-K FRAME SERIES (REVERSIBLE)

REVERSIBLE SQUARE CORNER - 18 GA. STEEL

Expandable frames are an ideal solution for commercial building applications and retrofit work on existing buildings, especially when existing wall types are unknown or vary throughout the project. For new construction, the reversible handing and ease of installation make this a frame of choice for installers.

Nominal Door Size	Actual Door Size	Rough Opening	Swing
2/8 x 6/8	31-3/4" x 79-1/8"	33-3/4" x 81"	Reversible
3/0 x 6/8	35-3/4" x 79-1/8"	37-3/4" x 81"	Reversible
2/8 x 7/0	31-3/4" x 83-1/8"	33-3/4" x 85"	Handed
3/0 x 7/0	35-3/4" x 83-1/8"	37-3/4" x 85"	Handed

Standard Series

Expandable from 4-1/2" to 7-7/8"
Expandable from 7-5/8" to 12-1/2"

Fire Rating

20 to 90 minute

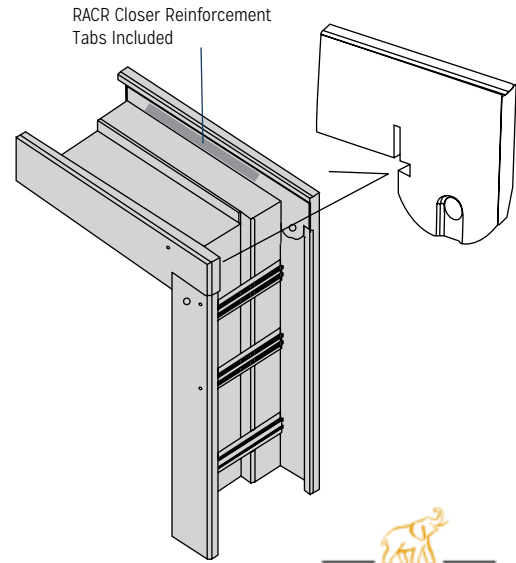

EXPANDABLE EF FRAME SERIES (NON-REVERSIBLE)

DAYBAR

EF MITRED CORNER - 16 GA. STEEL

EF Series frames are designed to accommodate the broadest range of wall construction with a single adjustable product. EF Series features a two piece frame component, held together with a bracket system and spot welded to the frame material, allowing the jamb depth to be reduced or increased based on site conditions.

NOMINAL DOOR SIZE	ACTUAL DOOR SIZE	ROUGH OPENING	SWING
2/8 x 6/8	31-3/4" x 79-1/8"	33-3/4" x 81"	Handed
3/0 x 6/8	35-3/4" x 79-1/8"	37-3/4" x 81"	Handed
2/8 x 7/0	31-3/4" x 83-1/8"	33-3/4" x 85"	Handed
3/0 x 7/0	35-3/4" x 83-1/8"	37-3/4" x 85"	Handed

EF-1

Expandable from 3-1/2" to 5-3/4" wall thickness

EF-2

Expandable from 5-1/2" to 8-3/4" wall thickness

EF-3

Expandable from 8-1/2" to 13-1/4" wall thickness

Fire Rating

20 to 90 minute

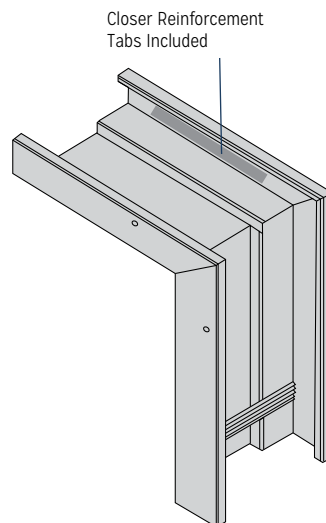

EF Frame

DRYWALL FRAMES (DW)

DAYBAR

NOTE: For 1-3/4" door thickness.

One person can install drywall frames quickly and efficiently.

Usage: Interior - commercial or industrial

Installation

Drywall frames are supplied in three pieces and are installed after the framing stage. Jambs have corner tabs spot welded at the mitre, interlocking with slots on the frame head. This tab is then bent over to make a tight joint. Each jamb has a dimpled base anchor for fastening to the floor plate and tension anchor at the top.

Reinforcements

Reinforcements are welded to the frame for three hinges and strike placement. The strike jamb leg is prepped for a 4-7/8" ANSI strike.

JAMB DEPTH	THROAT*
4-1/2" (114mm)	3-1/2" (89mm) <i>Special Order</i>
5-5/8" (143mm)	4-5/8" (118mm)
5-7/8" (149mm)	4-7/8" (124mm)
6-1/4" (159mm)	5-1/4" (133mm) <i>Special Order</i>
7-3/4" (197mm)	6-3/4" (172mm) <i>Special Order</i>
8-1/4" (210mm)	7-1/4" (184mm) <i>Special Order</i>

* Throat size should match wall thickness. It is common for throat sizes to exceed wall thickness by 1/8". Caulking is used to fill any additional spacing.

Fire Rating

20 to 90 minute



Rough Opening

Width = Nominal door width plus 2"

Height = Nominal door height plus 1-1/4"

Finishing

Galvanneal steel is matte grey and ready for the finish paint - primer is not required

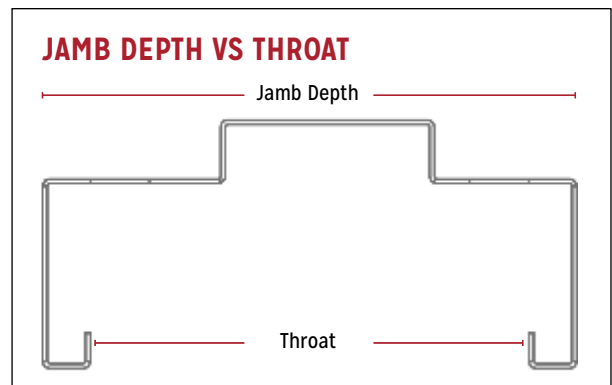



HOLLOW METAL DOOR OPTIONS

Hollow Metal doors are available in 20, 18, or 16 gauge for commercial and industrial usage. Lockseam (LS) doors are made from Galvanneal steel. They are available in honeycomb core for interior use, insulated with polystyrene or polyurethane for exterior applications and sound transmission control. Fire rating to 3 hours. Also available with temperature rise core.

Widths: 2/0 to 3/0, in 2-inch increments as standard, 3/6, 4/0

Heights: 6/8 or 7/0, in 2-inch increments as standard

Maximum sizes for double doors: 8/0 x 8/0.

Custom, non-standard and oversize also available.

GLAZING OPTIONS

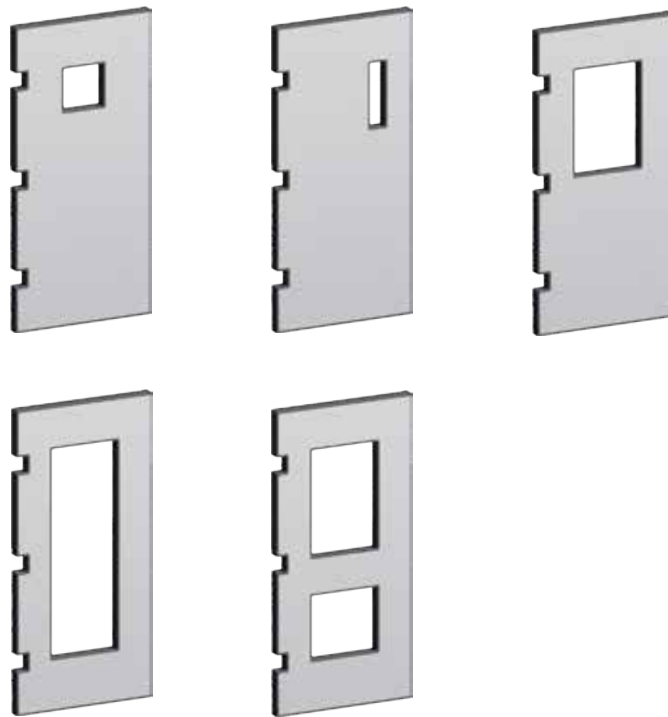

GLASS TYPES

Clear

Clear Low E with Argon.

Rockglass is lighter, stronger and more impact resistant than regular glass. Shatter Proof | Impact Resistant | Anti-Intrusion

Pyran is a fire resistant glazing made from borosilicate - single safety glass.

Pyran S is a double glazed unit offering extra insulation and protection.

Protect3 replaces GPW glass. It is 1/4" (6.8mm") thick glazing material consisting of fire rated wire glass with a factory applied fire rated and impact safety rated film.





WEST FOUR
Aluminum

WEST FOUR ALUMINUM

For common areas, meeting rooms, gymnasiums and other centralized facilities. Aluminum wall systems are functional and structural. Custom made to your specifications.



WALL SYSTEMS SPECIFICATIONS



Horizontal | Midrail

NOTE: Custom midrail placement is available.



Vertical | Midrail

NOTE: Custom midrail placement is available.



Seamless | Silicone Joints



Vertical and Horizontal | Midrail

NOTE: Custom midrail placement is available.

DOOR LEAF TYPES



Glass Wall with Swing Door



Sliding with Aluminum Door

Available Frame Finishes:



Clear Anodized, Dark Bronze Anodized, Powder Coated Black

Glass Options:



Clear Tempered, Frosted Tempered



ACCENTRA

ASSA ABLOY

Assa Abloy Accentra™ offers a host of commercial-grade door hardware, including an extensive range of mortise and cylindrical locks, exit devices, door closers, electromechanical products and keyed systems.

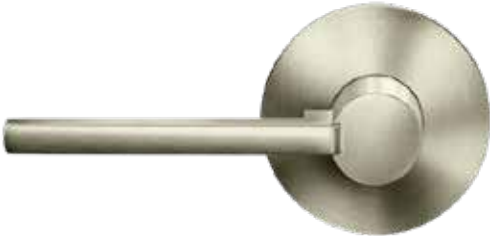

NEXTOUCH® INTERCONNECTED

Assa Abloy Accentra™ nexTouch® Interconnected lock combines electronic deadbolts with the convenience of a passage lever for panic proof egress. From the inside, both the latchbolt and the deadbolt are retracted simultaneously in a single motion for a quick and easy exit. Choose from 12 lever styles.

Available Finishes:

-  Oil Rubbed Bronze, Permanent
-  Satin Nickel Plated, Clear Coat
-  Black Suede, Powder Coated

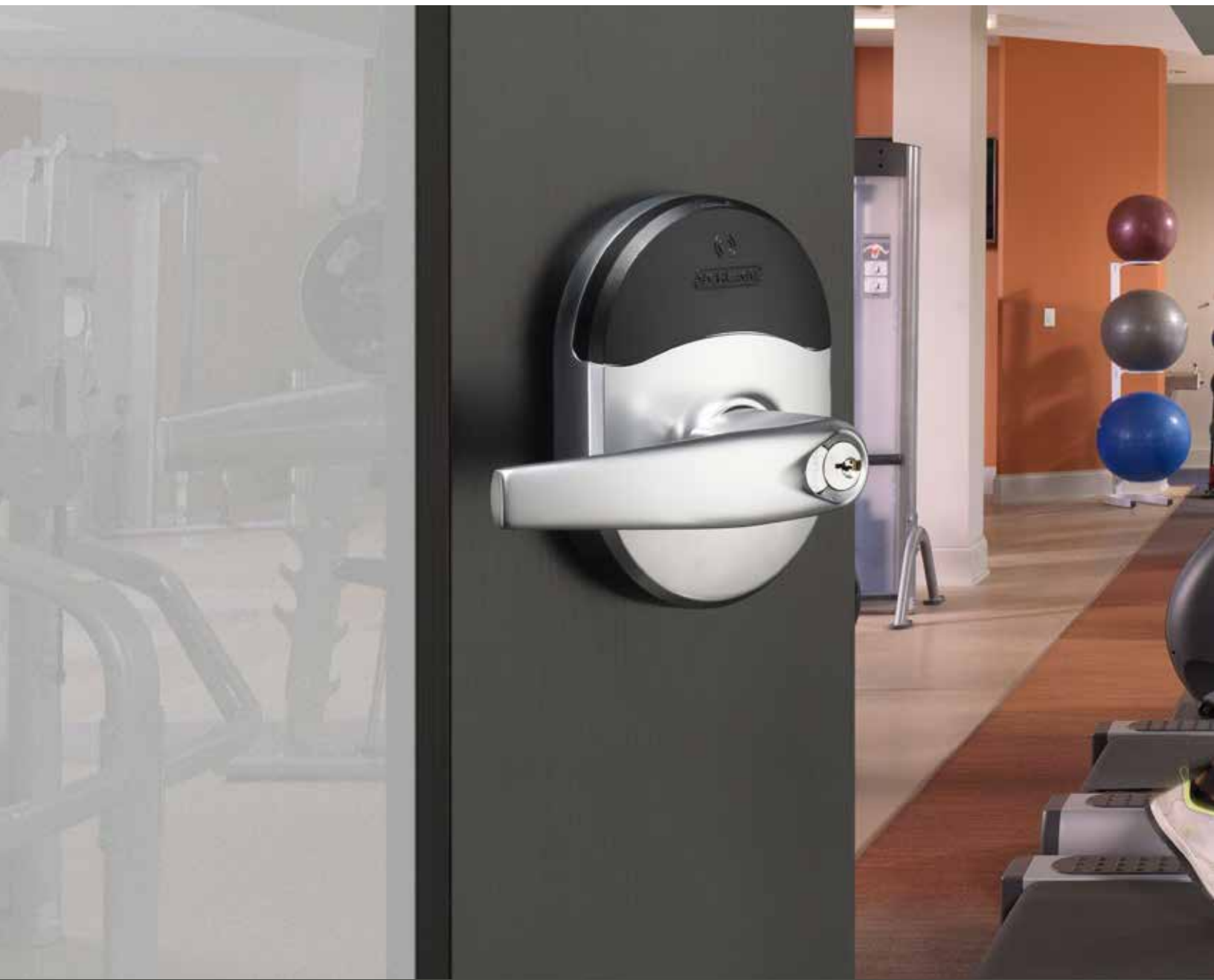

ALLEGION™ 

ENGAGE™ for Access Control



SCHLAGE NDE MOBILE ENABLED WIRELESS CYLINDRICAL LOCK

- Refined design for doors with cylindrical prep
- Includes interior push button with indication for additional functionality
- Compatible with Bluetooth and NFC mobile, smart and proximity credentials





ALLEGION  

ALLEGION PRODUCTS

Deliver the value of electronic security with wireless solutions to more doors, more ways.

Schlage Control comes standard with ENGAGE™ technology, which provides connectivity and lock management for facilities staff through the ENGAGE app. This technology also allows residents to gain access using sophisticated smart technology. From a smart phone, tablet or computer, you can quickly add users, view a history of access, get data, receive alerts and more.

SCHLAGE XE360 SERIES WIRELESS MORTISE LOCK

The Schlage XE360 series of wireless locks from Allegion US is a keyless entry system designed specifically for use in multifamily properties. The locks feature a slim silhouette and modern-style handle in a choice of three finishes. The locks can be used both on resident doors and in common areas.



Optimized for Multi-Family



Greenwich

Addison

SCHLAGE LE MOBILE ENABLED WIRELESS MORTISE LOCK

- Elegant design for doors with mortise prep
- Choose Greenwich or Addison trim
- Options include mortise and mortise deadbolt
- Compatible with Bluetooth and NFC mobile, smart and proximity credentials.

SCHLAGE CONTROL MOBILE ENABLED SMART DEADBOLT AND INTERCONNECTED LOCK

- Smart deadbolt options for resident entries
- Choose Greenwich or Addison trim options
- Interconnected design enables single-motion egress
- Compatible with Bluetooth mobile and smart credentials.



Greenwich

Addison

Greenwich

Addison



AUTOMATIC DOOR OPERATORS

RECORD HA7 SLIM LOW ENERGY OPERATOR



- **EASY INSTALL**

Install is quick and easy with no electrician needed. 120V outlet compatible.

- **CUSTOM FUNCTIONS**

Make the HA7 work for you by customizing preferences for a more personalized experience.

- **DOOR CONTROL**

Features like partial open, hold open, push & go, power assist, and stop on stall are all at your fingertips.

- **MULTI-PLATFORM ACCESSIBILITY**

Available through both the Apple and Google Play stores means more control for more people.



low energy



app controlled



one-hour install



push & go



ADA



Record HA8 in clear with push arm



Record HA8 in bronze with pull arm

RECORD HA8-SP STANDARD PROFILE LOW ENERGY OPERATOR

HA8-SP is the standard profile low-energy operator that works in every application including high-traffic and exterior. The standard profile can be installed in hospitals, retail stores, schools, airports, convention centers, industrial buildings, and offices.



Record HA9 in bronze with pull arm



Record HA9 in clear with push arm

RECORD HA9 FULL FEATURED LOW ENERGY OPERATOR

HA9 is a low-energy operator loaded with features while offering the same quiet, dependable operation you've come to expect in a low-profile header size. The HA9 is perfect for high-traffic locations including schools, hospitals, retail stores, airports, convention centers, industrial buildings, and offices.

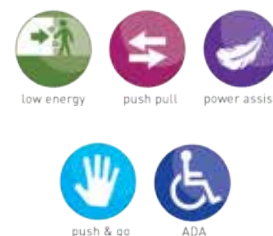



EXIT DEVICES & TRIM

DOREX 8500 SERIES EXIT DEVICES & TRIM

The Dorex 8500 Series exit device offers a sophisticated contoured design and is available with a variety of exterior trim options. This exit device is ideal for moderate use wood or hollow metal door applications.



DOREX®

VON DUPRIN ALLEGION 22EO SERIES EXIT DEVICES & TRIM

Ideal for back door employee entrances or parking garage stairwells, the Von Duprin 22 Series exit devices are designed for clinic/healthcare, multi-family, or retail/commercial markets.

It is available in several rim and surface vertical configurations and can be combined with electronic options such as request to exit (RX) latch retraction (LX), quiet electric latch retraction (QEL) and exit alarm (ALK).



VON DUPRIN®



FALCON KNOB, LEVERS & DEADBOLT

For use in public entry areas.

Contains UL rated latch to comply with 20, 45 and 90 minute fire rating requirements.

- Reliable and proven Grade 2 construction
- Heavy duty springs for better lever return and to prevent sagging
- Non-handed for easy assembly
- Schlage C masterkey available



FALCON.
a division of Allegion
Hardware



Hana Knob
626



Dane Lever
626



Quantum Lever
626



241P6F
626

DIVISION 8 - OPENINGS



MAIL

- 921A
- 921B
- 921C
- 921D
- 921E
- 921F

- 1021A
- 1021B
- 1021C
- 1021D
- 1021E
- 1021F

DOOR CLOSERS

DOREX® FALCON®

DOREX 700 SERIES DOOR CLOSERS

The Dorex 700 Series fixed power door closer is recommended for use on a wide variety of residential and commercial applications with moderate traffic.

FALCON SC90 SERIES DOOR CLOSERS

Designed for light to moderate duty and for interior/exterior applications, the Falcon Series closers ensure smooth and reliable operation while meeting ADA accessibility requirements. The SC90 series is preset for easy installation.

SC61 SERIES DOOR CLOSERS

When you need a dependable closer for a standard-duty application, the SC61 closer gets the job done. Designed for commercial exterior, interior and aluminum storefronts, it features the most common hole pattern in the door control industry making it ideal for a variety of retrofit needs.



THRESHOLD AND WEATHERSTRIP

PENKO
ASSA ABLOY

18100 NB NYLON BRUSH SEAL

The 18100 NB Nylon Brush seal with 180 degree retainer and 1" brush is designed to seal the gap under and around doors. It features densely compressed nylon filaments that are highly flexible and conform well to surface irregularities. The casing measures 7/8" high and the brush portion has a height of 1".

172 SERIES COMMERCIAL FLAT SADDLE THRESHOLD

The 172 Series Commercial Flat Saddle Threshold is designed to create a smooth transition under a door. It's 1/2" high and 6" wide and available in different finishes to suit various aesthetic preferences. This threshold is rated for barrier-free, BHMA certified, and fire-rated applications.



ALLEGION™ 



MAILBOXES

Vertical or horizontal, recessed wall mounted mailboxes.

Applications: Apartments, condominiums, commercial or industrial spaces.



PARCEL LOCKERS

With the growth of online shopping, parcel lockers are now a necessity in multi-family buildings. Both standard and custom configurations are available.

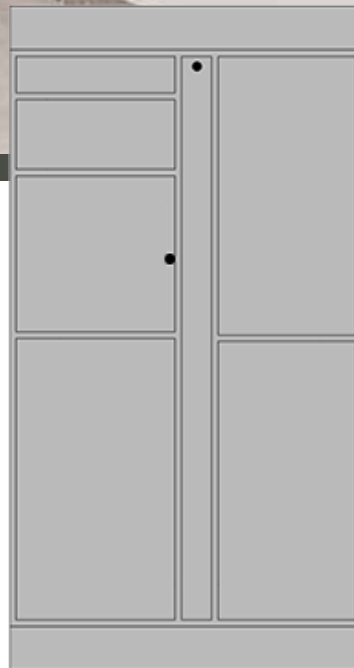

5 Door



12 Door



ACCESS DOORS & HATCHES

Our roof hatch product offering includes a complete line of roof access and safety products.



GARBAGE AND LAUNDRY CHUTES

Fire-rated standard chute doors for garbage, linen or recycling systems.



TENANT STORAGE

Designed specifically for the condominium industry, storage lockers are available free standing, floor to ceiling or hanging. Made of heavy duty welded wire mesh, the galvanized finish provides years of maintenance free protection.



hadrian®

LOCKERS









Hadrian offers durability beyond the restroom with heavy-duty steel lockers, designed for effective storage that complements any space.





BIKE RACKS

A Canadian-made product, Cora Bike Racks will support 2 to 10 bikes. Different lengths, colours and finishes are available, all for the purpose of security and safety.

<p>EXPO SERIES</p>	 W4508	 W5808	 W7510
<p>WALL MOUNTS</p>	 VWM002 (Hanging Bikes)	 HWM002	 LWM002
<p>STAPLE RACK</p>	 SRA002 (No Hanger) The Staple	 SRC002 The Tree	 SRE002 The Oval

FOOT GRILLES & FLOOR MATS

KN Crowder



MAT SYSTEMS

Choose entrance mat systems that perform and provide lasting durability by helping to stop dirt and moisture from reaching your interior floors.



GRID SYSTEMS

Entrance grids are the ultimate dirt-trapping systems featuring superior fall-through to keep debris from being tracked into your building.



STAINLESS STEEL GRIDS

As pedestrians enter your building, stainless steel grids provide excellent scraping performance with high-tech yet durable aesthetic.



SPECIALTY FLOORING

The designer's choice for entrance flooring. It not only performs, it enhances your entrance and the critical first impression it makes.





PET WASH STATIONS

Pet wash stations are being added in many parkade areas. There are several models and sizes to choose from.



62" Stainless Steel
Pet Bathing Station
with Ramp



50" Stainless Steel
Pet Bathing Station
with Stairs



50" Stainless Steel Pet
Bathing Station with
Height Adjustment

TOILET PARTITIONS

hadrian®



SOLID PLASTIC



STAINLESS STEEL



POWDER COATED



PHENOLIC

Custom colours and designs available.
Upgraded designer hardware in matte black or brushed stainless steel.
Fireproof, waterproof and easy to clean.
25-year warranty.

WASHROOM ACCESSORIES



MATTE BLACK ACCESSORIES FOR OUTSIDE & INSIDE THE CUBICLE

SOAP DISPENSERS
& FAUCETS



PAPER TOWEL DISPENSERS
& WASTE UNITS



NAPKIN &
TAMPON
VENDORS



MIRRORS



HAND DRYERS



BABY CHANGING
STATION



MOBILE DEVICE HOLDER



dyson

Airblade Wash-Dry Hand Dryer
AB09 / AB10
With Airblade technology in a tap, hands can be dried at the sink in 14 seconds. There's no need to move to a separate hand drying area.



Architects and engineers turn to Bradley for the industry's most innovative products specified for commercial washrooms and industrial safety applications.



From hand dryers and hair dryers, to vacuums, purifying fans and lighting, Dyson technology is engineered with your employees and guests in mind.



Frost has earned a reputation for manufacturing quality washroom products that offer both durability and value.



ASI is the world's leading manufacturer of commercial partitions, washroom accessories, lockers, and visual display products. ASI designs, engineers, and manufactures fully-integrated solutions so all products work together seamlessly.

DIVISION 8 - OPENINGS



SUITE ENTRY | WOOD DOORS - 20 MINUTE RATED

Mix n' Match: 1-3/4" wood doors, rated wood jambs, hollow metal doors and frames.
Standard templates will apply.



3PEK
3 Panel Equal
Smooth Shaker



1PK
1 Panel
Smooth Shaker
Lincoln Park



3PK
3 Panel Craftsman
Smooth Shaker
Winslow



2PK
2 Panel
Smooth Shaker
Logan

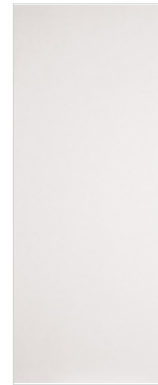

Primed Hardboard
MDF

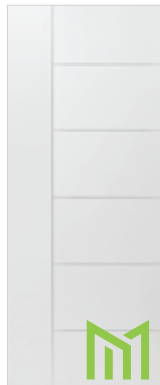

Berkley
6 Panel Equal with
1 Vertical Panel

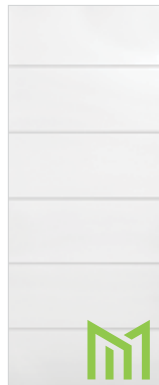

Melrose
6 Panel Equal
(Not recommended
for double doors)



5PSM
5 Panel Smooth
6 Panel 96"
Riverside



2PSM
2 Panel Smooth
Carrara

NOMINAL SIZE	ACTUAL SIZE	THICKNESS	BEVEL
2/8 x 6/8	31-3/4" x 79-1/8"	1-3/4"	2 Edge
3/0 x 6/8	35-3/4" x 79-1/8"	1-3/4"	2 Edge
2/8 x 7/0	31-3/4" x 83-1/8"	1-3/4"	2 Edge
3/0 x 7/0	35-3/4" x 83-1/8"	1-3/4"	2 Edge

PAINT Paintable, primed smooth surface.
Factory pre-finishing upon request.

PREHUNG Optional prehunging in wood jambs. Saves time
and money on job site.

A 20 minute rated door meets requirements for a 60 minute wall rating. 

PRE-FINISHING

Select from these popular colour choices.
Contact for more details.





SUITE ENTRY | WOOD FRAMES - 20 MINUTE RATED

Fire rated doors are often used for house and garage applications or as entrances to Multi-Family dwellings. All 20 Minute fire rated frames are available in 4-9/16", 6-3/4", 7-7/8" or 9". Custom upon request. Machined and labelled in factory - standard sizes will see the door slab 1/4" undersized in width, and 7/8" in height.

WITH KERF WEATHERSTRIPPING

Primed, kiln-dried finger-jointed pine jambs provide beauty and strength with a Warnock Hersey certified 20 minute fire rating. Suitable for interior or exterior use. Weatherstrip available in black or white.



Frame with Kerf Weatherstripping

WITHOUT KERF WEATHERSTRIPPING

Primed, kiln-dried finger-jointed pine jambs comply with a Warnock Hersey 20 minute fire rating. Optional adhesive smoke seal can be used with this jamb for extra sound and smoke protection.



SUITE ENTRY | HOLLOW METAL FRAMES - 20-90 MINUTE RATED

EXPANDABLE EF-K FRAME SERIES (REVERSIBLE HANDING)

The EF-K Series are an ideal solution for commercial building applications and retrofit work on existing buildings, especially when existing wall types are unknown or vary throughout the project.

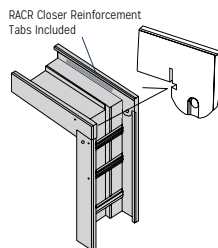

EXPANDABLE EF FRAME SERIES (NON-REVERSIBLE)

EF Series features a two-piece frame component, held together with a bracket system and spot welded to the frame material, allowing the jamb depth to be reduced or increased based on site conditions.

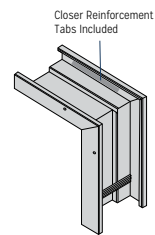

K SERIES DRYWALL FRAMES

K Series Standard are for use with 1-3/4" steel or wood doors. They are available in a variety of standard and non-standard sizes for use in a broad range of wood or metal stud wall constructions.

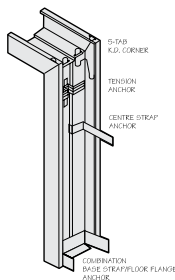

WELDED FRAMES

Welded frames are intended for installation during wall construction and are recommended for a wide variety of interior or exterior commercial, industrial, and residential applications. They are brake-formed for tight fitting mitres.

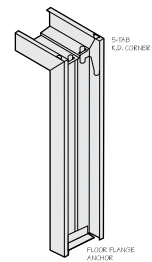

Innovative Multi-Family
Lock Solutions For
Every Budget



DEXTER DEADBOLTS & LEVERS

Must be specified to contain UL rated latch to comply with fire rating requirements.

- Strongest locks in the opening price point category
- Dexter designs corresponds with Schlage's most popular designs
- May be keyed to the Schlage C keyway
- Dual or triple option latches come standard
- Fits standard door preps
- Easy to install



Solstice/Collins
619, 625, 626, 716



Seville
619, 625, 716



Stratus
619, 625, 716



Corona
630



Broadway Collins
619



Marin
619, 630

FIRE-RATED HARDWARE

Finishes Available



619
Satin Nickel



625
Bright Chrome



620
Antique Pewter



626
Satin Chrome



630
Satin Stainless Steel

SCHLAGE KEYPED LEVERS & DEADBOLTS



Must be specified to contain UL rated latch to comply with 20 minute fire rating requirements.

- Fits all standard door preps, with lever designs reversible in-field.
- Installation is easy with posts that guide the screw into the proper location.
- Master keying and construction keying available upon request.

LEVERS & KNOBS | F-SERIES



Broadway Family

716, 622, 619



Latitude Family

716, 622, 619, 626



Bowery Family

716, 622, 619



Accent Family

716, 622, 620, 619, 608

DECORATIVE COLLECTIONS



Latitude | Collins

622, 619



Latitude | Century

622, 619

DEADBOLTS



B60F

619, 622, 625, 716, 626

Finishes Available



608

Satin Brass



619

Satin Nickel



620

Antique Pewter



622

Matte Black



626

Satin Chrome



716

Aged Bronze

SCHLAGE CONTROL™ SMART LOCKS

Schlage Control Smart Deadbolt locks are ideal for multi-family communities, senior living communities and student housing.

Benefits:

- Increases efficiency of property operations.
- Easy Installation.
- No cylinder design eliminates traditional keys.



BE467F GRW 619

Greenwich trim with Broadway lever in Satin Nickel
Lever sold separately



BE467F ADD 716

Addison trim with Accent lever in Aged Bronze
Lever sold separately

Innovative Multi-Family
Lock Solutions For
Every Budget



WHY SAFELOCK BY WEISER?



- Safelock meets the ANSI/BHMA Grade 3 performance standards for residential hardware. All locks pass an extensive series of heavy-duty, intense testing procedures to ensure quality and performance.
- Safelock is a cost-effective door hardware solution for builders. It combines trusted security and performance with traditional and contemporary styles, finishes that will enhance any home.



Daylon - 3 Finishes



Reminy - 2 Finishes

KEY CONTROL DEADBOLT

The Key Control Deadbolt is the perfect solution for multi-family dwellings and rental complexes. Features a property manager cylinder and tenant cylinder so both users have individual access to the same property. The deadbolt features SmartKey re-key technology so either cylinder can be re-keyed in seconds.





HALIFAX SMARTKEY LEVER & DEADBOLTS



PASSAGE PRIVACY LEVER - HALIFAX

With Weiser you can blend simplicity with elegance. The privacy option can be locked or unlocked by push button inside. An emergency key is provided. Universal handing and can be installed in minutes.



KEYED LEVER WITH SMARTKEY - HALIFAX

Weiser has traditional and contemporary styling to match all décor types. Levers can be locked or unlocked by a key on the outside, or push button on the inside. Must be ordered with a Firecan for 20 minute fire protection.

SMARTKEY DEADBOLT - ELEMENTS

Elements by Weiser provides an expanded choice styles and finishes at an affordable price. This single cylinder deadbolt can be locked and unlocked by a key on the outside, or the turn piece on the inside. The rich tones add the finishing touch to this product.

Ordered with FireCan for 20 minute fire rating.



Fire Doors

A fire door is a closure and it includes frame, doorknob (self-latching), hinges or closer (self-closing) to make the assembly complete. All components within the assembly must have a fire-protection UL rating. Some jurisdictions require a door viewer for certain applications.

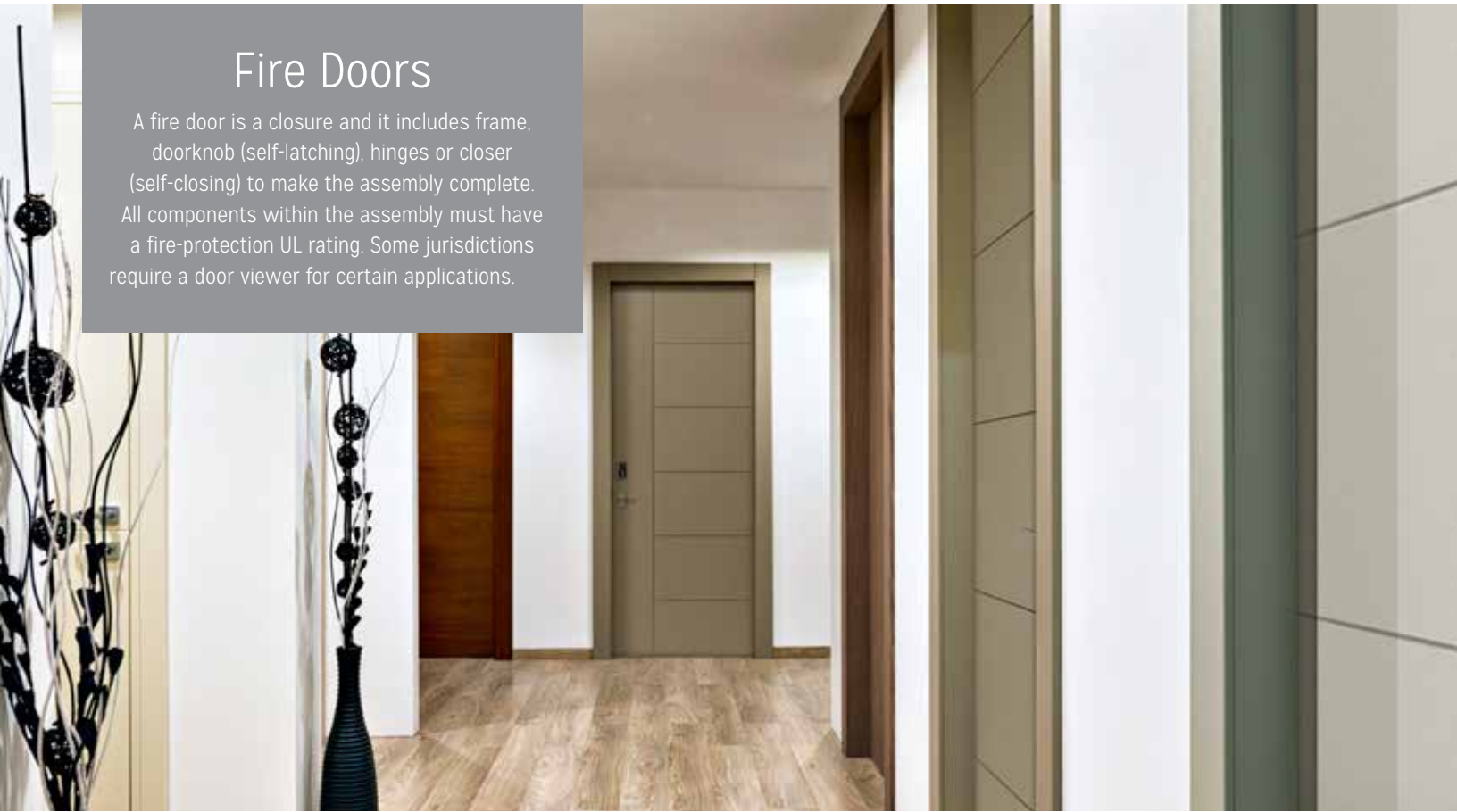

SC90 SERIES DOOR CLOSERS

Falcon Series closers ensure smooth, reliable operation, while meeting ADA accessibility requirements. Designed for light to moderate duty, interior/exterior applications and preset for easy installation.

FALCON
a division of Allegion
Hardware



SELF-CLOSING HINGES

- Satin Chrome and Matte Black finish.
- Quality wood screws and undercut machine screws are included.

INSTALLATION

- 2 required. Recommended installation—middle and lower hinge placement. Eliminates the weight bearing strain on the top hinge.

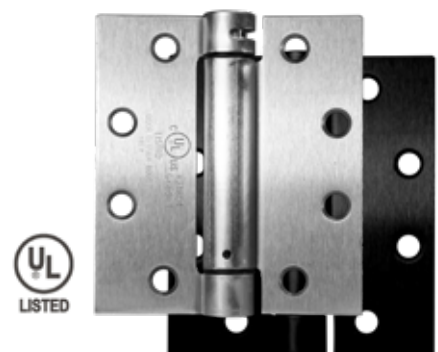

DOOR VIEWER

CalRoyal ULDV200 Viewer

Finishes: 15 - Satin Nickel

10B - Oil rub Bronze

26 - Bright Chrome

26D - Satin Chrome

4 - Satin Brass

- For doors 1-3/8" to 2" thick.
- Bore 9/16".
- 200 degree glass lens.
- UL Listed for 90 Minutes / ANSI BMHA.



SMOKE SEAL

S88BL Pemko

Specifications

- Silicon polymer, self adhesive, black.
- Effective temperature range of -58° to +450° Fahrenheit (-50° to +232° Celsius).
- Not affected by mildew, fungus or ultra-violet light.



AUTOMATIC DOOR BOTTOM

Pemko 4301 PKL

Specifications

- Low closing force.
- End plates provided for all mounting applications.
- Slotted holes for adjustment.



Surface Applied

Pemko 411 APKL

Specifications

- Smoother action positive seal mechanism.
- Available in any size ranging from 18" to 48".



Mortised Automatic

DOOR NUMBERS

Specifications

- Made of solid brass.
- 4" high.
- Screws included.
- Available in Bright Brass, Satin Nickel and Aged Bronze.



PRIVACY DOOR LATCH

- Easy to install for enhanced room privacy.
- Affixes to the door jamb, and when flipped prevents the door from opening.
- Available in Satin Chrome, Bright Chrome, Satin Nickel, Oil Rubbed Bronze, Brass.
- Measures 1-1/2" x 2-3/16".





DOORS | 1-3/8 | SUITE INTERIORS



3PEK
3 Panel Equal
Smooth Shaker



IPK
1 Panel
Smooth Shaker
Lincoln Park



3PCK
3 Panel Craftsman
Smooth Shaker
Winslow

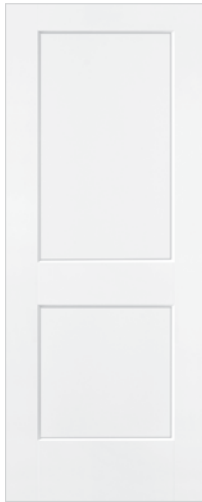

2PK
2 Panel
Smooth Shaker
Logan

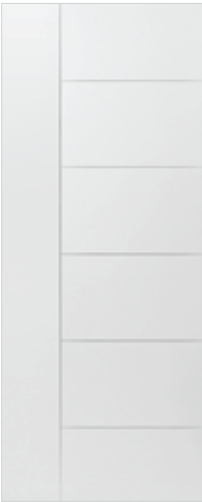

Berkley
6 Panel Equal with
1 Vertical Panel



5PSM
5 Panel Smooth
6 Panel 96"
Riverside

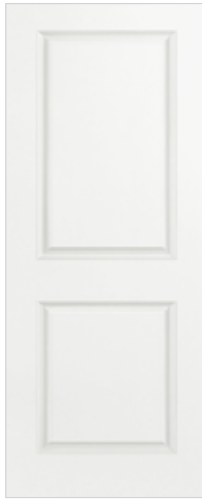

2PSM
2 Panel Smooth
Carrara

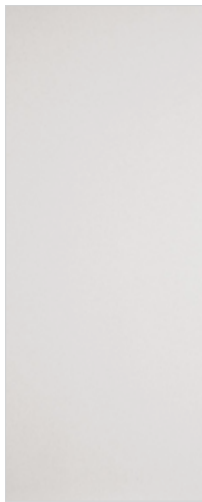

Primed Hardboard
MDF

Hollow Core

Hollow core doors are lighter and generally less expensive, but still durable and dependable.



Solid Core PBC

PBC solid core doors feature a particle board core that provides excellent sound reduction and years of dependable service.



*Warranty: 5 year limited
Construction Wood stiles, bottom rail 2" MDF to allow minimal trim.*



GLASS PANEL DOORS

Brighten any room with glass interior French Doors. Available in primed MDF engineered wood, with Clear Tempered or White Laminated glass. Can be painted to match any decor.

Door	Primed Engineered Wood
Glass	Clear Tempered, White Laminated
Door Thickness	1-3/8"
Width	24" (2/0), 28" (2/4), 30" (2/6), 32" (2/8), 36" (3/0)
Height	80" (6/8), 96" (8/0) Other sizes available upon request.

Glass Options



Clear Tempered
PR 271K CT 2/0
PR 271K CT 2/6



White Laminated
PR 271K LAM 2/0
PR 271K LAM 2/6



BARN DOORS & HARDWARE SYSTEMS



Built to last, Renin provides an extensive collection of Barn Door kits that are ideal for any room or opening in your home or office. The kits are complete with everything you need to create and hang a barn door - a pre-finished door slab, matte black bent strap hardware and matching handle.

- | | | | | | |
|--|---|---|--|---|---|
|  |  |  |  |  |  |
| Sierra Natural Pine Barn Door Kit
SIER3/0 UP BKBS
<i>Supplied unfinished. Paint or stain required.</i> | Stone K Barn Door Kit Primed White
STONE3/0 PW BKBS | Boca 1 Panel White Barn Door Kit
BOCA3/0 PW BKBS | Pavilion 5 Lite Frosted Barn Door Kit
PAV3/0 BW BKBS | Hall 3 Lite Frosted Barn Door Kit
HALL3/0 IA BKBS | Stone K Barn Door Kit Silver Oak
STONE3/0 SO BKBS |

View the complete product offering at renin.com.



URBAN DESIGN BYPASS



TWILIGHT 1-LITE | BYPASS DOOR

Full-height, frosted glass set in a Bright White frame makes the Twilight sliding bypass closet door an ideal and functional accent for any room.

- Tool-free, dial-adjust roller closet door hardware.
- Solid engineered wood is scratch-resistant, will not warp or crack.
- Pre-finished on both sides in Bright White.
- 4mm frosted tempered glass allows for filtered light.
- Cannot be painted, stained or cut.
- Custom closet door sizes are not available.

View the complete product offering at renin.com.

Frame Finishes



Bright
White

Width

Height

47-48"	80-1/4" - 80-7/8"
59-60"	80-1/4" - 80-7/8"
71-72"	80-1/4" - 80-7/8"



BYPASS DOOR



EURO 3-LITE

The European-inspired, 3-lite sliding bypass closet door system showcases frosted glass for translucent light transmission and privacy.

- Tool-free, dial-adjust roller closet door hardware.
- Durable, engineered wood sliding closet doors.
- Pre-finished in scratch-resistant Off-White on both sides.
- 4mm frosted tempered glass allows for filtered light.
- Upper roll closet door track aligns doors in place and on track, while a no-bottom track system keeps your floors damage-free and avoids tripping hazards with a clear, easy-to-clean opening.
- Cannot be painted, stained or cut.
- Custom closet door sizes are not available.

Frame Finishes



Off-White Espresso Iron Age

Width	Height
47-48"	80-1/4" - 80-7/8"
59-60"	80-1/4" - 80-7/8"
71-72"	80-1/4" - 80-7/8"



PREHUNG DOOR SYSTEMS

1-3/8" DOORS

Our door systems make remodelling easy. Factory machined doors, prehung in high-quality jambs combined with 3-1/2" ball bearing hinges, in your choice of 6 finishes.

Ready to Install

- Lock prep for hassle-free hardware installation.
- Primed pine fingerjoint jamb, or Primed MDF.

Hinge Finishes



1-3/4" DOORS

Save time and labour on the job site with prehung assembled door systems. Factory machined doors, prehung in high-quality jambs, 4-1/2" x 4" ball bearing or self-closing hinges.

Ready to Install

- Primed fingerjoint pine with or without kerf.
- Optional 20 Minute Fire Label affixed to frame.
- Optional Door Viewer preparation, Viewer sold separately.

PINE JAMB SETS | 1-3/8 DOORS

PINE FLAT JAMB C/W STOP

- Jamb packs ship complete with jamb, stop and a set of three 3-1/2" hinges in the finish if your choice.
- Available in 4-9/16", 6-9/16", 4-13/16", 6-13/16" widths.

ROUGH OPENING

WIDTH = Door with plus 2" | **HEIGHT** = Door height plus 1-1/4"



Flat Jamb and Stop

FINGER-JOINT PINE 1-3/8" RABBETED JAMB

- Jamb packs ship complete with jamb, stop and a set of three 3-1/2" hinges in the finish if your choice.
- Available in right handing or left handing only.
- Consider pre-hung unit for ease of install.
- Available in 4-9/16" width.

ROUGH OPENING

WIDTH = Door with plus 2" | **HEIGHT** = Door height plus 1-1/4"



Finger-joint Rabbeted Jamb

DRYWALL JAMB SETS | 1-3/8 DOORS

S SERIES DRYWALL KNOCK DOWN FRAMES - HOLLOW METAL

Note: S Series frames are for use with 1-3/8" door thickness. Available on project based requests.

- Interior multi-family, hotel use (bathrooms, closets)
- Sold with 3-1/2" hinges square.
- Available with drilling height of 40" OC or 44" OC from top of door.

Specifications

- 18 gauge A40 Galvaneal Steel (passivated for easy paint application)

ROUGH OPENING

WIDTH = Door with plus 2" | **HEIGHT** = Door height plus 1-1/4"

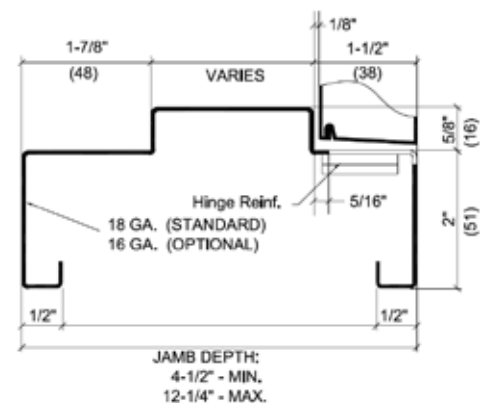



POCKET DOOR HARDWARE

JOHNSON POCKET 1500



Suitable for 1-3/8" doors up to 125 lbs each. 1-3/4" requires adapter kit.

This series is designed to carry heavy standard size doors in 2 x 4 timber or steel framed stud walls. It is versatile and can be adapted for use in non-standard wall thicknesses, block masonry walls, and can be cut down to accept any smaller size door.

CROWDER TYPE C POCKET



Suitable for doors to 150 lbs.

This series provides easier and quicker installation than a traditional pocket door frame built on site thanks to its quick release hanger.

- Can be installed in single door or double bi-parting door applications
- Use with CP-801 Extruded Aluminum Header Track, 6061-T5 Alloy.



SLIDING DOOR HARDWARE

2610SC SOFT-CLOSE WALL MOUNT SLIDING DOOR HARDWARE



For doors weighing up to 165lbs/75kg each.

The 2610SC is a versatile and easy to install soft-closing wall mounted sliding door hardware set ideally suited where the installation of a Pocket Door is not structurally possible or cost effective. This includes closets, storage rooms or anywhere space is limited. It is for interior use only and not suited for external applications.

KRISTRACK KT47 WALL MOUNT SLIDING DOOR TRACK



From closet doors to custom room dividing door applications, KrisTrack manufactures a complete range of sliding door hardware that is sure to meet your specific needs.

KN CROWDER CCSF-493 BARN DOOR SYSTEMS



This all-in-one side mounted kit covers the track and any gap between the track and door. Equipped with our Easy Connect Hangers, this kit makes installation a breeze. Nylon wheels with precision ball bearings always make for smooth and quiet door operation. For added convenience, an optional snap-on fascia and end caps are available to streamline the installation process and finishing work.



BARN TRACK HARDWARE

CHOICE OF: TOP OF DOOR OR BENT STRAP

Barn Door kit includes hangers, track, dampers and hanging hardware for one barn door weighing up to 250lbs.

OPTIONAL:

Bi-part Synchronized Hardware
Single Track Bypass



DEBEN HANDLE SN



DEBEN HANDLE MB



ALPERTON HANDLE SN



ALPERTON HANDLE MB

Handle sold separately.



BYPASS DOOR HARDWARE

JOHNSON 1166 BYPASS TRACK & HARDWARE



An economical pre-finished gold colored steel bypass track with convex track rails, which provide one point contact between wheel and track. One wheel (7/8" dia.) hangers with three point locking. One inch high woodtone adjustable door guide. Brass-tone steel parts.

KRISTRACK KT50 BYPASS



From closet doors to custom room dividing door applications, KrisTrack manufactures a complete range of sliding bypass door hardware that is sure to meet your specific needs.

CROWDER C400 BYPASS



For Single & Bi-Parting, Bypassing, Pocket or Wall Mounted Doors.

This series provides the ultimate in smooth sliding door track performance. Eight ball bearing, nylon tire wheels per door. Features vertical adjustment by threaded door top plate and locknut. Ideal for mirror covered and solid core doors.

The track comes standard in a mill finish, and the optional snap-on fascia in a Clear Anodized finish. Custom finishes, such as Black Anodized or Powder-Coated, are also available.

RECTANGULAR POCKET DOOR MORTISE LOCKS

EMTEK.

The Modern Rectangular Pocket Door Mortise Lock offers a clean, contemporary trim style and high-quality lock for your sliding interior doors. This item is a well-crafted mortise lock with an integrated push button activated edge pull, and is offered in keyed, privacy, passage or dummy applications.



- Sold as complete set.
- Includes screws and strike plate.
- Must specify door thickness for Keyed and Privacy functions.
- Plates are 1/16" thick.

POCKET DOOR LATCHING HARDWARE

IVES.



POCKETPASS SQ_

- For 1-3/8" Door thickness.
- Privacy, Passage.
- Packaged with fasteners.
- Finish options: Black (622), Satin Nickel (619).

Dimensions: 1-3/4" x 2-1/4"



JOHNSON PRIV 1-3/8_
JOHNSON DUMMY_



- For 1-3/8" Door thickness.
- Privacy, Passage.
- Packaged with fasteners.
- Finish options: Black (622), Satin Nickel (619), Bright Brass (3).



- For 1-3/8" Door thickness.
- Packaged with fasteners.
- Finish options: Black (622), Satin Nickel (619), Bright Brass (3).

SLIDING & BARN DOORS | LATCHING HARDWARE



BARN DOOR PRIVACY LATCH



- For 1-3/8" Door thickness.
- Surface applied.
- Finish options: Matte Black (622).

Easy latch is compatible with most flat track barn door hardware. The locking bar mounts to the edge of the door and latches into the stop affixed to the track.



PEMKO
ASSA ABLOY



SDL SERIES

The SDL Series Privacy Barn Door Lock is designed for surface mounted sliding doors. It is installed on the jamb wall facing the opening to offer simple comfort and privacy when needed.

- For surface mounted, side wall mounted sliding doors.
- Handing reversible in the field.
- Privacy function.
- Includes Emergency Release Key.
- For doors with 3/8"- 3/4" clearance between the wall or frame and door face.
- ADA option available.
- Doors can be prepped in the field.
- Available in Black Graphite and Polished Stainless Steel.
- Width 3-9/16" Height 1-7/8" Projection 9/16".



BACK-TO-BACK ROUND DOOR PULL & FLUSH SET

- For 1-3/8" or 1-3/4" door thickness.
- Packaged with fasteners.
- Finish options: Satin Stainless Steel (630) & Flat Black (622).

This door pull set is an excellent choice for barn doors. It includes a standout 18" round pull with 1" diameter, paired with a 15" x 2-1/4" flush pull.

ROCKWOOD
ASSA ABLOY

KN Crowder



SLIDING & BARN DOORS FLUSH & ROUND PULL



ARCHITECTURAL PULLS | RESIDENTIAL INTERIOR



MegaMet™
Effortless style in a simple design allow these pulls to offer a pleasing, functional, modern solution to any entry door.

Grip: Metal
Posts: All finishes available

RM1240 RM1270

STRAIGHT PULL | FLAT ENDS

RM1240	Diameter 1/2"	Projection 1-3/8"
RM1250	Diameter 5/8"	Projection 1-1/2"
RM3320	Diameter 1"	Projection 2-3/4"
RM3321	Diameter 1-1/4"	Projection 3"
RM3322	Diameter 1-1/2"	Projection 3-1/4"

OPTIONAL OFFSET PULL | FLAT ENDS

RM1270	Diameter 5/8"	Projection 1-1/2"
RM3330	Diameter 1"	Projection 2-1/2"
RM3331	Diameter 1-1/4"	Projection 2-3/4"
RM3332	Diameter 1-1/2"	Projection 3"



NoirMet™
Make a bold statement with the subtlety of black, hard-coat anodized grips contrasted with a compelling selection of end and mounting post finishes.

Grip: Black Anodized
Posts: All finishes available

RM1410 RM1430

STRAIGHT PULL | FLAT ENDS

RM1410	Diameter 5/8"	Projection 1-1/2"
RM3800	Diameter 1"	Projection 2-3/4"
RM3810	Diameter 1-1/4"	Projection 3"
RM3820	Diameter 1-1/2"	Projection 3-1/4"

OFFSET PULL | FLAT ENDS

RM1430	Diameter 5/8"	Projection 1-1/2"
RM3830	Diameter 1"	Projection 2-1/2"
RM3840	Diameter 1-1/4"	Projection 2-3/4"
RM3850	Diameter 1-1/2"	Projection 3"



TAYMOR BATH COLLECTION

Bring the look and experience of your bathroom design to life with this comprehensive portfolio of bath hardware.

Taymor®



YATES



ULTRA



ROBSON



INFINITY



Renin has a complete selection of Mirrors with Medicine Cabinets, and Mirrors with LED lights, available in a large selection of shapes and sizes.



Medicine Cabinets provide extra storage to any bathroom. Available in recessed, semi-recessed, or surface mount.

DIVISION 8 - FINISHINGS



Rubbermaid

Rubbermaid carries the standard for high quality steel epoxy coated wire shelving. Durable and reliable, it has become the norm in most new homes and home renovations. White or Satin Nickel finish.



MOULDINGS

We source from a variety of Canadian Vendors to provide high quality mouldings to suit your products needs.





PLAZA RESTAURANT

PLAZA Z

FLY

RESTAURANT



TEA BOX

ABC OUTFIT

LM HOME

THE ROSE

ABC OUTFIT

THE ROSE

Industry Associations



CONTACT

For Service & Installation, please call or email:

1-888-871-3667
service@pennerdoors.com

For orders and quick service please email:

orders@pennerdoors.com

For project estimates please email:

estimating@pennerdoors.com

  @pennerdoors.com