

Pocket doors-
Flush pulls/
Maniglie
per incasso

K 1186

design Valli Workshop

Material Brass/Materiale Ottone





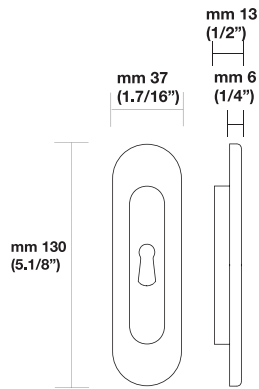



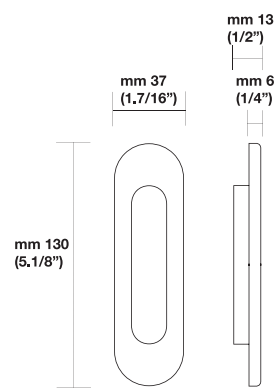

K 1186











K 1186 SFC



K 1186 Key hole

Finish	Size	Retail price
 03	mm 130x37x13 [5.1/8"x1.7/16"x1/2"]	\$ 59.00
 03D	mm 130x37x13 [5.1/8"x1.7/16"x1/2"]	\$ 59.00
 06A	mm 130x37x13 [5.1/8"x1.7/16"x1/2"]	\$ 62.00
 06B	mm 130x37x13 [5.1/8"x1.7/16"x1/2"]	\$ 59.00
 15	mm 130x37x13 [5.1/8"x1.7/16"x1/2"]	\$ 74.00
 26	mm 130x37x13 [5.1/8"x1.7/16"x1/2"]	\$ 59.00
 26D	mm 130x37x13 [5.1/8"x1.7/16"x1/2"]	\$ 62.00
 Natural brass	mm 130x37x13 [5.1/8"x1.7/16"x1/2"]	\$ 59.00

K 1186 SFC without key hole

Finish	Size	Retail price
 03	mm 130x37x13 [5.1/8"x1.7/16"x1/2"]	\$ 59.00
 03D	mm 130x37x13 [5.1/8"x1.7/16"x1/2"]	\$ 59.00
 06A	mm 130x37x13 [5.1/8"x1.7/16"x1/2"]	\$ 62.00
 06B	mm 130x37x13 [5.1/8"x1.7/16"x1/2"]	\$ 59.00
 15	mm 130x37x13 [5.1/8"x1.7/16"x1/2"]	\$ 74.00
 26	mm 130x37x13 [5.1/8"x1.7/16"x1/2"]	\$ 59.00
 26D	mm 130x37x13 [5.1/8"x1.7/16"x1/2"]	\$ 62.00
 Natural brass	mm 130x37x13 [5.1/8"x1.7/16"x1/2"]	\$ 59.00

K 1195 Serie Bess

design Yoshimi Kono

Material Brass/Materiale Ottone



ASSA ABLOY

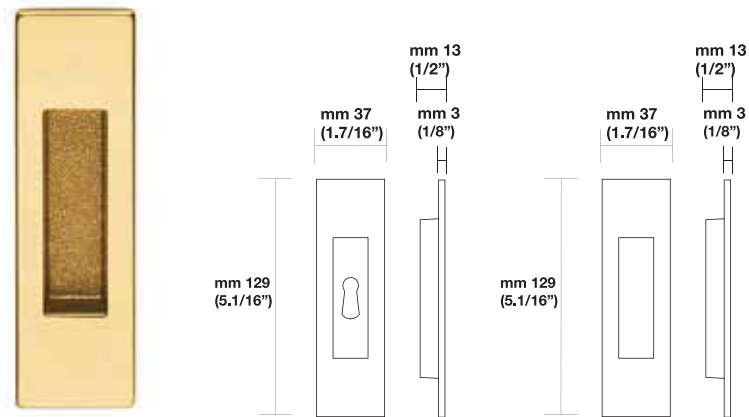

K 1195 Key hole

Finish	Size	Retail price
26	mm 129x37x13 [5.1/16"x1.7/16"x1/2"]	\$ 65.00
26D	mm 129x37x13 [5.1/16"x1.7/16"x1/2"]	\$ 68.00

K 1195 SFC without key hole

Finish	Size	Retail price
26	mm 129x37x13 [5.1/16"x1.7/16"x1/2"]	\$ 65.00
26D	mm 129x37x13 [5.1/16"x1.7/16"x1/2"]	\$ 68.00

K 1200 Serie Trittico

design Valli Workshop

Material Brass/Materiale Ottone

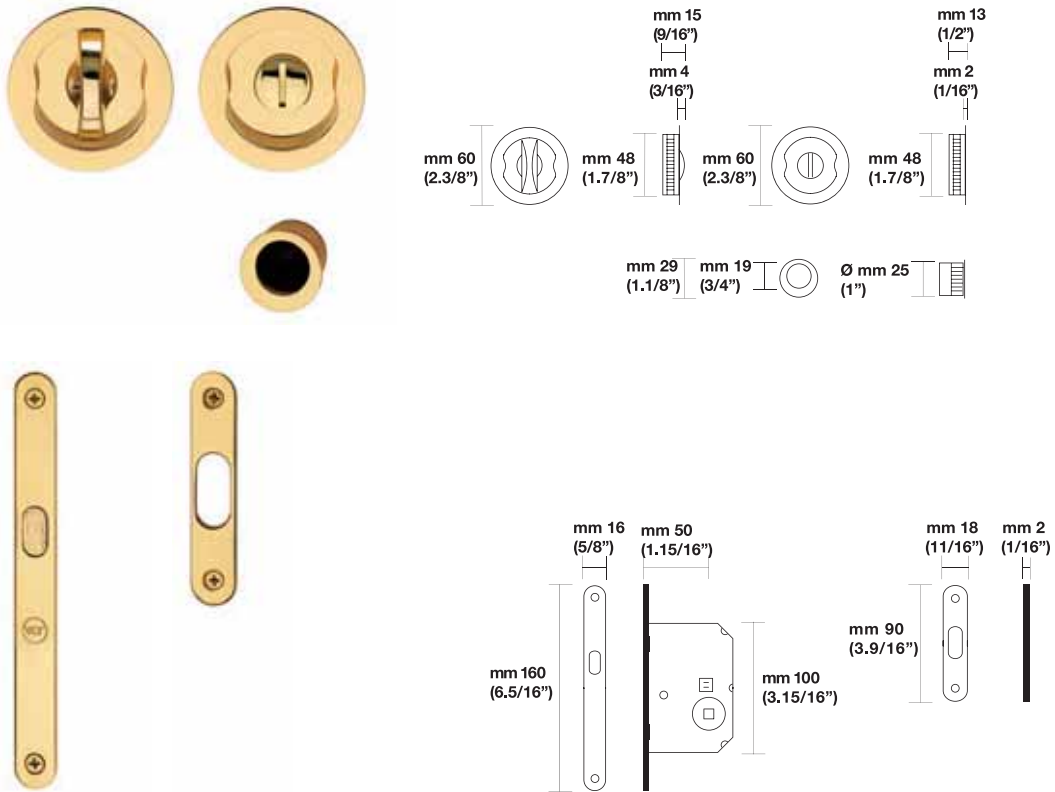

K 1200 Privacy

Retail price

Finish	Size	1.3/4"
03	mm 60x15x13 [2.3/8"x9/16"x1/2"]	\$ 195.00
03D	mm 60x15x13 [2.3/8"x9/16"x1/2"]	\$ 195.00
06A	mm 60x15x13 [2.3/8"x9/16"x1/2"]	\$ 195.00
06B	mm 60x15x13 [2.3/8"x9/16"x1/2"]	\$ 195.00
26	mm 60x15x13 [2.3/8"x9/16"x1/2"]	\$ 214.00
26D	mm 60x15x13 [2.3/8"x9/16"x1/2"]	\$ 214.00
Natural brass	mm 60x15x13 [2.3/8"x9/16"x1/2"]	\$ 213.00

NOTE

Privacy flush pulls accommodate 1.3/4" thickness only.

Pocket door kit with thumb turn complete with lock and recessed finger pull.

K 1200 = Pocket door thumb turn do not flush complete.

Split finishes available.

Add \$150.00 list to the highest priced finish.

K 1201 Serie Trittico

design Valli Workshop

Material Brass/Materiale Ottone





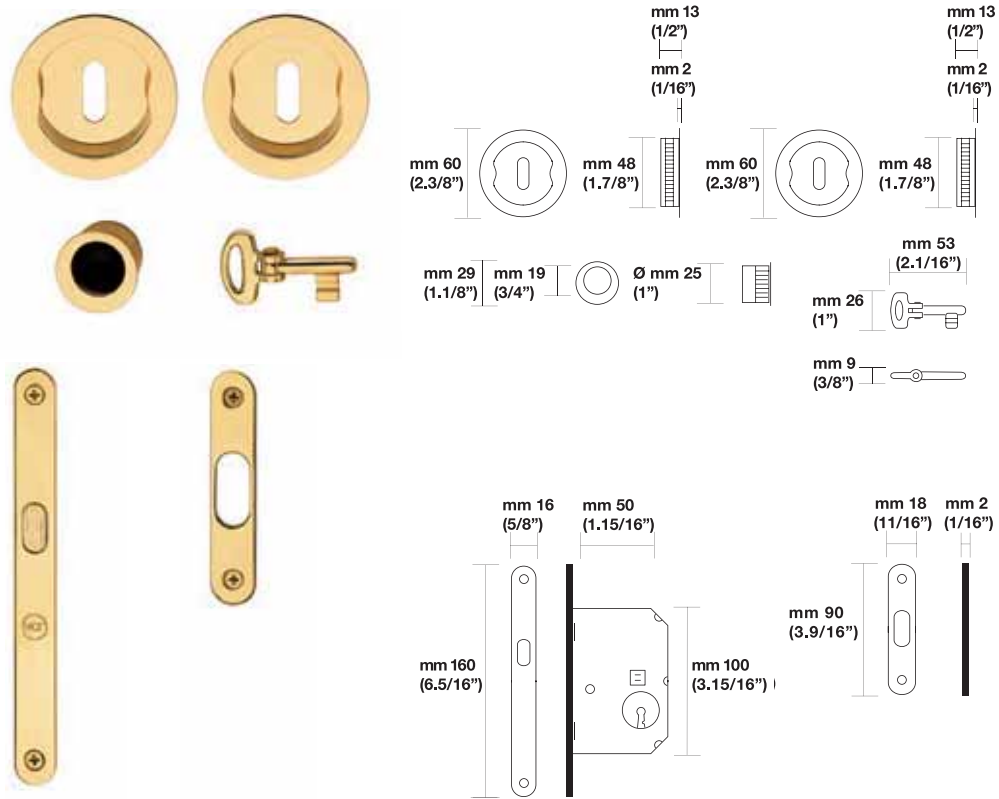

ASSA ABLOY



K 1201 Privacy

Retail price

Finish	Size	1.3/4"
 03	mm 60x48x13 [2.3/8"x1.7/8"x1/2"]	\$ 162.00
 03D	mm 60x48x13 [2.3/8"x1.7/8"x1/2"]	\$ 162.00
 06A	mm 60x48x13 [2.3/8"x1.7/8"x1/2"]	\$ 162.00
 26	mm 60x48x13 [2.3/8"x1.7/8"x1/2"]	\$ 179.00
 26D	mm 60x48x13 [2.3/8"x1.7/8"x1/2"]	\$ 179.00

NOTE

Privacy flush pulls accommodate 1.3/4" thickness only.

Pocket door kit with thumb turn complete with lock and recessed finger pull.

Split finishes available.

Add \$150.00 list to the highest priced finish.

Conversions from metric to U.S. measurements are approximate.

K 1202 Serie Trittico

design Valli Workshop

Material Brass/Materiale Ottone

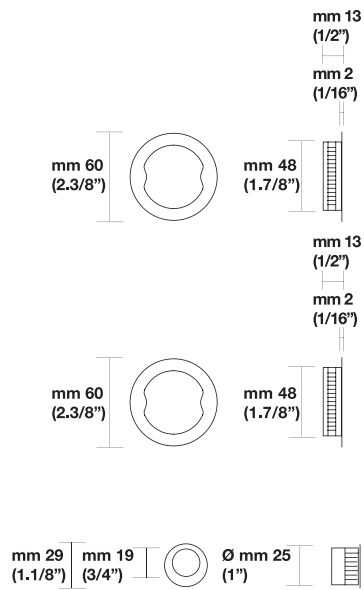

K 1202



Finish	Size	Retail price
03	mm 60x48x13 [2.3/8"x1.7/8"x1/2"]	\$ 97.00
03D	mm 60x48x13 [2.3/8"x1.7/8"x1/2"]	\$ 97.00
06A	mm 60x48x13 [2.3/8"x1.7/8"x1/2"]	\$ 97.00
06B	mm 60x48x13 [2.3/8"x1.7/8"x1/2"]	\$ 97.00
26	mm 60x48x13 [2.3/8"x1.7/8"x1/2"]	\$ 108.00
26D	mm 60x48x13 [2.3/8"x1.7/8"x1/2"]	\$ 108.00

NOTE

Flush pulls accommodate 1.3/8" and 1.3/4" door thickness.
Pocket door with recessed finger pull, without lock.
 Split finishes available.
 Add \$150.00 list to the highest priced finish.

K 1203 Serie Trittico

design Valli Workshop





Material Brass/Materiale Ottone



ASSA ABLOY



K 1203

	Finish	Ø Diameter	Retail price
	03	mm 25 [1"]	\$ 24.00
	03D	mm 25 [1"]	\$ 24.00
	06A	mm 25 [1"]	\$ 24.00
	26	mm 25 [1"]	\$ 26.00
	26D	mm 25 [1"]	\$ 26.00

NOTE

Recessed finger pull.

Conversions from metric to U.S. measurements are approximate.

K 1204 Serie Tancredi

design Valli Workshop

Material Brass/Materiale Ottone

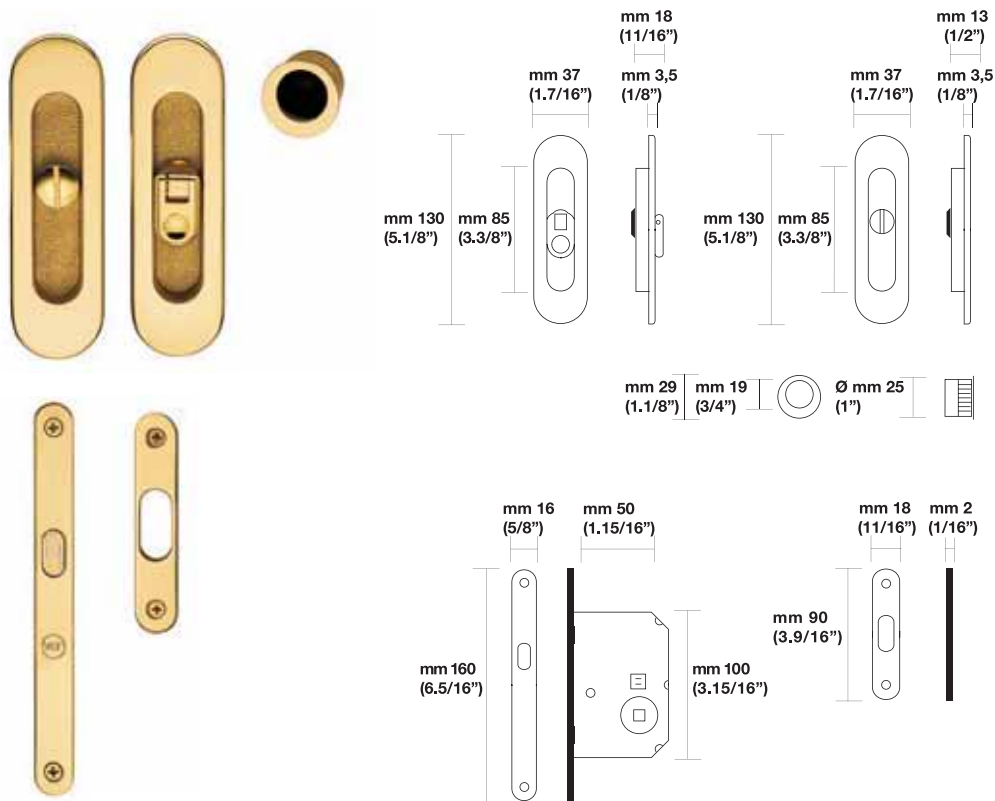

K 1204 Privacy

Retail price

Finish	Size	1.3/4"
03	mm 130x37x18 [5.1/8"x1.7/16"x11/16"]	\$ 202.00
03D	mm 130x37x18 [5.1/8"x1.7/16"x11/16"]	\$ 202.00
06A	mm 130x37x18 [5.1/8"x1.7/16"x11/16"]	\$ 202.00
26	mm 130x37x18 [5.1/8"x1.7/16"x11/16"]	\$ 223.00
26D	mm 130x37x18 [5.1/8"x1.7/16"x11/16"]	\$ 223.00

NOTE

Privacy flush pulls accommodate 1.3/4" thickness only.
7/32 Thumbturn protrudes from surface plate.

Pocket door kit with thumbturn complete with lock and recessed finger pull.
K 1204 = Pocket door thumbturn do not flush complete.

Split finishes available.

Add \$150.00 list to the highest priced finish.

K 1205 Serie Tancredi

design Valli Workshop





Material Brass/Materiale Ottone

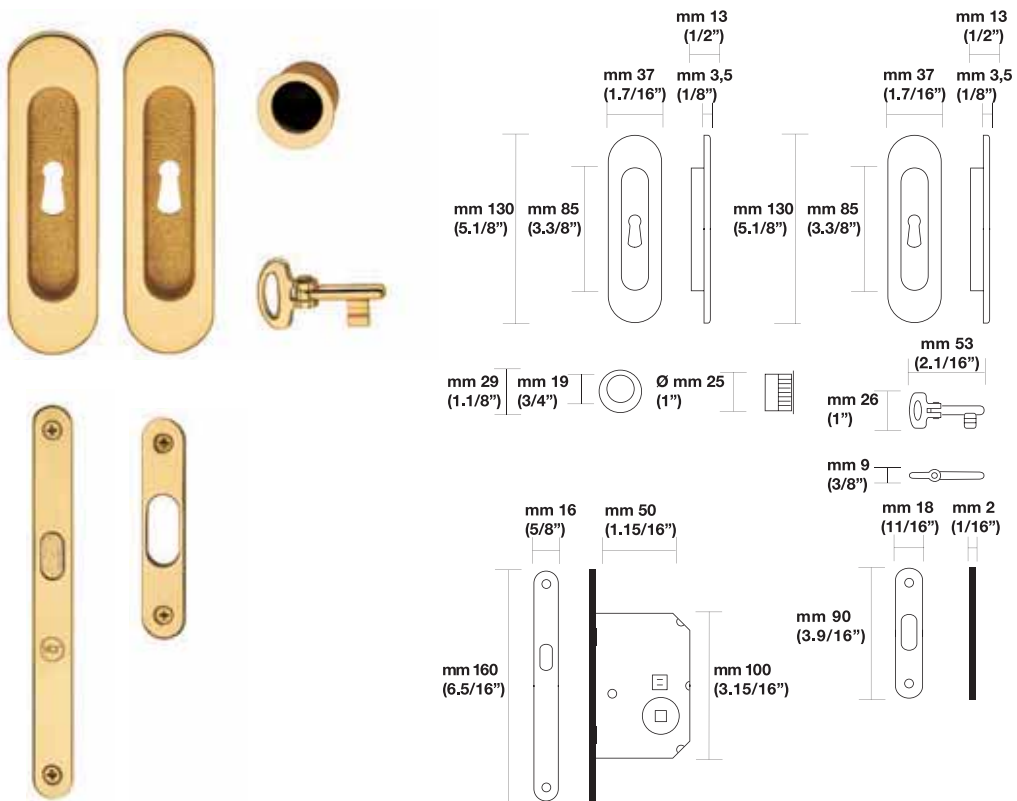

ASSA ABLOY



K 1205 Privacy

Finish	Size	Retail price
		1.3/4"
	03 mm 130x37x13 [5.1/8"x1.7/16"x1/2"]	\$ 174.00
	03D mm 130x37x13 [5.1/8"x1.7/16"x1/2"]	\$ 174.00
	06A mm 130x37x13 [5.1/8"x1.7/16"x1/2"]	\$ 174.00
	26 mm 130x37x13 [5.1/8"x1.7/16"x1/2"]	\$ 186.00
	26D mm 130x37x13 [5.1/8"x1.7/16"x1/2"]	\$ 186.00

NOTE

Privacy flush pulls accommodate 1.3/4" thickness only.

Pocket door kit with thumbturn complete with lock and recessed finger pull.

Split finishes available.

Add \$150.00 list to the highest priced finish.

Conversions from metric to U.S. measurements are approximate.

K 1206 Serie Tancredi

design Valli Workshop

Material Brass/Materiale Ottone

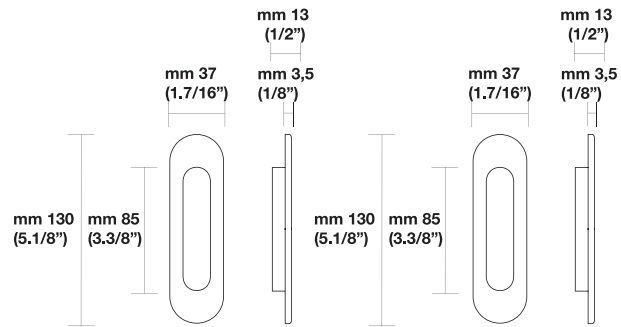

K 1206



Finish	Size	Retail price
03	mm 130x37x13 [5.1/8"x1.7/16"x1/2"]	\$ 121.00
03D	mm 130x37x13 [5.1/8"x1.7/16"x1/2"]	\$ 121.00
06A	mm 130x37x13 [5.1/8"x1.7/16"x1/2"]	\$ 121.00
26	mm 130x37x13 [5.1/8"x1.7/16"x1/2"]	\$ 133.00
26D	mm 130x37x13 [5.1/8"x1.7/16"x1/2"]	\$ 133.00

NOTE

Flush pulls accommodate 1.3/8" and 1.3/4" door thickness.
Pocket door with recessed finger pull, without lock.
 Split finishes available.
 Add \$150.00 list to the highest priced finish.

K 1211 Serie Orfeide

design Scigno

Material Brass/Materiale Ottone



ASSA ABLOY

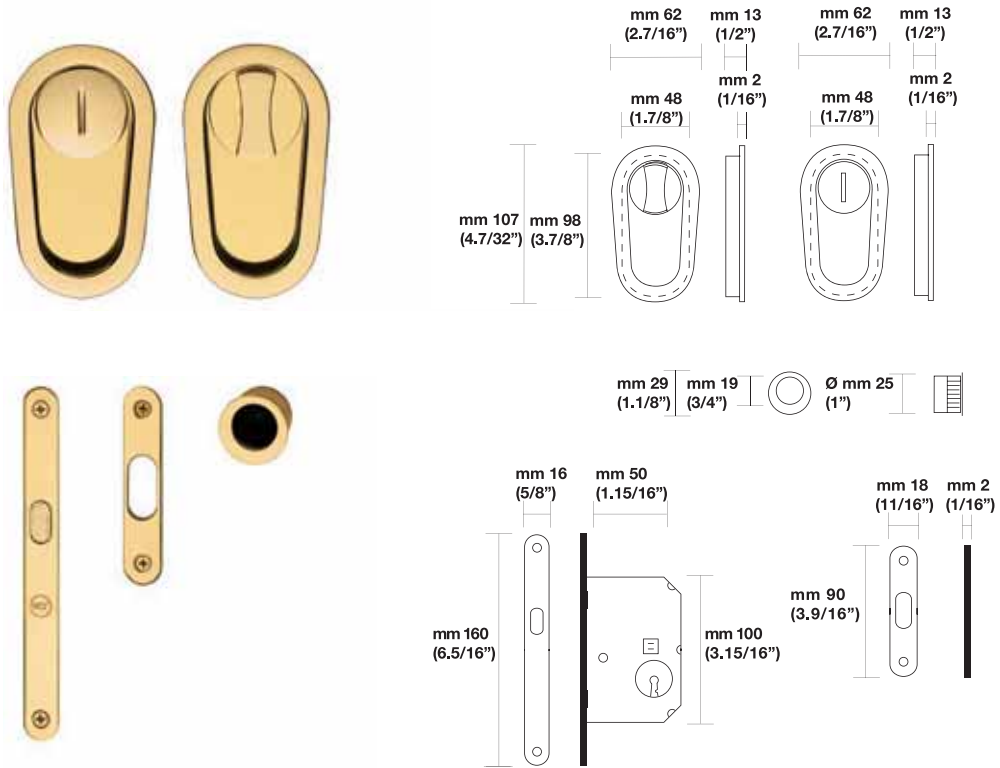

K 1211 Privacy



Finish	Size	Retail price	
		1.3/4"	1.3/8"
03	mm 107x62x13 [4.7/32"x2.7/16"x1/2"]	\$ 297.00	\$ 359.00
14	mm 107x62x13 [4.7/32"x2.7/16"x1/2"]	\$ 339.00	\$ 410.00
15	mm 107x62x13 [4.7/32"x2.7/16"x1/2"]	\$ 323.00	\$ 385.00
26	mm 107x62x13 [4.7/32"x2.7/16"x1/2"]	\$ 308.00	\$ 359.00
26D	mm 107x62x13 [4.7/32"x2.7/16"x1/2"]	\$ 308.00	\$ 359.00

NOTE

Privacy flush pulls accommodate 1.3/4" and 1.3/8" thickness. Please specify door thickness.
 1.3/8" = require minimum pocket width 2.1/16" spacer will add 1/8" to surface of both sides of the door.
Pocket door kit with thumbturn complete with lock and recessed finger pull.
 Split finishes available.
 Add \$150.00 list to the highest priced finish.

Conversions from metric to U.S. measurements are approximate.



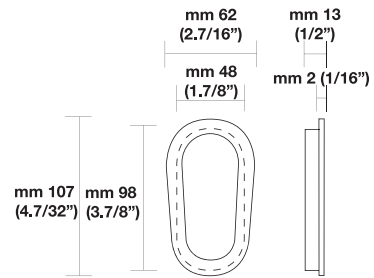
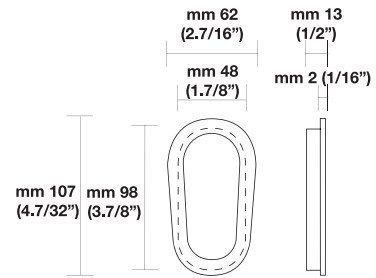

K 1212 Serie Orfeide

design Scigno

Material Brass/Materiale Ottone



K 1212

Finish	Size	Retail price
 03	mm 107x62x13 [4.7/32"x2.7/16"x1/2"]	\$ 173.00
 14	mm 107x62x13 [4.7/32"x2.7/16"x1/2"]	\$ 217.00
 15	mm 107x62x13 [4.7/32"x2.7/16"x1/2"]	\$ 198.00
 26	mm 107x62x13 [4.7/32"x2.7/16"x1/2"]	\$ 190.00
 26D	mm 107x62x13 [4.7/32"x2.7/16"x1/2"]	\$ 182.00

NOTE

Flush pulls accommodate 1.3/8" and 1.3/4" door thickness.
Pocket door with recessed finger pull, without lock.
 Split finishes available.
 Add \$150.00 list to the highest priced finish.

K 1230 Serie Bess

design Yoshimi Kono





Material Brass/Materiale Ottone

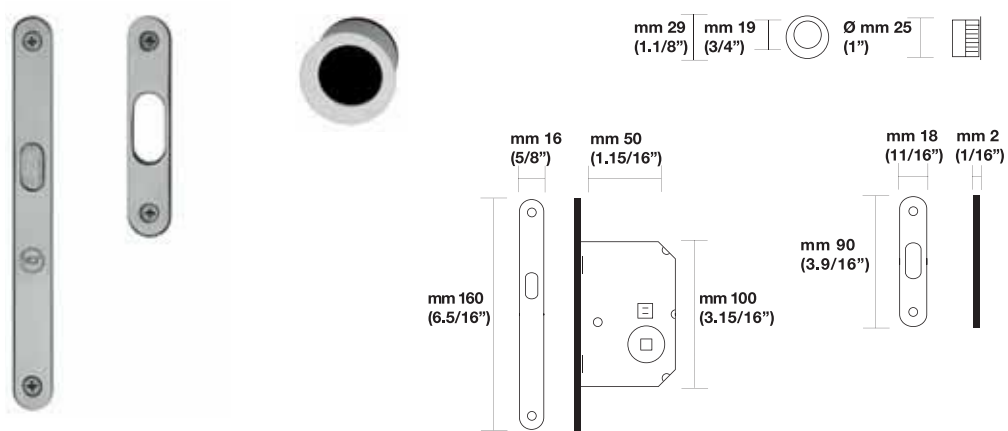
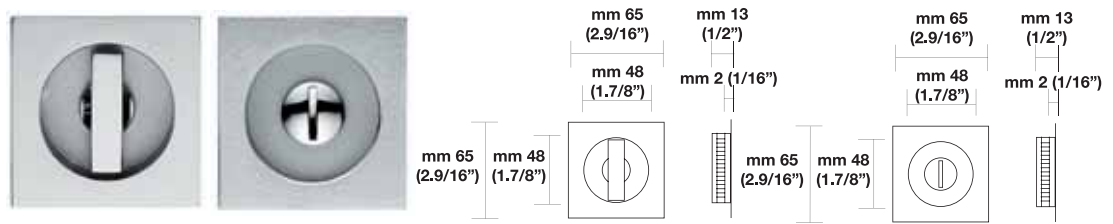

ASSA ABLOY



K 1230 Privacy

Finish	Size	Retail price		
		1.3/4"	1.3/8"	
	14	mm 65x65x13 [2.9/16"x2.9/16"x1/2"]	\$ 287.00	\$ 333.00
	15	mm 65x65x13 [2.9/16"x2.9/16"x1/2"]	\$ 287.00	\$ 333.00
	26	mm 65x65x13 [2.9/16"x2.9/16"x1/2"]	\$ 251.00	\$ 291.00
	26D	mm 65x65x13 [2.9/16"x2.9/16"x1/2"]	\$ 263.00	\$ 300.00

NOTE

Privacy flush pulls accommodate 1.3/4" and 1.3/8" thickness. Please specify door thickness.
1.3/8" = require minimum pocket width 2.1/16" spacer will add 1/8" to surface of both sides of the door.

Pocket door kit with thumbturn complete with lock and recessed finger pull.

Split finishes available.

Add \$150.00 list to the highest priced finish.

Conversions from metric to U.S. measurements are approximate.



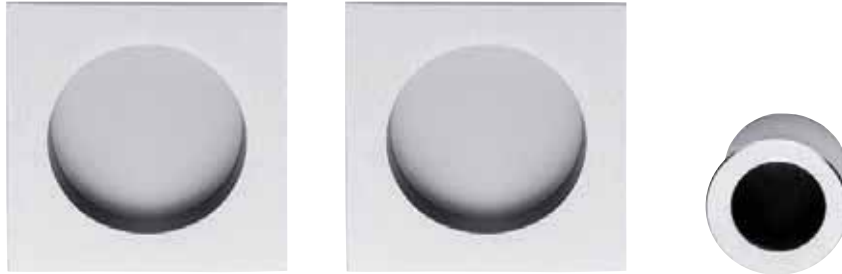

K 1232 Serie Bess

design Yoshimi Kono

Material Brass/Materiale Ottone



K1232

Finish	Size	Retail price
	14 mm 65x65x13 [2.9/16"x2.9/16"x1/2"]	\$ 145.00
	15 mm 65x65x13 [2.9/16"x2.9/16"x1/2"]	\$ 145.00
	26 mm 65x65x13 [2.9/16"x2.9/16"x1/2"]	\$ 126.00
	26D mm 65x65x13 [2.9/16"x2.9/16"x1/2"]	\$ 132.00

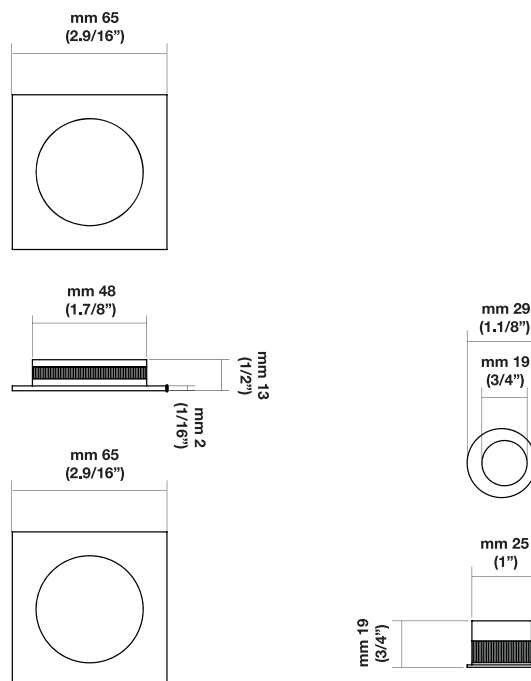

NOTE

Flush pulls accommodate 1.3/8" and 1.3/4" door thickness.

Pocket door with recessed finger pull, without lock.

Split finishes available.

Add \$150.00 list to the highest priced finish.

K 4200

Material Brass/Materiale Ottone

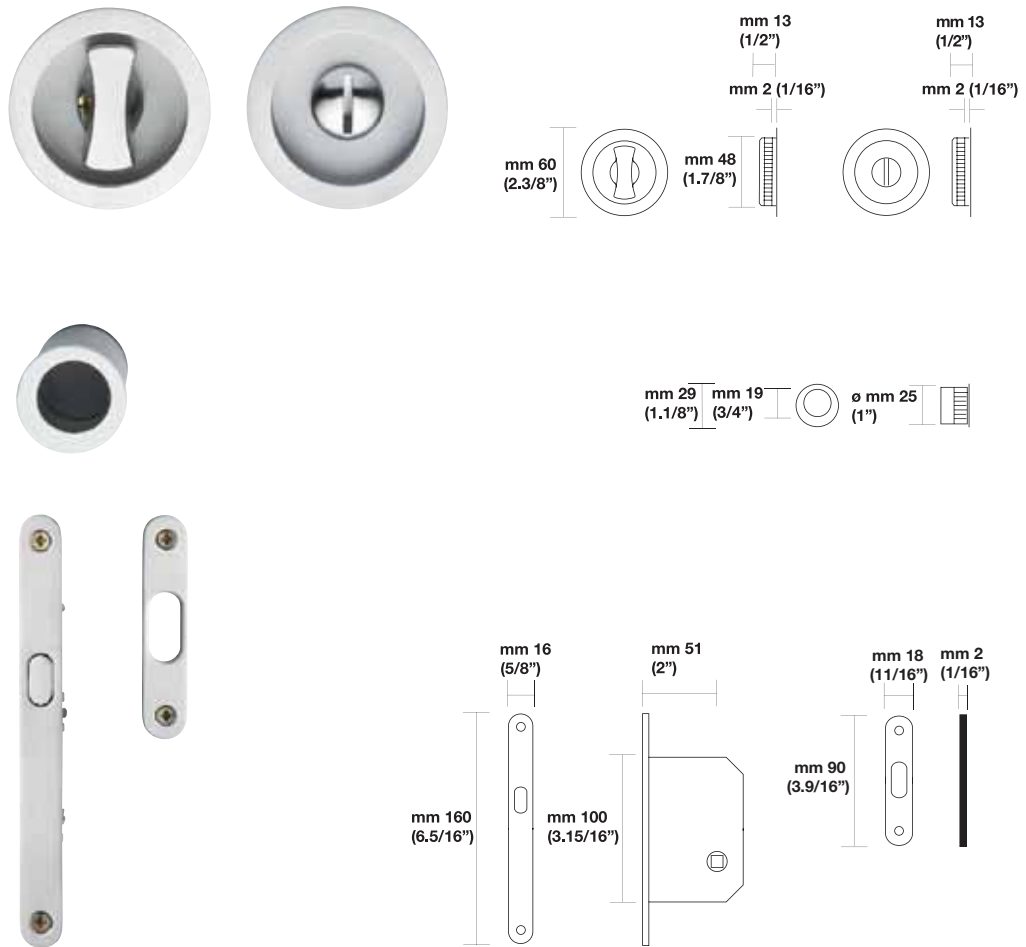

K 4200 Privacy

Retail price

Finish	Diameter ϕ	Size	Retail price	
			1.3/4"	1.3/8"
03	mm 25 [1"]	mm 60x48x13 [2.3/8"x1.7/8"x1/2"]	\$ 101.00	\$215.00
26	mm 25 [1"]	mm 60x48x13 [2.3/8"x1.7/8"x1/2"]	\$ 112.00	\$240.00
26D	mm 25 [1"]	mm 60x48x13 [2.3/8"x1.7/8"x1/2"]	\$ 112.00	\$245.00

NOTE

Privacy flush pulls accommodate 1.3/4" and 1.3/8" thickness. Please specify door thickness.
 1.3/8" = required minimum pocket width 2.1/16" spacer will add 1/8" to surface of both sides of the door.
Pocket door kit with thumbturn complete with lock and recessed finger pull.
 Split finishes available.
 Add \$150.00 list to the highest priced finish.

Conversions from metric to U.S. measurements are approximate.

K 4202

Material Brass/Materiale Ottone

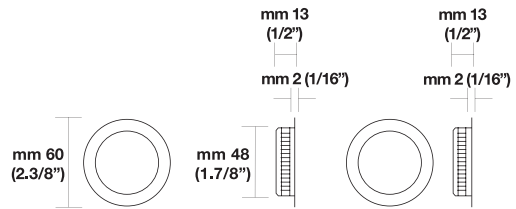

K 4202



Finish	Diameter ϕ	Size	Retail price
03	mm 25 [1"]	mm 60x48x13 [2.3/8"x1.7/8"x1/2"]	\$ 53.00
26	mm 25 [1"]	mm 60x48x13 [2.3/8"x1.7/8"x1/2"]	\$ 59.00
26D	mm 25 [1"]	mm 60x48x13 [2.3/8"x1.7/8"x1/2"]	\$ 59.00

NOTE

Flush pulls accommodate 1.3/8" and 1.3/4" door thickness.

Pocket door with recessed finger pull, without lock.

Split finishes available.

Add \$150.00 list to the highest priced finish.

Conversions from metric to U.S. measurements are approximate.