

M

MADERO DOORS & HARDWARE



BUILT FOR THE CANADIAN CLIMATE

EXTERIOR DOOR SYSTEMS ENTRY SERIES

20
15

M

MADERO DOORS & HARDWARE

BUILT FOR THE CANADIAN CLIMATE

No one ever really thinks about how much abuse a door takes. Madero doors consistently stand guard against the sun, the rain and extreme cold. Our doors are built to exceed what it takes to keep the weather out and look gorgeous doing it. Doors aren't something most people think about, but it's all we think about.



CONTENTS

SECTION 1 - DOOR SYSTEMS	1
Economy Door System.....	2-3
Basic Door System.....	4-5
Maverick Door System.....	6-7
Dakota Door System.....	8-9
Titan Door System.....	10-11
NEW: Titan X Door System.....	12-13
Workhorse Combo Door System.....	14-15
SECTION 2 - ADD-ONS/OPTIONS	16
Door System Add-Ons	17
Exterior Glass Options.....	18-19
SECTION 3 - SPECIFICATIONS	20
What to Know Before You Order.....	21
Steel Doors	22
Fiberglass Doors.....	23
Basic Wood Frames.....	24
Basic Composite Frames.....	25

ENTRY SERIES

SECTION

1

STANDS UP TO THE WORST CANADIAN WEATHER

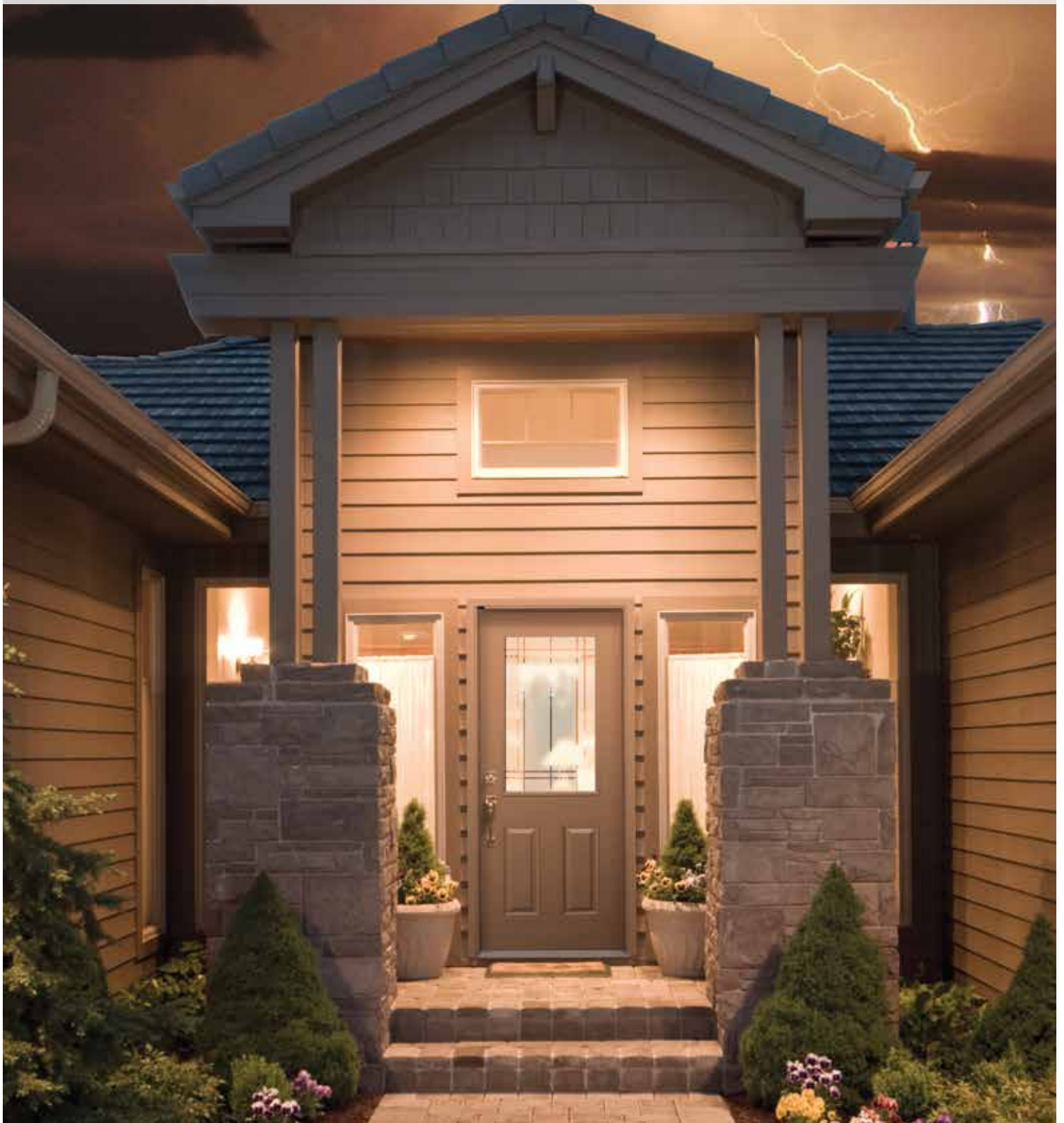

Madero

economy



EASY AND ECONOMICAL

The Economy entry level unit, designed specifically for garages and outbuildings, combines a warm white steel inswing 6 panel door with a basic wood frame.

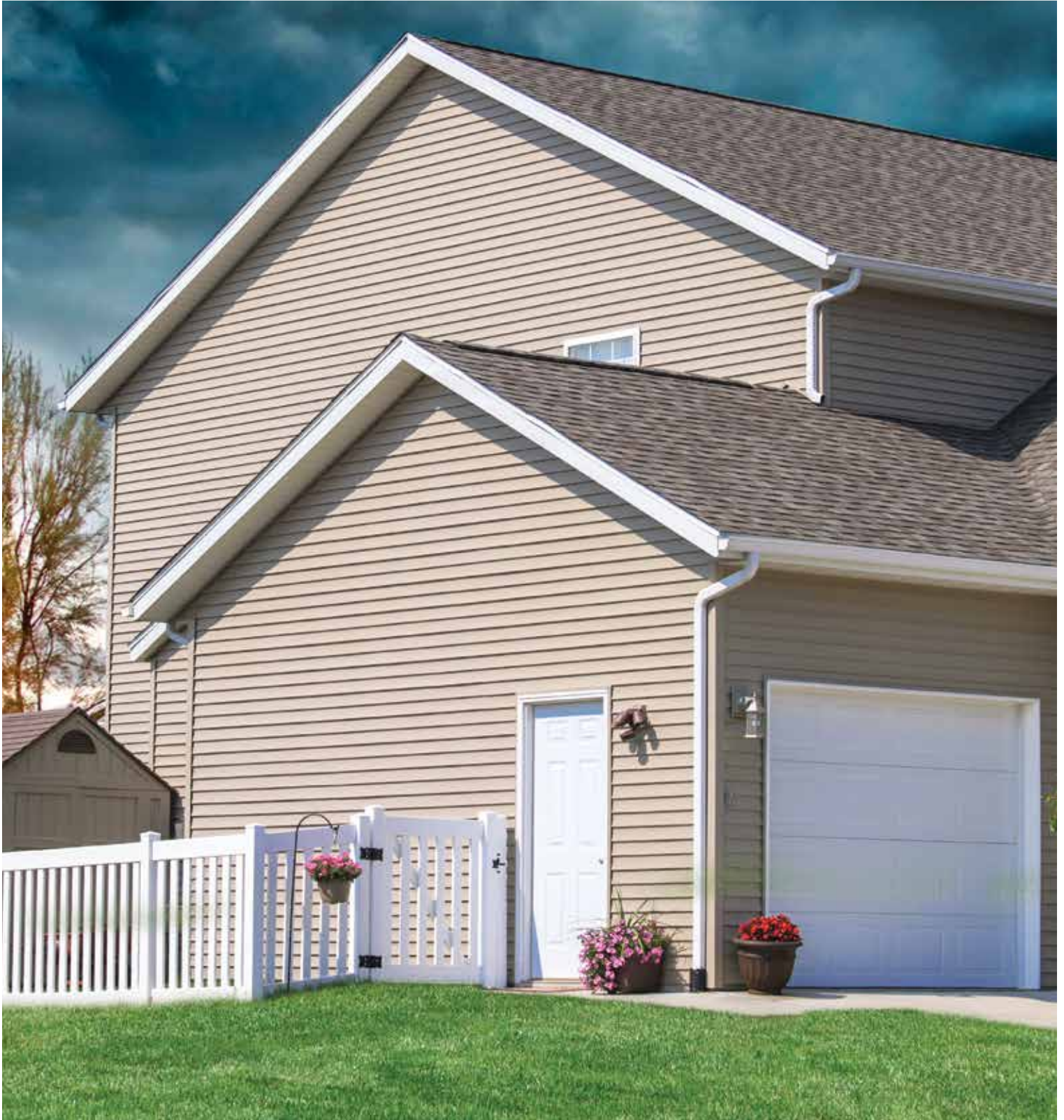

DOOR SYSTEMS



ENTRY LEVEL UNIT DESIGNED FOR GARAGES AND SHEDS.

WARM WHITE STEEL SLAB

BASIC WOOD FRAME

- DOOR** Primed, warm white, low-definition steel; primed wood stiles and top rail; composite bottom rail
- CORE** Polyurethane with 6" wood lock block
- FRAME** Kiln-dried, finger jointed primed pine; see page 24 for product details
- SIZES** Widths: 2/8 and 3/0; Height: 6/8; inswing only
- WARRANTY** 1 year limited warranty if painted within 45 days of purchase

DOOR DESIGN AVAILABLE



6 Panel only

Madero

Basic

BASIC AND AFFORDABLE

24 gauge steel combined with a basic wood frame provide an economical and steadfast entry solution. Available in a 6 panel design, sunburst, 4 lite or 10 different 22" x 36" glass options.



DOOR SYSTEMS



**actual product not painted*

Madero

Basic

OFFERING STYLE, FUNCTION AND MOST IMPORTANTLY, AFFORDABILITY.

HIGH DEFINITION STEEL SLAB

BASIC WOOD FRAME

- DOOR** 24 gauge primed high-definition steel, bright white; primed wood stiles and top rail; composite bottom rail
- DRILL** Single or double drill available
- CORE** Polyurethane with 10" wood lock block
- FRAME** Kiln-dried, finger jointed primed pine; see page 24 for product details
- SIZES** Widths: 2/8, 2/10 and 3/0; Height: 6/8; inswing and outswing available
- ADD-ONS** See page 17
- WARRANTY** 5 year limited warranty if painted within 45 days of purchase

DOOR DESIGNS AVAILABLE



6 Panel



Vent
Raise & Lower



Pear



9 Lite Internal



Mini-Blinds
Raise, Lower & Tilt



4 Lite External



1 Lite
Dual or Dual Low E



Sunburst
External



Nouveau



Estate



Bristol



Simplicity

Madero
MAVERICK

COST EFFICIENT AND VERSATILE

Suitable for residential applications, outbuildings or garage needs, the Maverick brings you the benefits of fiberglass in a cost-efficient 6 panel door with the versatility of 12 glass options.



DOOR SYSTEMS



*actual product not painted

BENEFITS OF FIBERGLASS
PRE-PIGMENTED WHITE
STEEL REINFORCED
TEMPERATE TO THE TOUCH
DOESNT ABSORB MOISTURE
PAINT NOT REQUIRED

Madero
MAVERICK

THE BENEFITS OF A FIBERGLASS DOOR,
WITH AFFORDABILITY AT TOP OF MIND.

SMOOTH WHITE FIBERGLASS SLAB

BASIC WOOD FRAME

- DOOR** Smooth, pre-pigmented white fiberglass with composite stiles and rails
- DRILL** Single or double drill available
- CORE** Polyurethane with steel reinforced full length wood lock block
- FRAME** Kiln-dried, finger jointed primed pine; see page 24 for product details
- SIZES** Widths: 2/8, 2/10 and 3/0; Height: 6/8; inswing and outswing available
- ADD-ONS** See page 17
- WARRANTY** 25 year limited warranty on door slab - no painting required; 5 year limited warranty on components

DOOR DESIGNS AVAILABLE



6 Panel



Vent
Raise & Lower



Pear



9 Lite Internal



Mini-Blinds
Raise, Lower & Tilt



4 Lite External



1 Lite
Dual or Dual Low E



Sunburst
External



Nouveau



Estate



Bristol



Simplicity

Madero
DAKOTA

STRENGTH AND SECURITY

A composite maintenance-free frame paired with a high definition, bright white steel slab provides a long-lasting system at an affordable price.



DOOR SYSTEMS



**actual product not painted*

Madero
DAKOTA

BUILT STRONG, BUILT BEAUTIFULLY.

HIGH DEFINITION STEEL SLAB

BASIC COMPOSITE FRAME

- DOOR** 24 gauge primed high-definition steel, bright white; primed wood stiles and top rail; composite bottom rail
- DRILL** Single or double drill available
- CORE** Polyurethane with 10" wood lock block
- FRAME** Maintenance-free, smooth white composite; see page 25 for product details
- SIZES** Widths: 2/8, 2/10 and 3/0; Height: 6/8; inswing and outswing available
- ADD-ONS** See page 17
- WARRANTY** 5 year limited warranty on door slab if painted within 45 days of purchase; 5 year limited warranty on frame and components - no painting required

DOOR DESIGNS AVAILABLE



6 Panel



Vent
Raise & Lower



Pear



9 Lite Internal



Mini-Blinds
Raise, Lower & Tilt



4 Lite External



1 Lite
Dual or Dual Low E



Sunburst
External



Nouveau



Estate



Bristol



Simplicity

Madero

TITAN

MAINTENANCE FREE, LASTING DURABILITY

Provides the best in strength and security with a maintenance-free design.
Built specifically to withstand the harsh Canadian climate.

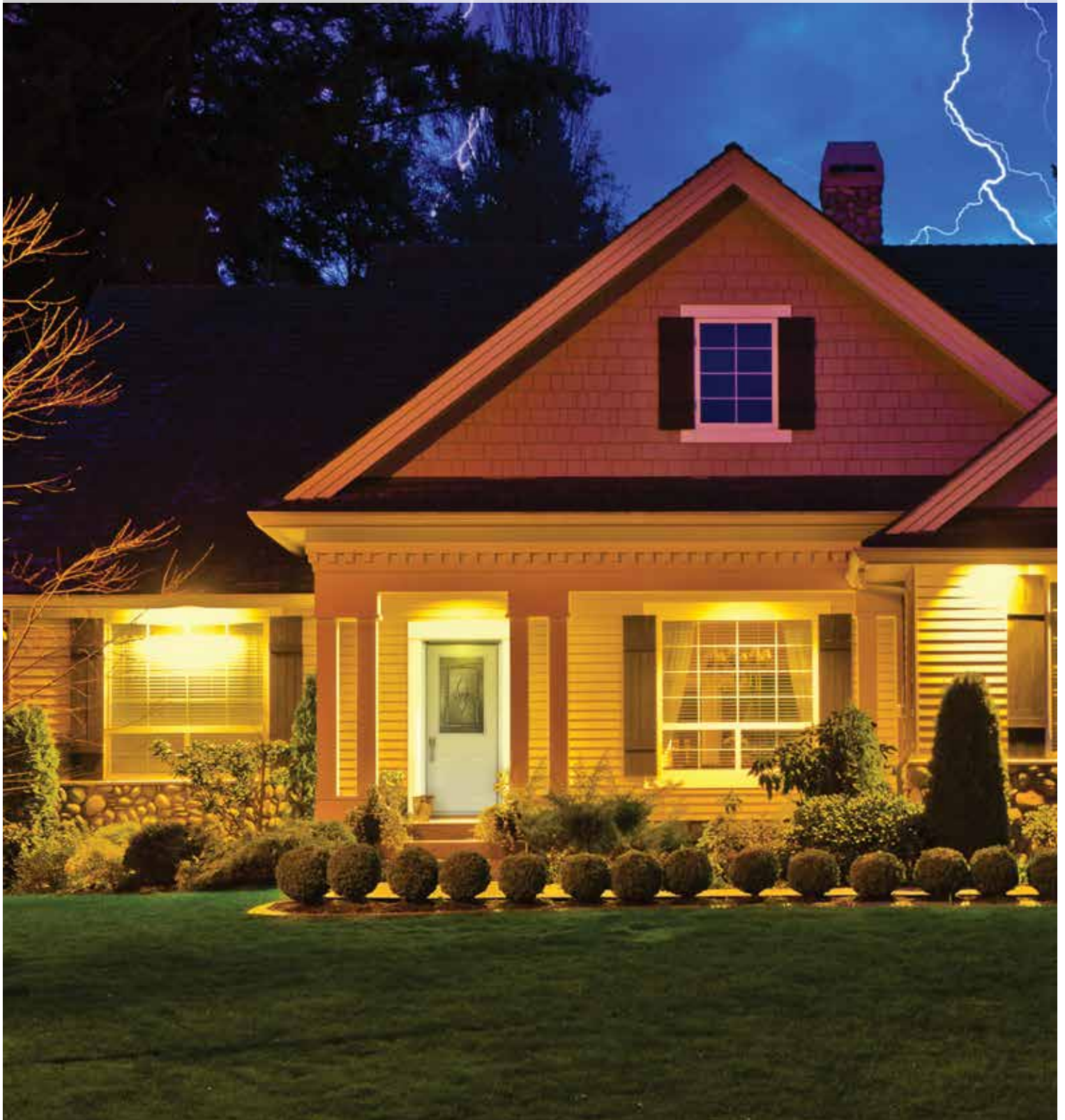

DOOR SYSTEMS



**actual product not painted*

BENEFITS OF FIBERGLASS
PRE-PIGMENTED WHITE
STEEL REINFORCED
TEMPERATE TO THE TOUCH
DOESN'T ABSORB MOISTURE
PAINT NOT REQUIRED

Madero
TITAN

THE LEGEND OF OUR ENTRY SERIES.

SMOOTH WHITE FIBERGLASS SLAB

BASIC COMPOSITE FRAME

- DOOR** Smooth, pre-pigmented white fiberglass with composite stiles and rails
- DRILL** Single or double drill available
- CORE** Polyurethane with steel reinforced full length wood lock block
- FRAME** Maintenance-free, smooth white composite; see page 25 for product details
- SIZES** Widths: 2/8, 2/10 and 3/0; Height: 6/8; inswing and outswing available
- ADD-ONS** See page 17
- WARRANTY** 25 year limited warranty on door slab and frame, 5 year limited warranty on components, no painting required

DOOR DESIGNS AVAILABLE



6 Panel



Vent
Raise & Lower



Pear



9 Lite Internal



Mini-Blinds
Raise, Lower & Tilt



4 Lite External



1 Lite
Dual or Dual Low E



Sunburst
External



Nouveau



Estate



Bristol



Simplicity

Madero

TITAN 

ANOTHER LAYER OF DEPTH TO THE TITAN LINE

The legendary Titan Series now comes with a beautiful wood grain texture throughout the door and frame. Good looks and great performance come together in this package.



DOOR SYSTEMS



BENEFITS OF FIBERGLASS
PRE-PIGMENTED WHITE
STEEL REINFORCED
TEMPERATE TO THE TOUCH
DOESN'T ABSORB MOISTURE
PAINT NOT REQUIRED

**images shown are for illustrative purposes only, actual product may vary slightly*



THE LEGEND OF OUR ENTRY SERIES, WITH A RICH TEXTURED FINISH.

WHITE WOODGRAIN FIBERGLASS SLAB

WHITE WOODGRAIN COMPOSITE FRAME

DOOR	Textured, pre-pigmented white fiberglass with composite stiles and rails
DRILL	Single or double drill available
CORE	Polyurethane with steel reinforced full length wood lock block
FRAME	Maintenance-free, textured white composite; see page 25 for product details
SIZES	Widths: 2/8, 2/10 and 3/0; Height: 6/8; inswing and outswing available
ADD-ONS	See page 17
WARRANTY	25 year limited warranty on door slab and frame, 5 year limited warranty on components, no painting required

DOOR DESIGNS AVAILABLE



6 Panel



Vent
Raise & Lower



Pear



9 Lite Internal



Mini-Blinds
Raise, Lower & Tilt



4 Lite External



1 Lite
Dual or Dual Low E



Nouveau



Estate



Bristol



Simplicity

Madero

**Workhorse
COMBO**

WORKS AS HARD AS YOU DO

The ultimate door for residential retrofit and industrial barns, providing protection from the elements and unwanted visitors.

Madero

**PLUS
Workhorse
COMBO**



DOOR SYSTEMS

Madero
Workhorse
COMBO

SECURITY, INCREDIBLE
THERMAL EFFICIENCY
AND STRENGTH.

Madero PLUS
Workhorse
COMBO

THE WORK ETHIC OF THE
WORKHORSE WITH THE
BENEFITS OF FIBERGLASS.

HIGH DEFINITION STEEL SLABS

SMOOTH WHITE FIBERGLASS SLABS

RABBETED WOOD FRAME

RABBETED WOOD FRAME

DOOR DESIGNS AVAILABLE

OUTER



Half Vent
Dual Clear

INNER



6 panel



- DOORS - WH** 24 gauge primed high-definition steel, bright white; must be painted within 45 days of purchase
- DOORS - WH PLUS** Smooth, pre-pigmented white fiberglass with composite stiles and rails; no painting required
- DRILL** Single or double drill available
- FRAME** Kiln-dried, finger jointed primed pine; see page 24 for product details
- SIZES** Widths: 2/8, 2/10 and 3/0; Height: 6/8
- ADD-ONS** See page 17
- SWING** See chart at right (four options)
- WARRANTY** 25 year limited warranty on fiberglass slab; 1 year limited warranty (must be painted and installed as per Madero instructions) on steel slab and wood frame; 5 year limited warranty on components

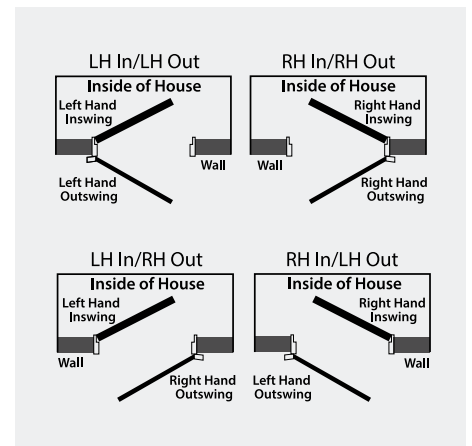

ADD-ONS / OPTIONS

MAKE IT UNIQUE, MAKE IT YOURS

SECTION

2



ADD-ONS / OPTIONS

CUSTOMIZE YOUR DOOR (will affect pricing)

Madero's Entry Series door systems have been developed to meet the needs of both residential and commercial environments. Ordered from factory, the add-ons shown below further enhance the door systems for use in your home, garage, shed, or outbuilding.



Commercial Sill

Low profile access provides an uninterrupted entry line, allowing ease of mobility for lawnmowers, wheelchairs, dollies, etc. Ideal for high traffic areas. Standard sweep not recommended.

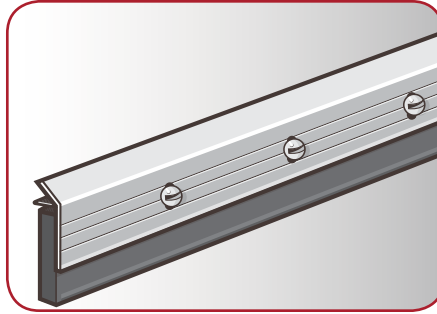

Commercial Sweep

Designed for use in conjunction with the commercial sill.

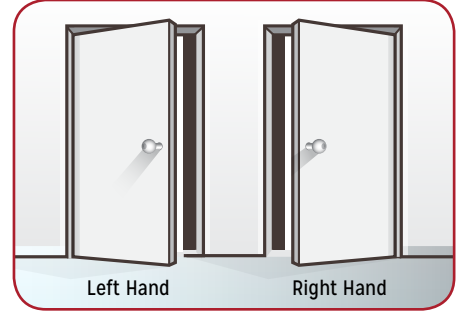

Outswing

The door will swing away from the home, as opposed to swinging into the home.

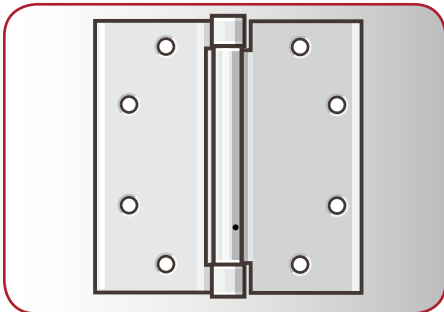

Self-Closing Hinges

These hinges are placed in the bottom and middle hinge pockets to ensure the door remains closed when not in use. Tension is to be adjusted on site.

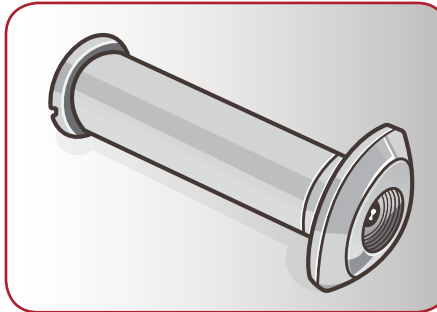

Door Viewer

Allows sight through the door. Cannot be used with any half lite glass options.

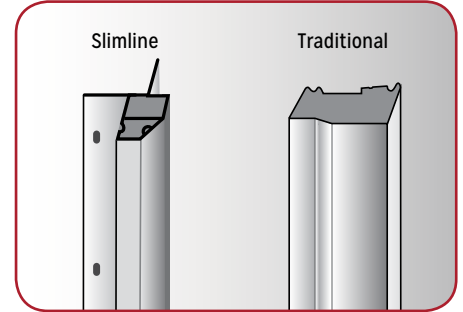

PH5900 Slimline Brickmould

A smart alternative to traditional rolled metal clad brickmould. Comes with nailing fin.

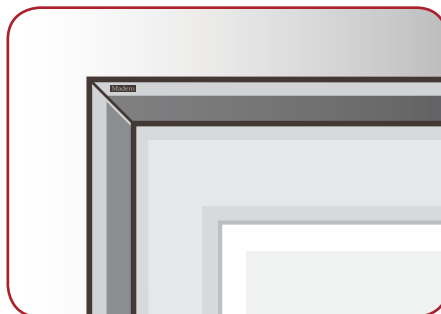

No Brickmould

All door designs are available without brickmould.



ADD-ONS / OPTIONS

A SIMPLE UPGRADE

Madero's Doorglass Inserts provide an easy do-it-yourself project and are a great way to enhance the beauty of your home's entry system. Choose from several different glass options, all of which can be installed into an industry standard 23" x 37" half-lite cut out.

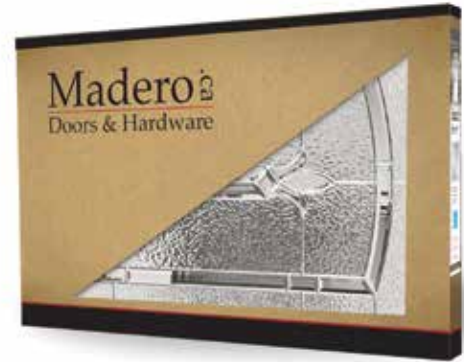

1 Lite
 • Dual clear or Dual Low-E glass



Pear
 • Stylized textured glass
 • Privacy rating: 9



9 Lite Internal
 • Clear glass with 5/8" internal grille
 • Privacy rating: 1



Mini-blinds
 • Clear glass
 • Raise, lower & tilt
 • Privacy rating: 1/5/10



Mark-12 Vent
 • Clear glass with removable screen
 • Privacy rating: 1



Nouveau
 • Clear cluster, bevel and glue chip glass
 • Privacy rating: 6

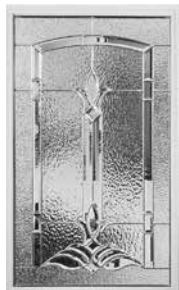

Bristol
 • Clear bevel, granite and hammered glass
 • Privacy rating: 7



Simplicity
 • Frosted and grooved glass
 • Privacy rating: 8



Estate
 • Clear bevel, soft wave, Renaissance glass
 • Privacy rating: 5

Madero's Doorglass Features:

- Retail packaged and UPC coded for ease of purchase and safe transport.
- Doorglass designs use handcrafted glass in a variety of textures to create dimension, depth, contrast, and privacy while allowing natural light to enter the home.
- Madero's decorative glass is sealed between two panels of tempered safety glass and insulated for air and water-tight performance.
- 20 year glass seal warranty.

What to Know Before You Buy:

- Madero's Doorglass Inserts are designed to fit into any industry standard 23" x 37" half-lite cut out.
- Perfect for new construction or renovation projects.
- Most 6 panel door designs can be cut or modified to accept these 22" x 36" inserts.
- Installation instructions available at: www.madero.ca/exteriordoorglass



SPECIFICATIONS

SECTION
3

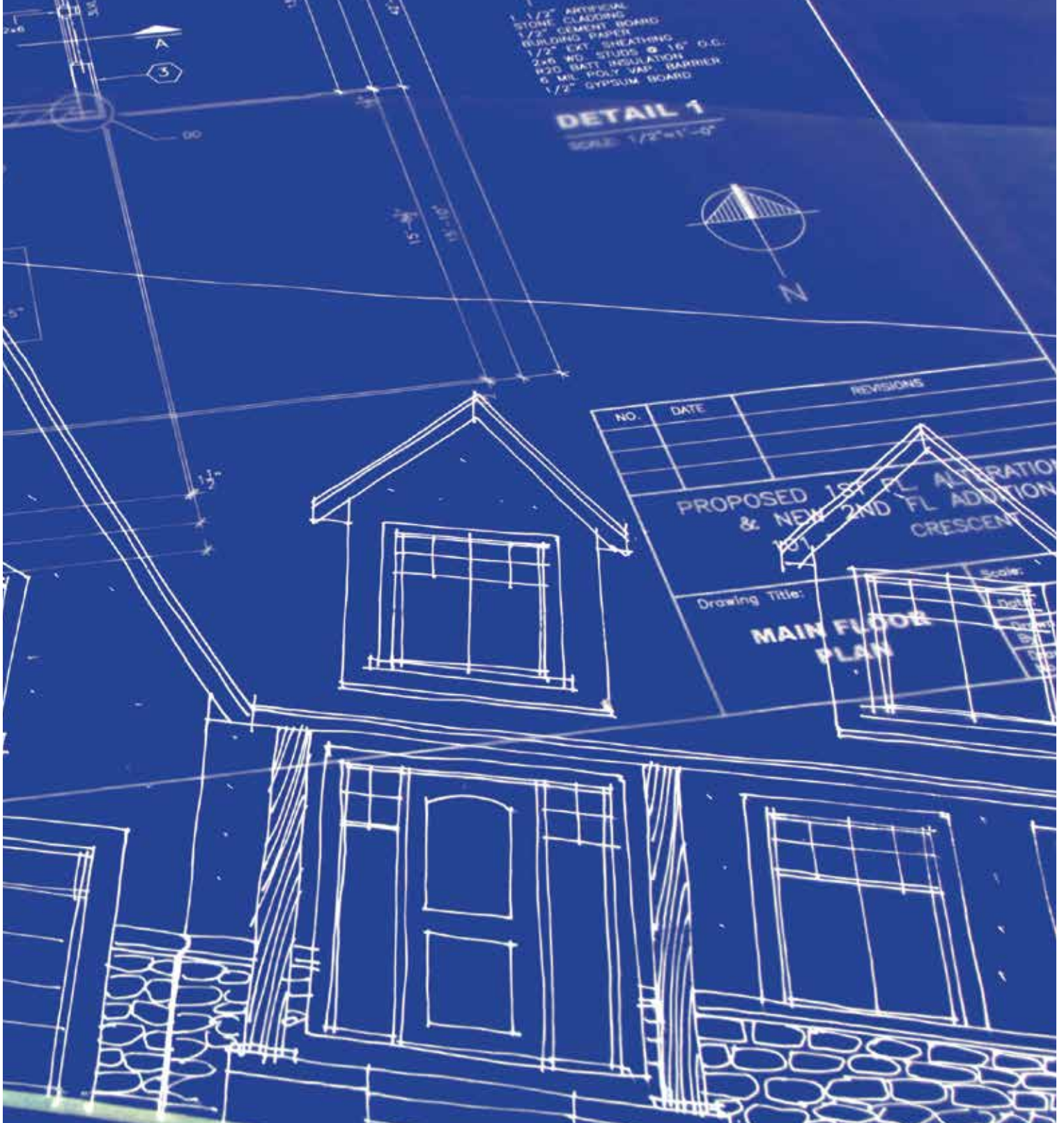

SPECIFICATIONS

WHAT TO KNOW BEFORE YOU ORDER

Renovation / New Home Construction

Available in standard 6'8" door slab heights and widths, with single or double drilling to accommodate levers, knobs, handlesets and deadbolt hardware.

PRODUCT COMPARISONS

Entry Series door systems are available in a variety of door slab and frame choices.

	Steel Slab	Fiberglass Slab	Basic Wood Frame	Basic Composite Frame
Economy*	●		●	
Basic	●		●	
Maverick		●	●	
Dakota	●			●
Titan		●		●
Titan X		●		●

*Economy door systems are available in a specialized 6 panel inswing design only

ROUGH OPENING For 6/8 height

All Entry Series doors are available in 2"x4" (4-9/16") or 2"x6" (6-9/16") construction, left hand or right hand application and inswing or outswing. Economy door systems are available as inswing applications only.

Handing from outside of building.

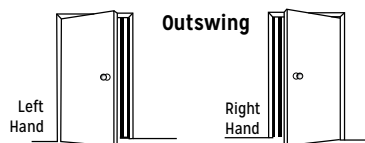
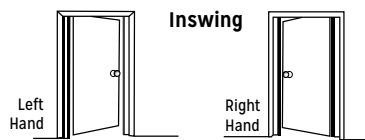

INSWING

	Slab	Net Frame	Rough Opening	OSM Brickmould
2/8 x 6/8	31 3/4" x 79"	33 7/16" x 81 5/8"	34 7/16" x 82 1/8"	35 15/16" x 82 7/8"
2/10 x 6/8	33 3/4" x 79"	35 7/16" x 81 5/8"	36 7/16" x 82 1/8"	37 15/16" x 82 7/8"
3/0 x 6/8	35 3/4" x 79"	37 7/16" x 81 5/8"	38 7/16" x 82 1/8"	39 15/16" x 82 7/8"

OUTSWING

	Slab	Net Frame	Rough Opening	OSM Brickmould
2/8 x 6/8	31 3/4" x 79"	33 7/16" x 81"	34 7/16" x 81 1/2"	36 15/16" x 82 1/4"
2/10 x 6/8	33 3/4" x 79"	35 7/16" x 81"	36 7/16" x 81 1/2"	38 15/16" x 82 1/4"
3/0 x 6/8	35 3/4" x 79"	37 7/16" x 81"	38 7/16" x 81 1/2"	40 15/16" x 82 1/4"

WORKHORSE COMBO

	Slab	Net Frame	Rough Opening	OSM Brickmould
2/8 x 6/8	31 3/4" x 79"	33 7/16" x 81 5/8"	34 7/16" x 82 1/8"	35 15/16" x 82 7/8"
2/10 x 6/8	33 3/4" x 79"	35 7/16" x 81 5/8"	36 7/16" x 82 1/8"	37 15/16" x 82 7/8"
3/0 x 6/8	35 3/4" x 79"	37 7/16" x 81 5/8"	38 7/16" x 82 1/8"	39 15/16" x 82 7/8"

WARRANTY

For Madero's complete and detailed warranty programs, please visit www.madero.ca/warranty.

SPECIFICATIONS

STEEL DOORS

Practical, Customizable, Affordable.

Madero's collection of steel entry door systems provides you with the perfect choice to suit your needs, from general use to high-end quality and appearance. Our steel door systems feature paintable primed surfaces and the strength of internal wood blocking, while our Basic and Dakota systems feature high definition embossing.

- The door skin is made with 24 gauge galvanized steel (26 gauge for Economy) with primed steel facings and primed wood edge construction.
- Designed with a 10" (or 6" for Economy) wood lock block to accommodate residential hardware.
- Available in either high definition or standard definition panel designs.
- Filled with an insulating core of 100% CFC-free polyurethane foam, providing an excellent R rating, while bonding the two door skins together.



Primed surfaces will accept an array of paint colours.

FINISHING: A primed white surface requires painting on all six sides within 45 days of date of purchase.

WARRANTY: 5 year limited warranty on door, if painted.

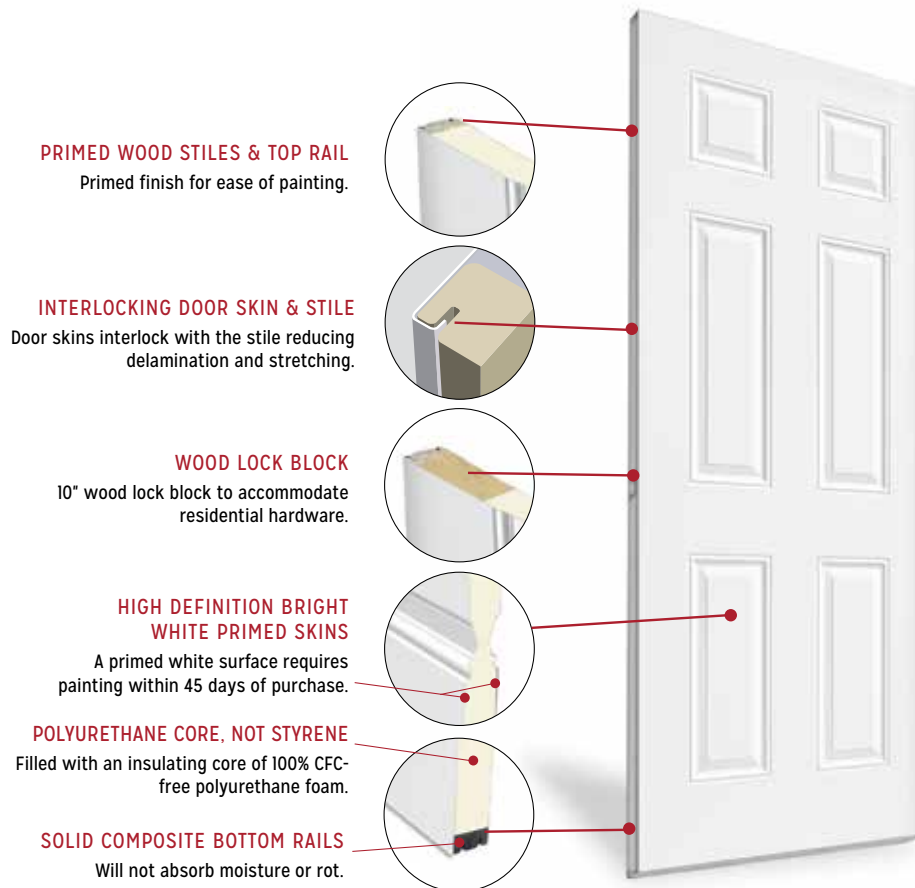

SPECIFICATIONS

FIBERGLASS DOORS

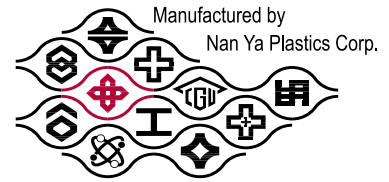

Strength, Security & Energy Efficiency

In 2005, Madero partnered with Nan Ya Plastics, a world leader in the manufacturing of fiberglass, working with the Canadian Research and Development Corporation to develop a maintenance-free door slab which meets the climate conditions found within the Canadian market.

- Smooth white pre-pigmented fiberglass does not require paint, will not discolour and withstands everyday wear and tear. Though paint is not required, these door slabs can be painted to match your home's unique design and style.
- All fiberglass door skins are made from impact-resistant fiberglass and are compression moulded to offer highly detailed panel definition.
- Door slabs are filled with an insulating core of 100% CFC-free polyurethane, providing a higher thermal efficiency than steel and offering a door slab that is temperate to the touch.
- Fiberglass doors will not dent, expand, contract, bow, warp or twist.

WATERPROOF: The stiles and rails are composed of water resistant polymer. With no exposed wood, water absorption is eliminated.

WARRANTY: 25 year limited warranty on door slab. No painting required.

EXCEPTIONAL SECURITY
Our full length steel reinforced wood lock block offers exceptional security while allowing a range of hardware mounting options.

ENERGY EFFICIENCY
Filled with an insulating core of 100% CFC-free polyurethane foam, providing an excellent R rating, while bonding the two door skins together.

STRENGTH
A steel reinforced core creates a rigid internal structure that prevents bowing and warping in extreme temperatures.

BEAUTY
Deep embossed panels create beautiful crisp lines and deep shadows that are resistant to dents, dings, splintering, and corrosion.

COMPLETELY WATERPROOF
Our full length composite stiles and rails provide complete waterproofing for the door's insulation. These stiles will not splinter like wood or delaminate like steel.

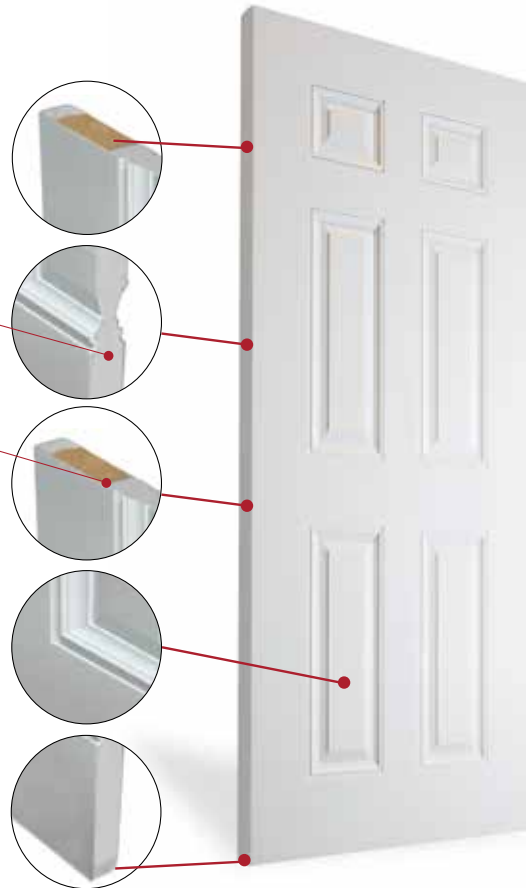

SPECIFICATIONS

BASIC WOOD FRAMES

Advanced design with the tried and true benefits of traditional wood construction.

- Kiln dried, primed finger-jointed pine
- Machine stapled for excellent holding power
- An economical and environmentally sustainable choice
- Complete with ball bearing hinges, a quality sill, a 2" brickmould and weatherstrip

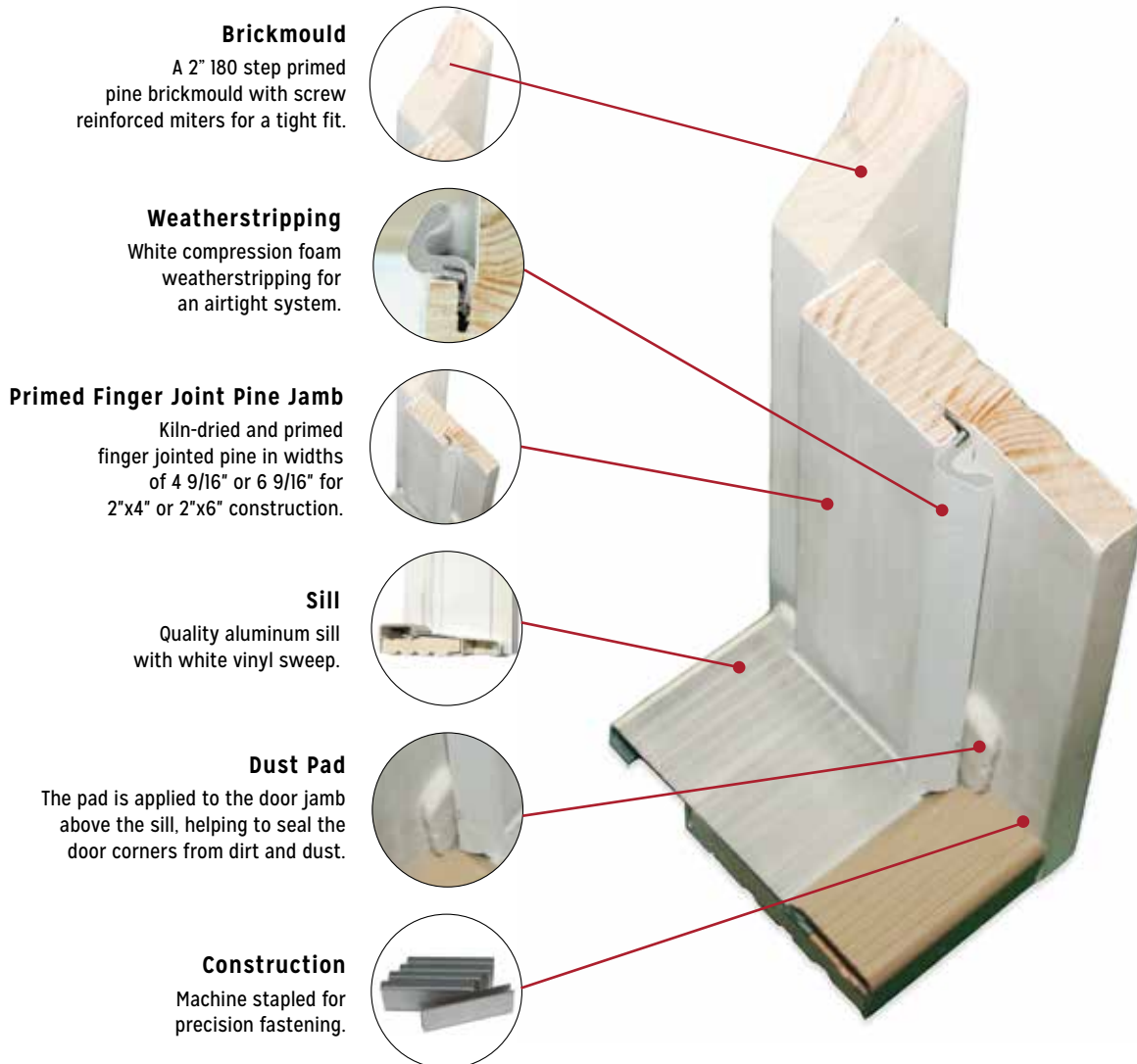

SPECIFICATIONS

BASIC COMPOSITE FRAMES

The flagship frame design for Madero's Entry Series Door Systems.

- Maintenance-free smooth white composite suited for the Canadian climate
- Pre-finished white design does not require paint
- Completely waterproof and will not discolour, absorb moisture, splinter, rust or rot
- Twice the holding power of wood
- High security, virtually indestructible and greatly reduces forced entry concerns
- Complete with ball bearing hinges, a quality sill, a 2" composite brickmould, weatherstripping and SnapLock nailing fin

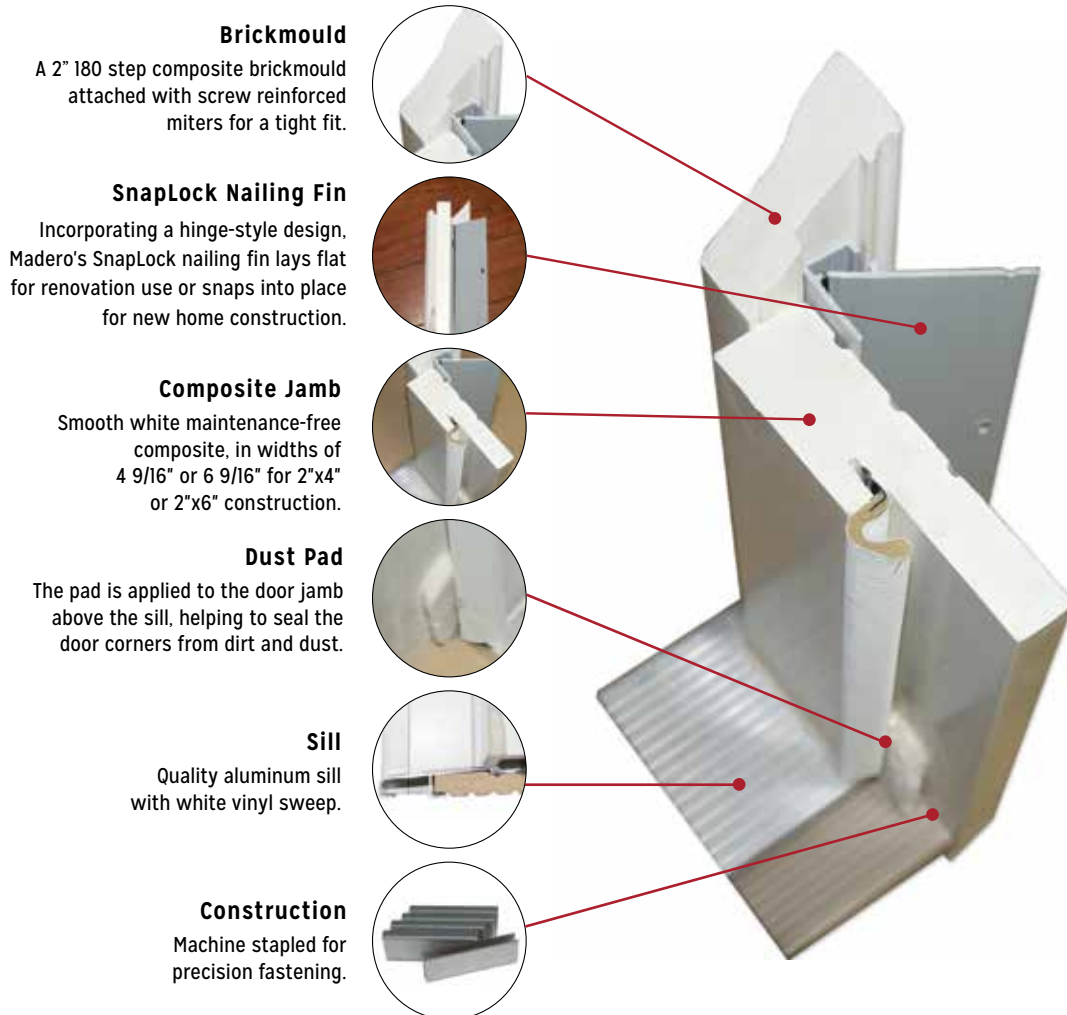

Madero^{co}
Doors & Hardware

THE BIGGER PICTURE



At Madero, we pride ourselves in understanding your needs, providing solutions and offering premium products crafted to the highest industry standards. Not only do we offer exterior doors, glass and hardware options, we also have a full line of interior and commercial products available. For more information, contact your Madero sales representative or visit our website:

www.madero.ca



Madero^{ca}

Doors & Hardware

EXTERIOR DOOR SYSTEMS | INTERIOR DOOR SYSTEMS | COMMERCIAL | HARDWARE

CALGARY

T 1.866.664.7664 • F 1.403.204.7665

SASKATOON

T 1.800.667.6977 • F 1.306.934.7644

WINNIPEG

T 1.855.706.0200 • F 1.204.594.0201

madero.ca