



# Fusital+Inox

# 15



Eero Aarnio Ron Arad Gae Aulenti Mario Bellini  
Dante O. Benini e Luca Gronzoni Cini Boeri Achille  
Castiglioni Cerri & Associati David Chipperfield  
Architects Antonio Citterio Carlo Colombo Odile  
Decq-Benoît Cornette Droog Design Ronald  
Lewerissa D'Urbino-Lomazzi Foster and Partners  
Massimiliano e Doriana Fuksas Frank O. Gehry  
Eri Goshen Michael Graves Gregotti Associati Zaha  
Hadid Jan Kleihues Hans Kollhoff Yoshimi Kono  
Leon Krier Chi Wing Lo Vico Magistretti Angelo  
Mangiarotti Richard Meier Renzo Mongiardino  
Jean Nouvel Fabio Novembre John Pawson Gustav  
Peichl Piano Design Workshop Franco Poli Andrée  
Putman Alan Ritchie-Philip Johnson Architects Aldo  
Rossi Skidmore Owings & Merrill Sottsass Associati  
Robert A.M. Stern Architects Taller Design Ricardo  
Bofill Matteo Thun Giancarlo Vegni Marco Zanuso



# Mission

The handle, as conceived by Valli&Valli, has traditionally conveyed a home's style and functional elegance and, as a decorative object therein, will remain an important element of interior décor well into the future. Guided by this vision, Valli&Valli created V&V and Fusital, trademark collections recognized for their technological sophistication and signature contemporary aesthetic.

Valli&Valli is also united by a history of strong craftsmanship and innovation, principles that have made the company a leader in the creation of solid brass, Nikrall (a zinc alloy UNI 3717) and stainless steel material handles and other household accessories that are designed to satisfy both the formal and practical requirements of the end user.

# Origins

Nearly eighty years ago, Pasquale Valli secured a position at an umbrella factory in Veduggio, Italy, managing the department that oversaw the design and production of handles. While umbrellas of the time looked exactly the same-somber, dark and gloomy-the treatment reserved for the handle itself was wildly different. In Valli's design department, fancy took flight. The handle articulated the true personality of the umbrella and it was this piece that captured a buyer's attention. The importance of touch and the contact between a consumer and an innovatively designed object was an experience that Pasquale Valli valued immeasurably.

Valli learned many things from his time in the handle department. He absorbed an understanding of the properties and handling of metal, including fusion techniques, the use of molds and dyes and the techniques employed for various other materials, such as plastics. Fascinated with the ergonomic relationship between hand and object, he was compelled to study at a sculptor's studio, inciting a passion for art and commitment to artisanal craft methods. These experiences changed his life, inspiring him to become an entrepreneur.





# Index

## FUSITAL

<b>Door levers + Window levers</b>	page 18
<b>Small Square Rosette Options</b>	page 55
<b>Handlesets</b>	page 57
<b>Door pulls</b>	page 60
<b>Pocket doors</b>	page 67

## STAINLESS STEEL

<b>Door levers</b>	page 72
<b>Door knobs</b>	page 80
<b>Door pulls</b>	page 83
<b>Mortise locks</b>	page 88
<b>Deadbolts/Privacy bolts</b>	page 98
<b>Escutcheons with deadbolts</b>	page 104
<b>Multi-Point Trims</b>	page 109
<b>Miscellaneous parts</b>	page 118
<b>Technical information</b>	page 124
<b>UNI EN ISO</b>	page 156
<b>General sales terms and conditions</b>	page 159

# Door levers/Maniglie

Material: all solid brass



**H 37** Serie Tre B  
design Cini Boeri  
page 19



**H 310<sup>1</sup>** Serie Cinque C  
design Achille Castiglioni  
page 20



**H 311** Serie Sei MB  
design Mario Bellini  
page 21



**H 315** Serie G Novanta  
design Pierluigi Cerri  
page 22



**H 317** Serie AC Novantuno  
design Antonio Citterio  
page 23



**H 326** Serie AC 1 Novantacinque  
design Antonio Citterio  
page 24



**H 327** Serie AC 2 Novantacinque  
design Antonio Citterio  
page 25



**H 329** Serie RB Novantacinque  
design Taller Design Ricardo Bofill  
page 26



**H 330** Serie T Novantasette  
design Matteo Thun  
page 27



**H 332<sup>1</sup>** Serie M Novantotto  
design Renzo Mongiardino  
page 28



**H 334** Serie NF Novantotto  
design Foster and Partners  
page 29



**H 335<sup>1</sup>** Serie RM Novantotto  
design Richard Meier  
page 30



**H 338<sup>1</sup>** Serie YK Duemila  
design Yoshimi Kono  
page 31



**H 341** Serie HK2 Duemila  
design Hans Kollhoff  
page 32



**H 343** Serie JP Duemila  
design John Pawson  
page 33



**H 344<sup>1</sup>** Serie JN Duemilauno  
design Jean Nouvel  
page 34



**H 348** Serie DC Duemiladue  
design David Chipperfield Architects  
page 35



**H 350** Serie CA Duemiladue  
design Cerri&Associati  
page 36



**H 352<sup>1</sup>** Serie ODBC Duemiladue  
design Odile Decq-Benoit Cornette  
page 37



**H 354** Serie Fog Duemilaquattro  
design Frank O. Gehry  
page 38



**H 355<sup>1</sup>** Serie Ramsa Duemilaquattro  
design Robert AM Stern Architect  
page 39



**H 356** Serie ZH Duemilacinque  
design Zaha Hadid with Woody Yao  
page 40



**H 359** Serie SOM New York Duemilasette  
design Skidmore, Owings & Merrill  
page 41



**H 361** Serie AC4 Duemilasei  
design Antonio Citterio  
page 42



**H 362** Serie CC Duemilanove  
design Carlo Colombo  
page 43



**H 363** Serie DC Duemilanove  
design David Chipperfield  
page 44



**H 364** Serie MB Duemilanove  
design Mario Bellini  
page 45



**H 367** Serie GV Duemilanove  
design Giancarlo Vegni  
page 46



**H 368** Serie CA Duemilanove  
design Studio Cerri & Associati  
page 47



**H 369<sup>1</sup>** Serie EG Duemilanove  
design Eri Goshen  
page 48

<sup>1</sup>Not currently in production. Available for minimum quantity per order/Details page 14

# Door levers/Maniglie

Material: all solid brass



**H 370** Serie MDF Duemiladieci  
design Massimiliano e Doriana Fuksas  
page 49



**H 371** Serie LK Duemiladieci  
design Leon Krier  
page 50



**H 372** Serie EG Duemiladodici  
design Eri Goshen  
page 51



**H 373** Serie DOB Duemiladodici  
design Dante O. Benini e Luca Gonzo  
page 52



**H 375** Serie Bassorilievo  
design Fusital Workshop  
page 53



**H 376** Serie Mercurio  
design Fusital Workshop  
page 54

# Handlesets

Material: all solid brass



**K 1810**  
design Valli Workshop  
page 57

# Door pulls/Maniglioni

Material: all solid brass



**K 352** Serie RM Novantotto  
design Richard Meier  
page 61



**K 353** Serie RB Novantacinque  
design Taller Design Ricardo Bofill  
page 62



**K 356** Serie JP Duemila  
design John Pawson  
page 63



**K 358** Serie CA Duemiladue  
design Cerri&Associati  
page 64



**K 359** Serie ODBC Duemiladue  
design Odile Decq-Benoit Cornette  
page 65



**K 368** Serie AC4 Duemilasei  
design Antonio Citterio/Toan Nguyen  
page 66

\*Not currently in production. Available for minimum quantity per order/Details page 14

# Pocket doors/Maniglie per incasso

Material: solid brass



## K 3012

design Antonio Citterio with Toan Nguyen  
page 68



## K 3014

design Antonio Citterio with Toan Nguyen  
page 69

# INOX Door levers/Maniglie

Material: all stainless steel AISI 316 L



## H 5008 Serie Himalaya

design Taller Design Ricardo Bofill  
page 74



## H 5014 Serie Bernina

design Fusital Workshop  
page 75



## H 5015 Serie K2

design Antonio Citterio  
page 76-77



## H 5017 Serie Gottardo

design Hans Kollhoff  
page 78



## H 5021 Serie Arrowhead

design Frank O. Gehry  
page 79



# INOX Door knobs/Pomoli

Material: all stainless steel AISI 316 L



## K 5301

design Fusital Workshop  
page 81



## K 5302

design Fusital Workshop  
page 82

# INOX Door pulls/Maniglioni

Material: all stainless steel AISI 316 L



## P 5405 Serie Himalaya

design Taller Design Ricardo Bofill  
page 84



## P 5406 Serie K2

design Antonio Citterio  
page 85



## P 5408 Serie K2

design Antonio Citterio  
page 86

# Finishes

<b>U.S.A.</b>	<b>ITALY</b>
03 Polished Brass	03 Oro
03D Satin Brass	03D Orsatin
03M Matt Brass	03M Orsatin Opaco
06 Antique Brass	06 Patiné
06A Anticato	06A Anticato
06B Brunito	06B Brunito
06M Bronze Matt	06M Bronzo Opaco
14 Polished Nickel	14 Nikmatt Lucido
15 Satin Nickel	15 Nikmatt
15A Antique Nickel	15A Niksatin
16 Dull Black	16 Neropaco
17 Orolux (brass finish)	17 Orolux
17D Satin Orolux	17D Orolux Matt
18 Light Black	18 Light Black
21 Black Enamel	21 Nero
22 White Enamel	22 Bianco
22M Matt White	22M Bianco Opaco
24 Gold 24K	24 Oro Zecchino
26 Polished Chrome	26 Cromo
26D Satin Chrome	26D Cromsatin
32 Polished Stainless Steel	32 Lucido
32D Satin Stainless Steel	32D Satinato
Grey	Grigio (Tortora)
Grey/03 Grey Brass	Grigio (Tortora Oro)

**Additional special finishes available on request on all products. Price subject to minimum upcharge of 25%.**

#### HOW TO ORDER/Details page 15

To order Valli&Valli products, information should be specified in the same sequence as the example given:

<b>1.Lever/Knob</b>	<b>2.Trim options</b>	<b>3.Function</b>	<b>4.Finish</b>	<b>5.Handing</b>	<b>6.Backset</b>	<b>7.Miscellaneous</b>
HXXX	RP	ML XX	03	RH	2.1/2"	2.1/4" thick

For small rosette, please specify RS/RSQ (45 mm rosette). RS pricing is the same as RP/RT pricing. Privacy RS also requires 105 RSP when ordering. RQ (2.9/16" rosette) for standard 2.1/8" cross bore. RSQ pricing is the same as RQ. Privacy RSQ also requires 105 RSQ when ordering.

ET/EP = 03-26 Standard Finish, ER = 15-26-26D Standard Finish.

Conversion from metric to US measurement are approximate.

#### NON STANDARD PRODUCTION ITEM

**Minimum 10 sets Fusital item per order**

<b>Quantity</b>	<b>Add to retail price</b>
*between 10 - 25 set	\$ 390.00
*between 26 - 50 set	\$ 210.00
*between 51 - 75 set	\$ 150.00
*between 76 - 100 set	\$ 100.00

**Minimum 20 each Fusital item per order**

<b>Quantity</b>	<b>Add to retail price</b>
*between 20 - 50 each	\$ 200.00
*between 51 - 100 each	\$ 105.00
*between 101 - 150 each	\$ 75.00
*between 151 - 200 each	\$ 50.00

**FUSITAL** Door levers and knobs, pulls and decorative accessories

**FUSITAL INOX** Stainless steel levers, knobs and door pulls

# How to order: details

## 1. Lever or Knob

Choose from all Valli&Valli product lines

## 2. Trim Options

Choose from the following:

RT	standard traditional style rosette	RS	small rosette plain
RP	standard plain style rosette	RQS	standard square rosette stainless steel
RQ	standard square style rosette	ET	traditional style long escutcheon plate
RSM	small rosette multi point	EP	plain style long escutcheon plate
RST	small rosette traditional	ER	rectangular style long escutcheon plate
RSP	small rosette plain	ERS	rectangular style long escutcheon plate stainless steel
RSQ	small rosette square	NEP	narrow long escutcheon plate multi point
RSQS	small rosette square stainless steel	NES	narrow long escutcheon plate stainless steel multi point
RSSM	small stainless steel rosette-multi point	NER	narrow long rectangular escutcheon plate multi point
RSS	small stainless steel rosette	NERS	narrow long rectangular escutcheon plate multi point stainless steel
RPS	standard stainless steel rosette		

## 3. Function

Choose from the following:

PGE	passage	103	long escutcheon plate with passage set and single cylinder deadbolt
PCY	privacy	104	long escutcheon plate with passage set and double cylinder deadbolt
DMY	dummy	105	privacy bolt
101	dead bolt single cylinder	106	long escutcheon plate with passage set and privacy bolt
102	dead bolt double cylinder	ML F	mortise lock
		MULTI-POINT TRIM	

## 4. Finish

Choose from stock or custom order finishes. Upcharge will apply.

06, 06A, 06B	Face/Strike supplied with 06/antique brass finish
15, 32D	Face/Strike supplied with 15/satin nickel finish
14, 26, 32	Face/Strike supplied with 26/polished chrome finish
26D	Face/Strike supplied with 26D/satin chrome finish

## 5. Handing

Follow the diagram on page 123.

## 6. Backset

2.3/8" = tubular (standard)  
 2.3/4" = mortise (standard)  
 Specify for all non-standard backsets.

## 7. Miscellaneous

Note special door thickness, keying information, split finishes.  
 Note: Additional charges apply to these special details. See pricing list below.

**UL** Tubular Passage Latch available upon request.

### RUSH DELIVERY CHARGES \$ 25.00 NET

Applies to all orders requested to be shipped within 48 hrs.

### Drop ship charge = \$5.00 net

Applied to all drop ship orders

### KEYING CHARGES

Code #	Description (5 pin)	
KA	Keyed alike	No charge
KD	Keyed different	No charge
MK	Master keyed	Call factory for a quotation

Other keying options available upon request.

### CHARGES EXTRA THICK DOORS

\$ 50.00	2.1/4" thick door for tubular latch and deadbolt
\$ 70.00	2.1/2 " thick door for tubular latch and deadbolt
\$ 90.00	3" thick doors for tubular latch and deadbolt
\$ 70.00	2.1/4" thick door for mortise lock and multipoint
\$ 90.00	2.1/2" thick door for mortise lock
\$ 120.00	3" thick door for mortise lock

### DUMMY SET ADAPTOR/ See page 129

For 2.1/8" Pre-drilled doors  
 X003/1 Back to back application  
 X003/2 Single application  
 Add to Dummy retail price

### Split Finishes and Non-Standard Rosettes add to Retail Price

\$ 20.00	Split finishes add to the highest priced finish used.
\$ 100.00	non standard RQ square rosette list to the highest priced finish used, passage & privacy.
\$ 120.00	non standard RQS square stainless rosette list to the highest priced finish used, passage & privacy.
\$ 100.00	non standard ER Rectangular escutcheon list to the highest priced finish used.
\$ 100.00	non standard RSQ (45 mm rose) list to the highest priced finish used, passage. (For privacy, separate privacy bolt is required)
\$ 50.00	non standard RQ square rosette list to the highest priced finish used, per single Dummy.
\$ 60.00	non standard RQS square stainless rosette list to the highest priced finish used, per single Dummy.
\$ 50.00	non standard RSQ (45mm rosette) list to the highest priced finish used, per single Dummy.

Knobs cannot be mounted on escutcheon plates.

# Rosette options



**RP Rosette Plain Solid brass**  
**RPS Rosette Plain Stainless steel**  
65 mm (2.9/16")



**RQ Rosette Square Solid brass**  
**RQS Rosette Square Stainless steel**  
65 mm (2.9/16")



**RT Rosette Traditional Solid brass**  
65 mm (2.9/16")



**RS Small Rosette Solid brass**  
45 mm (1.3/4")



**RSS Small Rosette Stainless steel**  
50 mm (2")



**RSQ Small Rosette Square Solid brass**  
50 mm (2")

See page 56 for pricing

# Escutcheon plate options



60 mm (2.3/8")

**EP Plain Escutcheon  
Solid brass**

Plain escutcheon shown  
with thumbturn bolt  
60 mm (2.3/8")



57 mm (2.1/4")

**ET Traditional Escutcheon  
Solid brass**

Traditional escutcheon shown  
with thumbturn bolt  
57 mm (2.1/4")



65 mm (2.9/16")

**ER Rectangular Escutcheon Solid brass**

**ERS Rectangular Escutcheon  
Stainless steel**  
65 mm (2.9/16")



38 mm (1.1/2")

**NEP Narrow Plain  
Escutcheon Solid brass**

38 mm (1.1/2")



50 mm (2")

**NES Narrow Escutcheon  
Stainless steel**

50 mm (2")



38 mm (1.1/2")

**NER Narrow Rectangular  
Escutcheon Solid brass**

38 mm (1.1/2")



50 mm (2")

**NERS Narrow Rectangular  
Escutcheon Stainless steel**

50 mm (2")

Door levers +  
Window  
levers/  
Maniglie +  
Finestra

# H 37 Serie Tre B

design Cini Boeri



## Matching elements/Coordinato

- Pg 88** Mortise lock functions
- Pg 98** Deadbolts/Privacy Bolts
- Pg 104** Escutcheons with deadbolts
- Pg 109** Multi-Point Trim functions



## Sizes/Misure

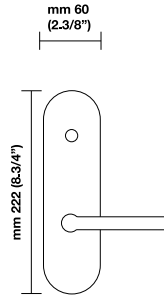
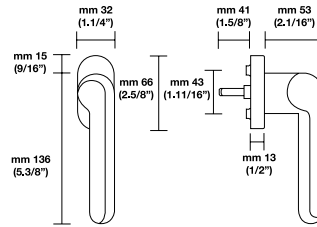
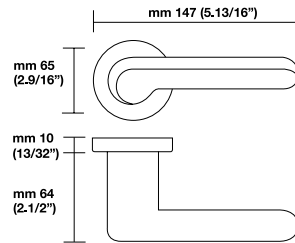

### Window handle/Maniglia per finestra H 37 F RS<sup>2</sup> Movement 4 click positions

### Escutcheon options/Opzioni EP





**Note** Conversions from metric to U.S. measurements are approximate.  
<sup>2</sup>Call for pricing.

## Retail Price

Finish			PGE	PCY /bolt	DMY R/L Single	ML-F ENTRY
03/03D	<b>RP</b>		\$ 467.00	\$ 677.00 <sup>3</sup>	\$ 229.00	\$ 960.00

<sup>3</sup>Supplied with 105 RSP Privacy Bolt

Finish			PGE	PCY /bolt	DMY R/L Single	DMY R/L Pair	ML-F ENTRY
03/03D	<b>EP</b>		\$ 641.00	\$ 733.00 <sup>3</sup>	\$ 311.00	\$ 578.00	\$ 920.00

<sup>3</sup>Supplied with 105 RSP Privacy Bolt



# H 310<sup>1</sup> Serie Cinque C

design Achille Castiglioni

## Matching elements/Coordinato

- Pg 88** Mortise lock functions
- Pg 98** Deadbolts/Privacy Bolts
- Pg 104** Escutcheons with deadbolts
- Pg 109** Multi-Point Trim functions



## Sizes/Misure

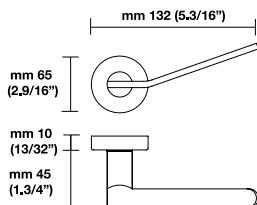

### Window handle/Maniglia per finestra H 310 F RS<sup>2</sup> Movement 4 click positions

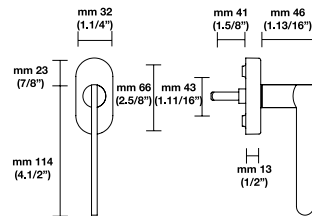



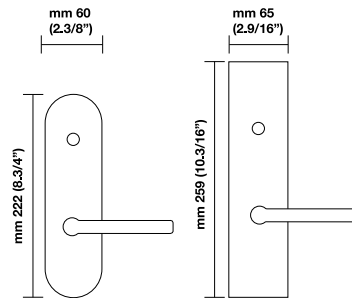

### Escutcheon options/Opzioni EP ER



**Note** Conversions from metric to U.S. measurements are approximate.  
<sup>2</sup>Call for pricing.

## Retail Price

Finish			PGE	PCY	DMY R/L Single	ML-F ENTRY
26	<b>RP</b>		\$ 319.00	\$ 340.00	\$ 149.00	\$ 870.00
26D	<b>RP</b>		\$ 319.00	\$ 340.00	\$ 149.00	\$ 870.00

Finish			PGE	PCY	DMY R/L Single	DMY R/L Pair	ML-F ENTRY
26	<b>EP</b>		\$ 540.00	\$ 550.00	\$ 260.00	\$ 480.00	\$ 820.00
		<b>ER</b>	\$ 580.00	\$ 590.00	\$ 290.00	\$ 530.00	\$ 850.00
26D	<b>EP</b>		\$ 540.00	\$ 550.00	\$ 260.00	\$ 480.00	\$ 820.00
		<b>ER</b>	\$ 580.00	\$ 590.00	\$ 290.00	\$ 530.00	\$ 850.00

<sup>1</sup>Not currently in production. Available for minimum quantity per order/Details page 14

# H 311 Serie Sei MB

design Mario Bellini

## Matching elements/Coordinato

- Pg 88** Mortise lock functions
- Pg 98** Deadbolts/Privacy Bolts
- Pg 104** Escutcheons with deadbolts
- Pg 109** Multi-Point Trim functions

## Rosette options/Opzioni RP

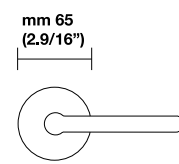

## Sizes/Misure

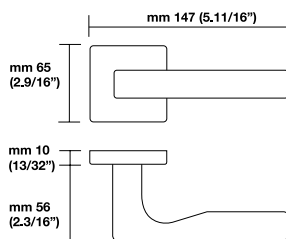

## Window handle/Maniglia per finestra H 311 F RS<sup>2</sup>

Movement 4 click positions

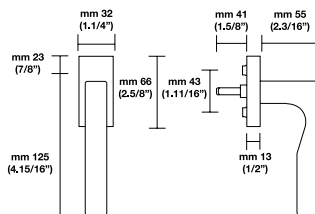



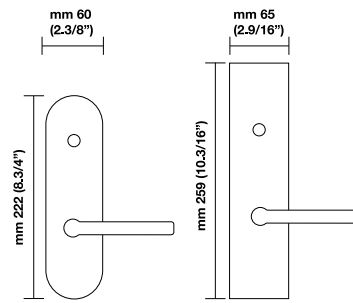







## Escutcheon options/Opzioni EP ER



**Note** Conversions from metric to U.S. measurements are approximate.  
<sup>2</sup>Call for pricing.

## Retail Price

Finish			PGE	PCY	DMY R/L Single	ML-F ENTRY
	<b>RP</b>		\$ 563.00	\$ 581.00	\$ 273.00	\$ 960.00
		<b>RQ</b>	\$ 679.00	\$ 696.00	\$ 338.00	\$ 1,100.00
	<b>RP</b>		\$ 571.00	\$ 587.00	\$ 276.00	\$ 960.00
		<b>RQ</b>	\$ 674.00	\$ 685.00	\$ 340.00	\$ 1,100.00
	<b>RP</b>		\$ 499.00	\$ 509.00	\$ 242.00	\$ 960.00
		<b>RQ</b>	\$ 595.00	\$ 610.00	\$ 297.00	\$ 1,100.00
	<b>RP</b>		\$ 525.00	\$ 539.00	\$ 254.00	\$ 960.00
		<b>RQ</b>	\$ 629.00	\$ 647.00	\$ 318.00	\$ 1,100.00

Finish			PGE	PCY	DMY R/L Single	DMY R/L Pair	ML-F ENTRY
	<b>EP</b>		\$ 650.00	\$ 660.00	\$ 320.00	\$ 600.00	\$ 920.00
		<b>ER</b>	\$ 719.00	\$ 724.00	\$ 359.00	\$ 664.00	\$ 950.00
	<b>EP</b>		\$ 650.00	\$ 660.00	\$ 320.00	\$ 600.00	\$ 920.00
		<b>ER</b>	\$ 696.00	\$ 701.00	\$ 342.00	\$ 636.00	\$ 950.00
	<b>EP</b>		\$ 650.00	\$ 660.00	\$ 320.00	\$ 600.00	\$ 920.00
		<b>ER</b>	\$ 719.00	\$ 724.00	\$ 359.00	\$ 664.00	\$ 950.00

# H 315 Serie G Novanta

design Pierluigi Cerri

## Matching elements/Coordinato

- Pg 88** Mortise lock functions
- Pg 98** Deadbolts/Privacy Bolts
- Pg 104** Escutcheons with deadbolts
- Pg 109** Multi-Point Trim functions



## Sizes/Misure

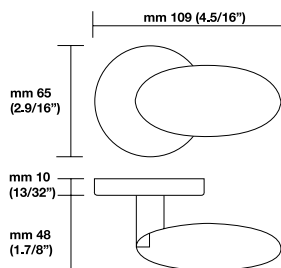

## Window handle/Maniglia per finestra H 315 F RS<sup>2</sup>

Movement 4 click positions

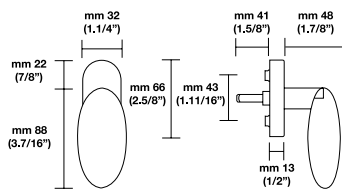

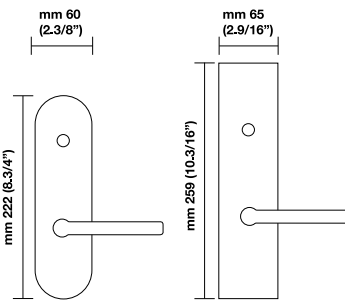

## Escutcheon options/Opzioni EP ER





**Note** Conversions from metric to U.S. measurements are approximate.  
<sup>2</sup>Call for pricing.

## Retail Price

Finish		PGE	PCY	DMY R/L Single	ML-F ENTRY	
	03/22	<b>RP</b>	\$ 382.00	\$ 409.00	\$ 185.00	\$ 870.00
	26/22	<b>RP</b>	\$ 377.00	\$ 403.00	\$ 185.00	\$ 870.00

Finish		PGE	PCY	DMY R/L Single	DMY R/L Pair	ML-F ENTRY	
	03/22	<b>EP</b>	\$ 540.00	\$ 563.00	\$ 268.00	\$ 497.00	\$ 820.00
	26/22	<b>EP</b>	\$ 540.00	\$ 563.00	\$ 268.00	\$ 497.00	\$ 820.00
		<b>ER</b>	\$ 580.00	\$ 590.00	\$ 290.00	\$ 530.00	\$ 850.00

**Note:** Porcelain - Not recommended for commercial use.

# H 317 Serie AC Novantuno

design Antonio Citterio

## Matching elements/Coordinato

- Pg 88** Mortise lock functions
- Pg 98** Deadbolts/Privacy Bolts
- Pg 104** Escutcheons with deadbolts
- Pg 109** Multi-Point Trim functions



## Sizes/Misure

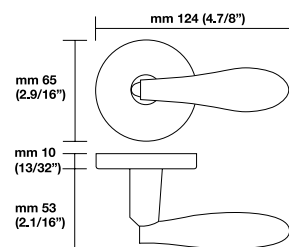

## Window handle/Maniglia per finestra H 317 F RS<sup>2</sup> Movement 4 click positions

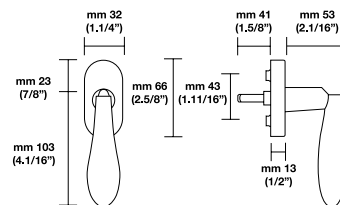



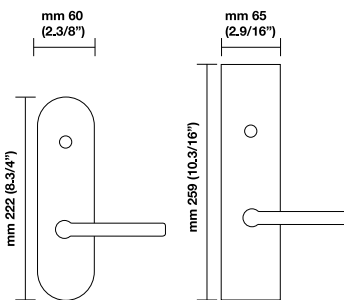

## Escutcheon options/Opzioni EP ER



**Note** Conversions from metric to U.S. measurements are approximate.  
<sup>2</sup>Call for pricing.

## Retail Price

Finish			PGE	PCY	DMY R/L Single	ML-F ENTRY
26	<b>RP</b>		\$ 382.00	\$ 393.00	\$ 180.00	\$ 870.00
26D	<b>RP</b>		\$ 392.00	\$ 409.00	\$ 185.00	\$ 870.00

Finish			PGE	PCY	DMY R/L Single	DMY R/L Pair	ML-F ENTRY
26	<b>EP</b>		\$ 543.00	\$ 563.00	\$ 266.00	\$ 494.00	\$ 820.00
		<b>ER</b>	\$ 580.00	\$ 590.00	\$ 290.00	\$ 530.00	\$ 850.00
26D	<b>EP</b>		\$ 539.00	\$ 568.00	\$ 266.00	\$ 487.00	\$ 820.00
		<b>ER</b>	\$ 580.00	\$ 590.00	\$ 290.00	\$ 530.00	\$ 850.00

# H 326 Serie AC 1 Novantacinque

design Antonio Citterio

## Matching elements/Coordinato

- Pg 88** Mortise lock functions
- Pg 98** Deadbolts/Privacy Bolts
- Pg 104** Escutcheons with deadbolts
- Pg 109** Multi-Point Trim functions



## Sizes/Misure

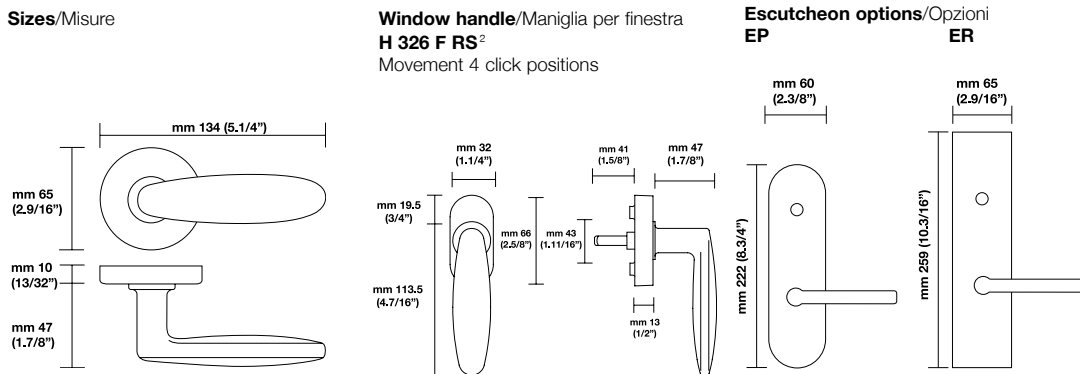

**Note** Conversions from metric to U.S. measurements are approximate.  
<sup>2</sup>Call for pricing.

## Retail Price

Finish		PGE	PCY	DMY R/L Single	DMY R/L Pair	ML-F ENTRY
03	RP	\$ 292.00	\$ 315.00	\$ 140.00		\$ 870.00
26D	RP	\$ 299.00	\$ 317.00	\$ 141.00		\$ 870.00
Finish		PGE	PCY	DMY R/L Single	DMY R/L Pair	ML-F ENTRY
03	EP	\$ 457.00	\$ 478.00	\$ 223.00	\$ 403.00	\$ 820.00
26D	EP	\$ 457.00	\$ 478.00	\$ 223.00	\$ 403.00	\$ 820.00
	ER	\$ 580.00	\$ 590.00	\$ 290.00	\$ 530.00	\$ 850.00

# H 327 Serie AC 2 Novantacinque

design Antonio Citterio



## Matching elements/Coordinato

- Pg 88** Mortise lock functions
- Pg 98** Deadbolts/Privacy Bolts
- Pg 104** Escutcheons with deadbolts
- Pg 109** Multi-Point Trim functions





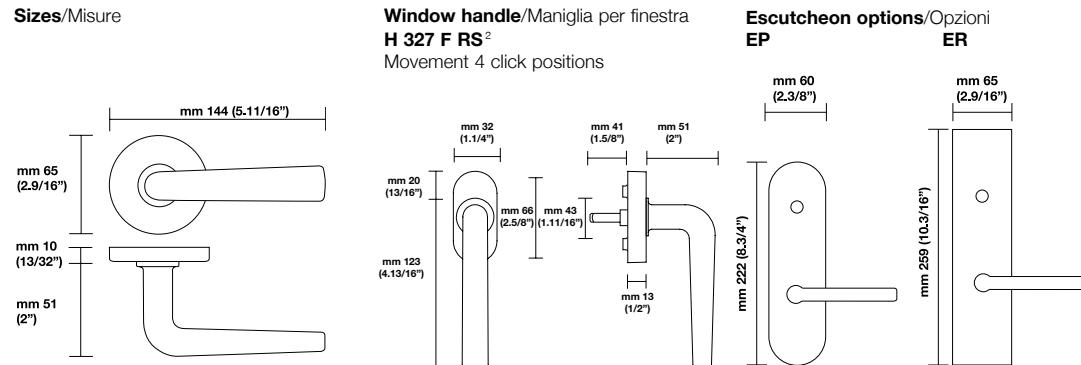





## Sizes/Misure



**Note** Conversions from metric to U.S. measurements are approximate.  
<sup>2</sup>Call for pricing.

## Retail Price

Finish			PGE	PCY	DMY R/L Single	ML-F ENTRY
	03	<b>RP</b>	\$ 295.00	\$ 314.00	\$ 139.00	\$ 870.00
	26D	<b>RP</b>	\$ 300.00	\$ 317.00	\$ 142.00	\$ 870.00

Finish			PGE	PCY	DMY R/L Single	DMY R/L Pair	ML-F ENTRY
	03	<b>EP</b>	\$ 457.00	\$ 478.00	\$ 223.00	\$ 403.00	\$ 820.00
	26D	<b>EP</b>	\$ 457.00	\$ 478.00	\$ 223.00	\$ 403.00	\$ 820.00
		<b>ER</b>	\$ 580.00	\$ 590.00	\$ 290.00	\$ 530.00	\$ 850.00

# H 329 Serie RB Novantacinque

design Taller Design Ricardo Bofill

## Matching elements/Coordinato

- Pg 88** Mortise lock functions
- Pg 98** Deadbolts/Privacy Bolts
- Pg 104** Escutcheons with deadbolts
- Pg 109** Multi-Point Trim functions

## Rosette options/Opzioni RP

mm 65  
(2.9/16")

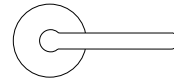

## Sizes/Misure

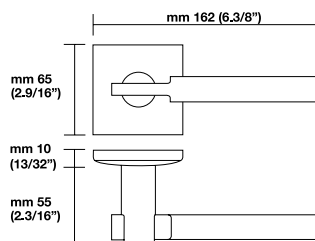

## Window handle/Maniglia per finestra H 329 F RS<sup>2</sup> Movement 4 click positions

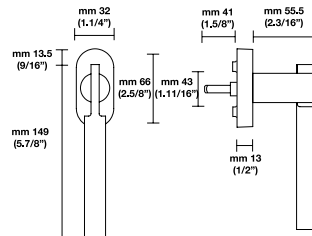



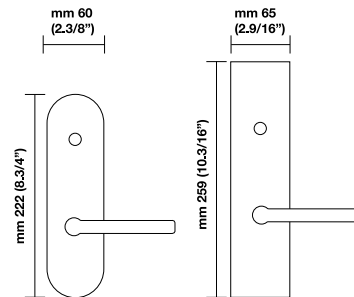

## Escutcheon options/Opzioni EP ER



**Note** Conversions from metric to U.S. measurements are approximate.  
<sup>2</sup>Call for pricing.

## Retail Price

Finish			PGE	PCY	DMY R/L Single	ML-F ENTRY
03/03D	<b>RP</b>		\$ 461.00	\$ 484.00	\$ 221.00	\$ 960.00
26/26D	<b>RP</b>		\$ 461.00	\$ 484.00	\$ 221.00	\$ 960.00
		<b>RQ</b>	\$ 558.00	\$ 572.00	\$ 279.00	\$ 1,100.00

Finish			PGE	PCY	DMY R/L Single	DMY R/L Pair	ML-F ENTRY
03/03D	<b>EP</b>		\$ 641.00	\$ 659.00	\$ 314.00	\$ 585.00	\$ 920.00
26/26D	<b>EP</b>		\$ 641.00	\$ 659.00	\$ 314.00	\$ 585.00	\$ 920.00
		<b>ER</b>	\$ 674.00	\$ 684.00	\$ 329.00	\$ 615.00	\$ 950.00



# H 330 Serie T Novantasette

design Matteo Thun

## Matching elements/Coordinato

- Pg 88** Mortise lock functions
- Pg 98** Deadbolts/Privacy Bolts
- Pg 104** Escutcheons with deadbolts
- Pg 109** Multi-Point Trim functions



## Sizes/Misure

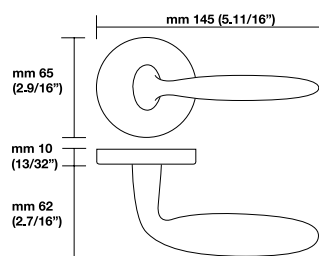

## Window handle/Maniglia per finestra H 330 F RS<sup>2</sup>

Movement 4 click positions

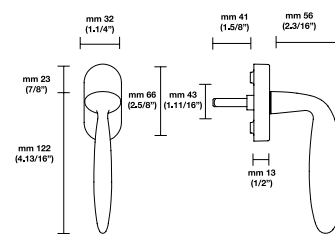

## Escutcheon options/Opzioni EP ER

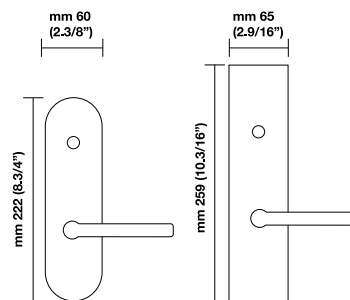

**Note** Conversions from metric to U.S. measurements are approximate.

<sup>2</sup>Call for pricing.

## Retail Price

Finish			PGE	PCY	DMY R/L Single	ML-F ENTRY
	03 <sup>1</sup>	<b>RP</b>	\$ 334.00	\$ 354.00	\$ 158.00	\$ 870.00
	03D <sup>1</sup>	<b>RP</b>	\$ 324.00	\$ 342.00	\$ 154.00	\$ 870.00
	14 <sup>1</sup>	<b>RP</b>	\$ 388.00	\$ 403.00	\$ 186.00	\$ 870.00
	15 <sup>1</sup>	<b>RP</b>	\$ 351.00	\$ 366.00	\$ 164.00	\$ 870.00
	26	<b>RP</b>	\$ 348.00	\$ 372.00	\$ 166.00	\$ 870.00
	26D	<b>RP</b>	\$ 340.00	\$ 356.00	\$ 160.00	\$ 870.00

Finish			PGE	PCY	DMY R/L Single	DMY R/L Pair	ML-F ENTRY
	03 <sup>1</sup>	<b>EP</b>	\$ 494.00	\$ 509.00	\$ 245.00	\$ 446.00	\$ 820.00
	03D <sup>1</sup>	<b>EP</b>	\$ 489.00	\$ 499.00	\$ 239.00	\$ 435.00	\$ 820.00
	15 <sup>1</sup>	<b>EP</b>	\$ 540.00	\$ 550.00	\$ 260.00	\$ 480.00	\$ 820.00
		<b>ER</b>	\$ 580.00	\$ 590.00	\$ 290.00	\$ 530.00	\$ 850.00
	26	<b>EP</b>	\$ 540.00	\$ 550.00	\$ 252.00	\$ 480.00	\$ 820.00
		<b>ER</b>	\$ 580.00	\$ 590.00	\$ 290.00	\$ 530.00	\$ 850.00
	26D	<b>EP</b>	\$ 491.00	\$ 521.00	\$ 239.00	\$ 430.00	\$ 820.00
		<b>ER</b>	\$ 580.00	\$ 590.00	\$ 290.00	\$ 530.00	\$ 850.00

<sup>1</sup>Not currently in production. Available for minimum quantity per order/Details page 14

# H 332' Serie M Novantotto

design Renzo Mongiardino

## Matching elements/Coordinato

- Pg 88** Mortise lock functions
- Pg 98** Deadbolts/Privacy Bolts
- Pg 104** Escutcheons with deadbolts
- Pg 109** Multi-Point Trim functions



European version rosette

## Sizes/Misure

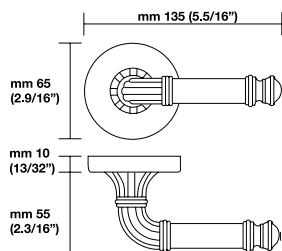

## Window handle/Maniglia per finestra H 332 F RS<sup>2</sup> Movement 4 click positions

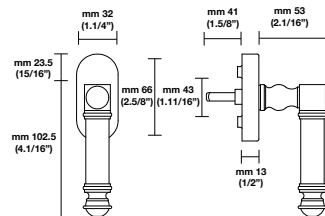

## Escutcheon options/Opzioni EP

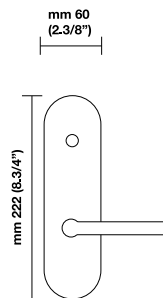

**Note** Conversions from metric to U.S. measurements are approximate.  
<sup>2</sup>Call for pricing.

## Retail Price

Finish		PGE	PCY /bolt	DMY R/L Single	ML-F ENTRY
03	<b>RP</b>	\$ 637.00	\$ 849.00 <sup>3</sup>	\$ 315.00	\$ 960.00
06B	<b>RP</b>	\$ 701.00	\$ 913.00 <sup>3</sup>	\$ 342.00	\$ 960.00

<sup>3</sup>Supplied with 105 RSP Privacy Bolt

Finish		PGE	PCY /bolt	DMY R/L Single	DMY R/L Pair	ML-F ENTRY
03	<b>EP</b>	\$ 807.00	\$ 1,040.00 <sup>3</sup>	\$ 398.00	\$ 753.00	\$ 920.00

<sup>3</sup>Supplied with 105 RSP Privacy Bolt

<sup>1</sup>Not currently in production. Available for minimum quantity per order/Details page 14

# H 334 Serie NF Novantotto

design Foster and Partners



## Matching elements/Coordinato

- Pg 88** Mortise lock functions
- Pg 98** Deadbolts/Privacy Bolts
- Pg 104** Escutcheons with deadbolts
- Pg 109** Multi-Point Trim functions



## Sizes/Misure

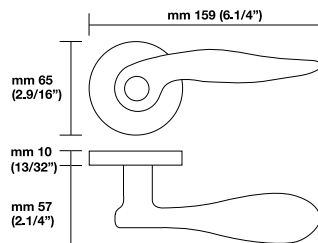

## Window Handle/Maniglia per finestra H 334 F RS<sup>c</sup>

Movement 4 click positions

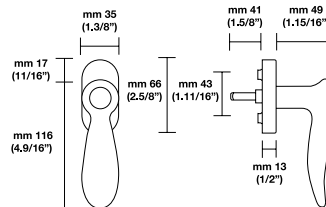



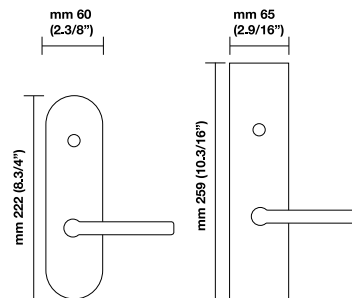





## Escutcheon options/Opzioni EP ER



**Note** Conversions from metric to U.S. measurements are approximate.  
<sup>c</sup>Call for pricing.

## Retail Price

Finish			PGE	PCY	DMY R/L Single	ML-F ENTRY
	03	<b>RP</b>	\$ 420.00	\$ 434.00	\$ 199.00	\$ 870.00
	26D	<b>RP</b>	\$ 424.00	\$ 437.00	\$ 201.00	\$ 870.00

Finish			PGE	PCY	DMY R/L Single	DMY R/L Pair	ML-F ENTRY
	03	<b>EP</b>	\$ 595.00	\$ 605.00	\$ 287.00	\$ 531.00	\$ 820.00
	26D	<b>EP</b>	\$ 595.00	\$ 605.00	\$ 287.00	\$ 531.00	\$ 820.00
		<b>ER</b>	\$ 580.00	\$ 590.00	\$ 290.00	\$ 530.00	\$ 850.00

# H 335' Serie RM Novantotto

design Richard Meier

## Matching elements/Coordinato

- Pg 88** Mortise lock functions
- Pg 98** Deadbolts/Privacy Bolts
- Pg 104** Escutcheons with deadbolts
- Pg 109** Multi-Point Trim functions





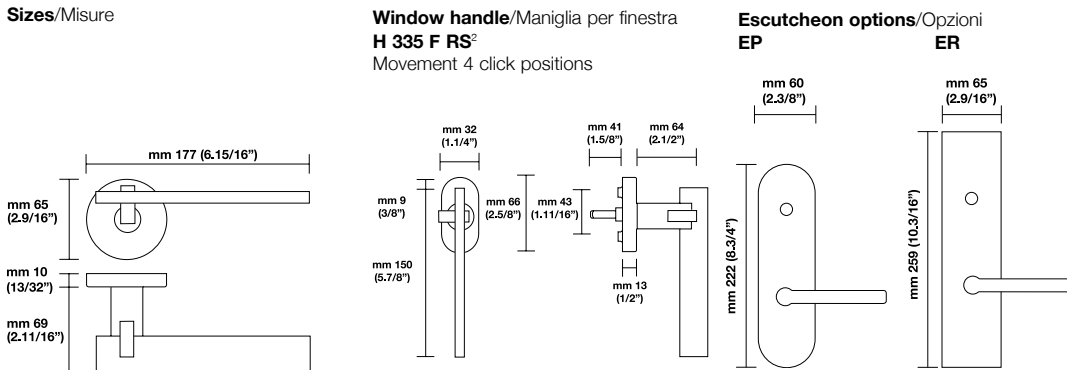

## Sizes/Misure



**Note** Conversions from metric to U.S. measurements are approximate.  
<sup>2</sup>Call for pricing.

## Retail Price

Finish			PGE	PCY	DMY R/L Single	ML-F ENTRY	
26	RP		\$ 563.00	\$ 596.00	\$ 276.00	\$ 960.00	
Finish			PGE	PCY	DMY R/L Single	DMY R/L Pair	ML-F ENTRY
26	EP		\$ 710.00	\$ 742.00	\$ 361.00	\$ 679.00	\$ 920.00
		ER	\$ 680.00	\$ 690.00	\$ 340.00	\$ 640.00	\$ 950.00

<sup>1</sup>Not currently in production. Available for minimum quantity per order/Details page 14

# H 338<sup>1</sup> Serie YK Duemila

design Yoshimi Kono

## Matching elements/Coordinato

- Pg 88** Mortise lock functions
- Pg 98** Deadbolts/Privacy Bolts
- Pg 104** Escutcheons with deadbolts
- Pg 109** Multi-Point Trim functions



## Sizes/Misure

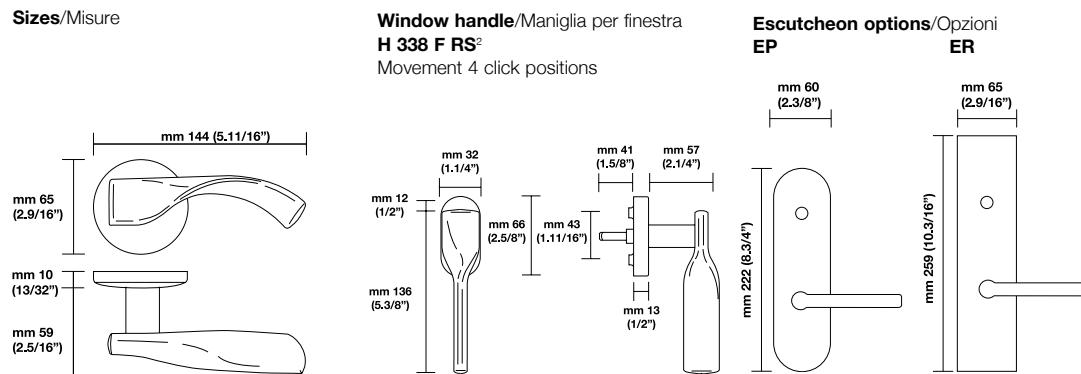







**Window handle/Maniglia per finestra**  
**H 338 F RS<sup>2</sup>**  
 Movement 4 click positions







**Escutcheon options/Opzioni**  
**EP ER**

**Note** Conversions from metric to U.S. measurements are approximate.  
<sup>2</sup>Call for pricing.

## Retail Price

Finish			PGE	PCY	DMY R/L Single	ML-F ENTRY
	03	<b>RP</b>	\$ 346.00	\$ 363.00	\$ 164.00	\$ 870.00
	03D	<b>RP</b>	\$ 349.00	\$ 369.00	\$ 166.00	\$ 870.00
	14	<b>RP</b>	\$ 387.00	\$ 398.00	\$ 183.00	\$ 870.00
	15	<b>RP</b>	\$ 379.00	\$ 388.00	\$ 177.00	\$ 870.00
	26D	<b>RP</b>	\$ 351.00	\$ 363.00	\$ 164.00	\$ 870.00

Finish			PGE	PCY	DMY R/L Single	DMY R/L Pair	ML-F ENTRY
	03	<b>EP</b>	\$ 521.00	\$ 531.00	\$ 340.00	\$ 457.00	\$ 820.00
	03D	<b>EP</b>	\$ 521.00	\$ 531.00	\$ 340.00	\$ 457.00	\$ 820.00
	15	<b>EP</b>	\$ 509.00	\$ 526.00	\$ 250.00	\$ 446.00	\$ 820.00
		<b>ER</b>	\$ 580.00	\$ 590.00	\$ 290.00	\$ 530.00	\$ 850.00
	26D	<b>EP</b>	\$ 509.00	\$ 526.00	\$ 250.00	\$ 446.00	\$ 820.00
		<b>ER</b>	\$ 580.00	\$ 590.00	\$ 290.00	\$ 530.00	\$ 850.00

<sup>1</sup>Not currently in production. Available for minimum quantity per order/Details page 14

# H 341 Serie HK2 Duemila

design Hans Kollhoff

## Matching elements/Coordinato

- Pg 88** Mortise lock functions
- Pg 98** Deadbolts/Privacy Bolts
- Pg 104** Escutcheons with deadbolts
- Pg 109** Multi-Point Trim functions

## Rosette options/Opzioni RP

mm 65  
(2.9/16")

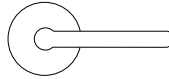

## Sizes/Misure

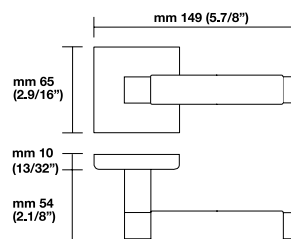

## Window handle/Maniglia per finestra H 341 F RS<sup>2</sup> Movement 4 click positions

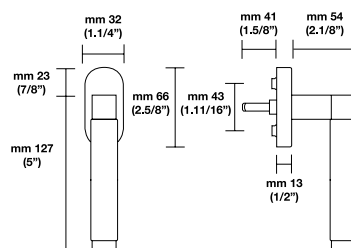



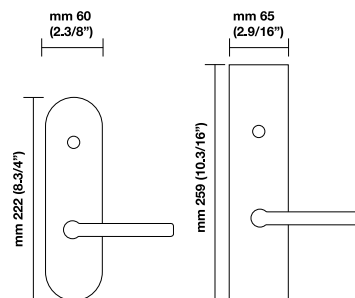

## Escutcheon options/Opzioni EP ER



**Note** Conversions from metric to U.S. measurements are approximate.  
<sup>2</sup>Call for pricing.

## Retail Price

Finish	 	PGE	PCY	DMY R/L Single	DMY R/L Pair	ML-F ENTRY
26/32D	<b>RP</b>	\$ 369.00	\$ 381.00	\$ 175.00		\$ 870.00
	<b>RQ</b>	\$ 467.00	\$ 480.00	\$ 232.00		\$ 980.00
Finish	 	PGE	PCY	DMY R/L Single	DMY R/L Pair	ML-F ENTRY
26/32D	<b>EP</b>	\$ 531.00	\$ 546.00	\$ 260.00	\$ 478.00	\$ 820.00
	<b>ER</b>	\$ 563.00	\$ 573.00	\$ 277.00	\$ 509.00	\$ 850.00

Solid brass and 316L stainless steel material

# H 343 Serie JP Duemila

design John Pawson

## Matching elements/Coordinato

- Pg 88** Mortise lock functions
- Pg 98** Deadbolts/Privacy Bolts
- Pg 104** Escutcheons with deadbolts
- Pg 109** Multi-Point Trim functions

## Rosette options/Opzioni RP

mm 65  
(2.9/16")

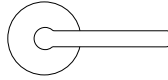

## Sizes/Misure

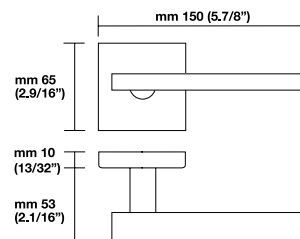

## Window handle/Maniglia per finestra

### H 343 F RS<sup>2</sup>

Movement 4 click positions

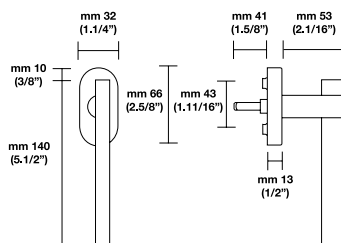

## Escutcheon options/Opzioni

### EP

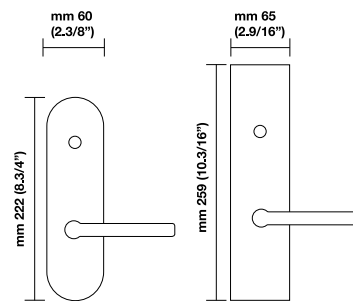

### ER





**Note** Conversions from metric to U.S. measurements are approximate.

<sup>2</sup>Call for pricing.

## Retail Price

Finish	 	PGE	PCY	DMY R/L Single	ML-F ENTRY
	<b>RP</b>	\$ 494.00	\$ 521.00	\$ 243.00	\$ 960.00
	<b>RQ</b>	\$ 597.00	\$ 623.00	\$ 319.00	\$ 1,100.00
14	<b>RP</b>	\$ 509.00	\$ 541.00	\$ 253.00	\$ 960.00
	<b>RQ</b>	\$ 627.00	\$ 657.00	\$ 318.00	\$ 1,100.00
15	<b>RP</b>	\$ 494.00	\$ 521.00	\$ 243.00	\$ 960.00
	<b>RQ</b>	\$ 599.00	\$ 621.00	\$ 306.00	\$ 1,100.00
26	<b>RP</b>	\$ 452.00	\$ 475.00	\$ 221.00	\$ 960.00
	<b>RQ</b>	\$ 551.00	\$ 578.00	\$ 277.00	\$ 1,100.00
26D	<b>RP</b>	\$ 471.00	\$ 497.00	\$ 232.00	\$ 960.00
	<b>RQ</b>	\$ 582.00	\$ 609.00	\$ 295.00	\$ 1,100.00

Finish	 	PGE	PCY	DMY R/L Single	DMY R/L Pair	ML-F ENTRY
15	<b>EP</b>	\$ 641.00	\$ 669.00	\$ 314.00	\$ 578.00	\$ 920.00
	<b>ER</b>	\$ 691.00	\$ 696.00	\$ 340.00	\$ 632.00	\$ 950.00
26	<b>EP</b>	\$ 641.00	\$ 669.00	\$ 314.00	\$ 578.00	\$ 920.00
	<b>ER</b>	\$ 664.00	\$ 669.00	\$ 327.00	\$ 610.00	\$ 950.00
26D	<b>EP</b>	\$ 641.00	\$ 669.00	\$ 314.00	\$ 578.00	\$ 920.00
	<b>ER</b>	\$ 691.00	\$ 696.00	\$ 340.00	\$ 632.00	\$ 950.00



# H 344<sup>1</sup> Serie JN Duemilauno

design Jean Nouvel

## Matching elements/Coordinato

**Pg 88** Mortise lock functions  
**Pg 98** Deadbolts/Privacy Bolts



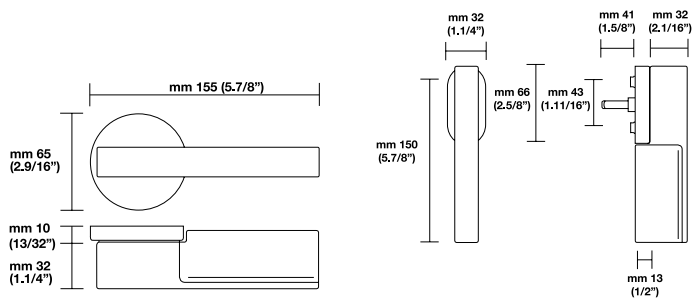

## Sizes/Misure

### Window handle/Maniglia per finestra **H 344 F RS<sup>2</sup>** Movement 4 click positions



**Note** Conversions from metric to U.S. measurements are approximate.  
<sup>2</sup>Call for pricing.

## Retail Price

Finish			PGE	PCY /bolt	DMY R/L Single	ML-F ENTRY
26	<b>RP</b>		\$ 934.00	\$ 1,146.00 <sup>3</sup>	\$ 457.00	\$ 1,320.00
26D	<b>RP</b>		\$ 943.00	\$ 1,184.00 <sup>3</sup>	\$ 458.00	\$ 1,320.00

<sup>3</sup>Supplied with 105 RSP Privacy Bolt

**NOTE:** Not available with long escutcheon. Available only on RP roses.

<sup>1</sup>Not currently in production. Available for minimum quantity per order/Details page 14

# H 348 Serie DC Duemiladue

design David Chipperfield Architects



## Matching elements/Coordinato

- Pg 88** Mortise lock functions
- Pg 98** Deadbolts/Privacy Bolts
- Pg 104** Escutcheons with deadbolts
- Pg 109** Multi-Point Trim functions



## Sizes/Misure

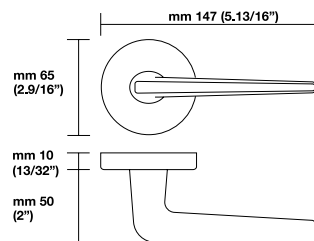

## Window handle/Maniglia per finestra H 348 F RS<sup>2</sup> Movement 4 click positions

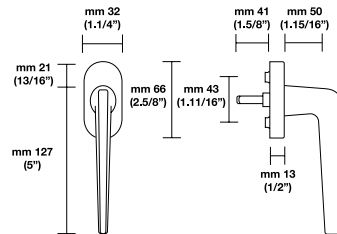

## Escutcheon options/Opzioni EP ER

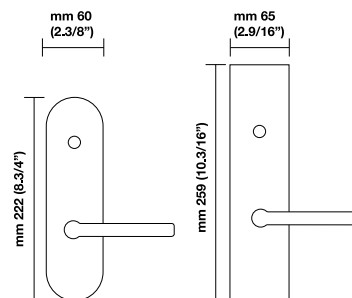

**Note** Conversions from metric to U.S. measurements are approximate.  
<sup>2</sup>Call for pricing.

## Retail Price

Finish		PGE	PCY	DMY R/L Single	ML-F ENTRY
03/03D <sup>1</sup>	<b>RP</b>	\$ 349.00	\$ 369.00	\$ 166.00	\$ 870.00
14	<b>RP</b>	\$ 391.00	\$ 403.00	\$ 186.00	\$ 870.00
15	<b>RP</b>	\$ 433.00	\$ 446.00	\$ 208.00	\$ 870.00
26	<b>RP</b>	\$ 349.00	\$ 369.00	\$ 166.00	\$ 870.00
26D	<b>RP</b>	\$ 353.00	\$ 372.00	\$ 168.00	\$ 870.00

Finish			PGE	PCY	DMY R/L Single	DMY R/L Pair	ML-F ENTRY
03/03D <sup>1</sup>	<b>EP</b>		\$ 520.00	\$ 530.00	\$ 255.00	\$ 465.00	\$ 820.00
15	<b>EP</b>		\$ 540.00	\$ 550.00	\$ 260.00	\$ 480.00	\$ 820.00
	<b>ER</b>		\$ 580.00	\$ 590.00	\$ 290.00	\$ 530.00	\$ 850.00
26	<b>EP</b>		\$ 523.00	\$ 536.00	\$ 255.00	\$ 465.00	\$ 820.00
	<b>ER</b>		\$ 580.00	\$ 590.00	\$ 290.00	\$ 530.00	\$ 850.00
26D	<b>EP</b>		\$ 523.00	\$ 536.00	\$ 255.00	\$ 465.00	\$ 820.00
	<b>ER</b>		\$ 580.00	\$ 590.00	\$ 290.00	\$ 530.00	\$ 850.00

<sup>1</sup>Not currently in production. Available for minimum quantity per order/Details page 14

# H 350 Serie CA Duemiladue

design Cerri&Associati

## Matching elements/Coordinato

- Pg 88** Mortise lock functions
- Pg 98** Deadbolts/Privacy Bolts
- Pg 104** Escutcheons with deadbolts
- Pg 109** Multi-Point Trim functions

## Rosette options/Opzioni RP

mm 65  
(2.9/16")

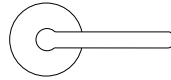

## Sizes/Misure

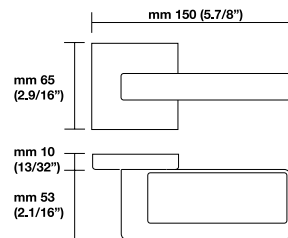

## Window handle/Maniglia per finestra

**H 350 F RS<sup>2</sup>**

Movement 4 click positions

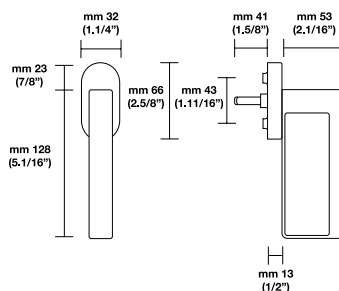

## Escutcheon options/Opzioni

**EP**

**ER**

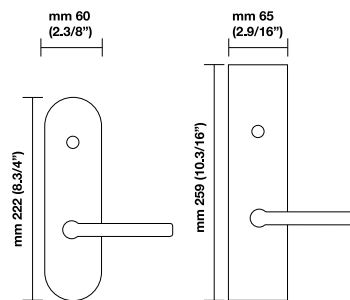

**Note** Conversions from metric to U.S. measurements are approximate.

<sup>2</sup>Call for pricing.

## Retail Price

Finish			PGE	PCY	DMY R/L Single	ML-F ENTRY
14	RP		\$ 918.00	\$ 929.00	\$ 446.00	\$ 1,280.00
	RQ		\$ 1,027.00	\$ 1,042.00	\$ 515.00	\$ 1,390.00
15	RP		\$ 918.00	\$ 929.00	\$ 446.00	\$ 1,280.00
	RQ		\$ 1,021.00	\$ 1,035.00	\$ 511.00	\$ 1,390.00
26	RP		\$ 805.00	\$ 817.00	\$ 391.00	\$ 1,280.00
	RQ		\$ 903.00	\$ 916.00	\$ 450.00	\$ 1,390.00
26D	RP		\$ 812.00	\$ 822.00	\$ 395.00	\$ 1,280.00
	RQ		\$ 918.00	\$ 932.00	\$ 462.00	\$ 1,390.00

Finish			PGE	PCY	DMY R/L Single	DMY R/L Pair	ML-F ENTRY
15	EP		\$ 940.00	\$ 980.00	\$ 460.00	\$ 880.00	\$ 1,230.00
	ER		\$ 1,014.00	\$ 1,019.00	\$ 499.00	\$ 954.00	\$ 1,260.00
26	EP		\$ 940.00	\$ 980.00	\$ 460.00	\$ 880.00	\$ 1,230.00
	ER		\$ 1,014.00	\$ 1,019.00	\$ 499.00	\$ 954.00	\$ 1,260.00
26D	EP		\$ 940.00	\$ 980.00	\$ 460.00	\$ 880.00	\$ 1,230.00
	ER		\$ 1,014.00	\$ 1,019.00	\$ 499.00	\$ 954.00	\$ 1,260.00

# H 352<sup>1</sup> Serie ODBC Duemiladue

design Odile Decq-Benoit Cornette



## Matching elements/Coordinato

- Pg 88** Mortise lock functions
- Pg 98** Deadbolts/Privacy Bolts
- Pg 104** Escutcheons with deadbolts
- Pg 109** Multi-Point Trim functions



## Sizes/Misure

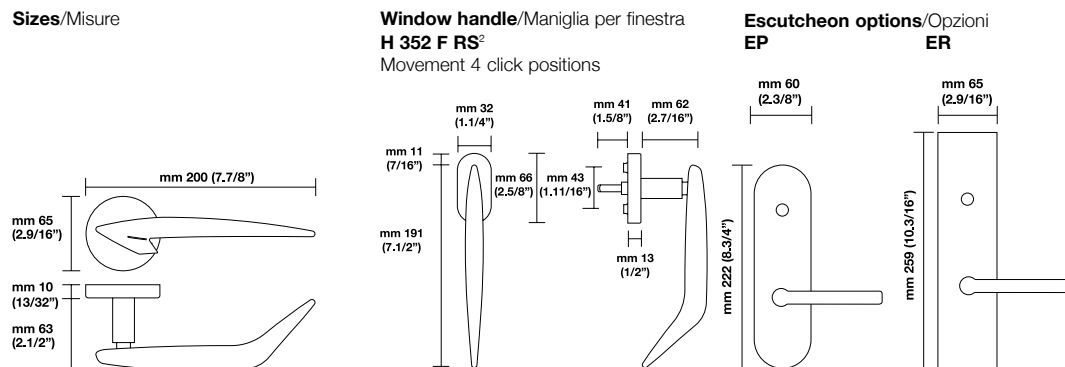

**Note** Conversions from metric to U.S. measurements are approximate.  
<sup>2</sup>Call for pricing.

## Retail Price

Finish		PGE	PCY	DMY R/L Single	ML-F ENTRY		
●	26	<b>RP</b>	\$ 688.00	\$ 701.00	\$ 339.00	\$ 1,320.00	
	26D	<b>RP</b>	\$ 724.00	\$ 738.00	\$ 353.00	\$ 1,320.00	
Finish		PGE	PCY	DMY R/L Single	DMY R/L Pair	ML-F ENTRY	
●	26	<b>EP</b>	\$ 1,000.00	\$ 1,020.00	\$ 500.00	\$ 950.00	\$ 1,280.00
		<b>ER</b>	\$ 1,050.00	\$ 1,060.00	\$ 520.00	\$ 990.00	\$ 1,310.00
●	26D	<b>EP</b>	\$ 1,000.00	\$ 1,020.00	\$ 500.00	\$ 950.00	\$ 1,280.00
		<b>ER</b>	\$ 1,050.00	\$ 1,060.00	\$ 520.00	\$ 990.00	\$ 1,310.00

<sup>1</sup>Not currently in production. Available for minimum quantity per order/Details page 14

# H 354 Serie Fog Duemilaquattro

design Frank O. Gehry

## Matching elements/Coordinato

- Pg 88** Mortise lock functions
- Pg 98** Deadbolts/Privacy Bolts
- Pg 104** Escutcheons with deadbolts
- Pg 109** Multi-Point Trim functions





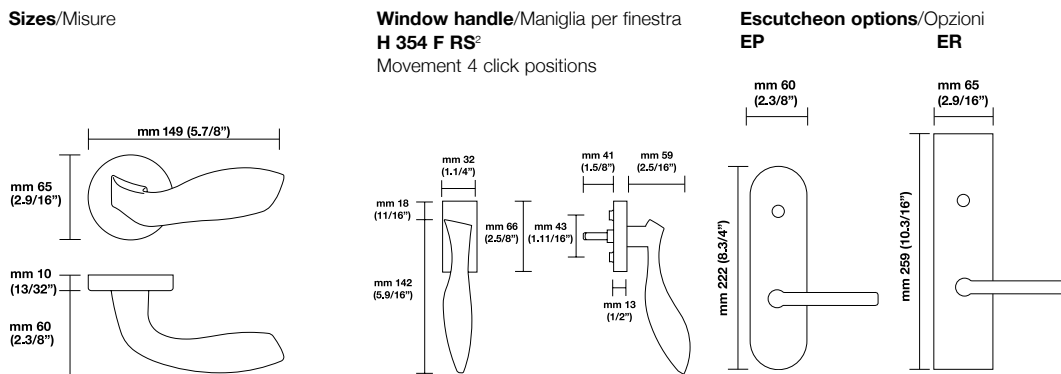





## Sizes/Misure



**Note** Conversions from metric to U.S. measurements are approximate.  
<sup>2</sup>Call for pricing.

## Retail Price

Finish			PGE	PCY	DMY R/L Single	DMY R/L Pair	ML-F ENTRY
	26	<b>RP</b>	\$ 843.00	\$ 865.00	\$ 418.00		\$ 1,320.00
	26D	<b>RP</b>	\$ 882.00	\$ 908.00	\$ 438.00		\$ 1,320.00
Finish			PGE	PCY	DMY R/L Single	DMY R/L Pair	ML-F ENTRY
	26	<b>EP</b>	\$ 1,000.00	\$ 1,020.00	\$ 500.00	\$ 950.00	\$ 1,280.00
		<b>ER</b>	\$ 1,050.00	\$ 1,060.00	\$ 520.00	\$ 990.00	\$ 1,310.00
	26D	<b>EP</b>	\$ 1,000.00	\$ 1,020.00	\$ 500.00	\$ 950.00	\$ 1,280.00
		<b>ER</b>	\$ 1,050.00	\$ 1,060.00	\$ 520.00	\$ 990.00	\$ 1,310.00

# H 355<sup>1</sup> Serie Ramsa Duemilaquattro

design Robert AM Stern Architect



## Matching elements/Coordinato

- Pg 88** Mortise lock functions
- Pg 98** Deadbolts/Privacy Bolts
- Pg 104** Escutcheons with deadbolts
- Pg 109** Multi-Point Trim functions



## Sizes/Misure

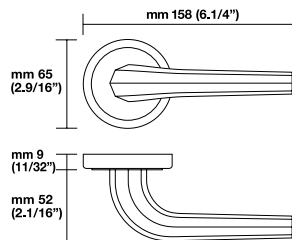

## Window handle/Maniglia per finestra H 355 F RS<sup>2</sup>

Movement 4 click positions

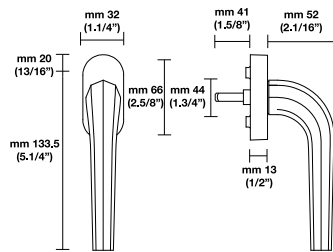

## Escutcheon options/Opzioni



**ET**

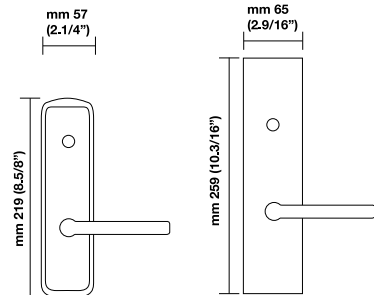

**ER**



**Note** Conversions from metric to U.S. measurements are approximate.  
<sup>2</sup>Call for pricing.

## Retail Price

Finish			PGE	PCY	DMY R/L Single	ML-F ENTRY
26	<b>RT</b>		\$ 412.00	\$ 435.00	\$ 198.00	\$ 870.00
26D	<b>RT</b>		\$ 459.00	\$ 484.00	\$ 220.00	\$ 870.00

Finish			PGE	PCY	DMY R/L Single	DMY R/L Pair	ML ENTRY
26	<b>ET</b>		\$ 540.00	\$ 550.00	\$ 260.00	\$ 480.00	\$ 820.00
		<b>ER</b>	\$ 580.00	\$ 590.00	\$ 290.00	\$ 530.00	\$ 850.00
26D	<b>ET</b>		\$ 540.00	\$ 550.00	\$ 260.00	\$ 480.00	\$ 820.00
		<b>ER</b>	\$ 580.00	\$ 590.00	\$ 290.00	\$ 530.00	\$ 850.00

<sup>1</sup>Not currently in production. Available for minimum quantity per order/Details page 14

# H 356 Serie ZH Duemilacinque

design Zaha Hadid with Woody Yao

## Matching elements/Coordinato

- Pg 88** Mortise lock functions
- Pg 98** Deadbolts/Privacy Bolts
- Pg 104** Escutcheons with deadbolts
- Pg 109** Multi-Point Trim functions

## Rosette options/Opzioni RP

mm 65  
(2.9/16")

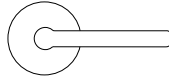

European version rosette

## Sizes/Misure

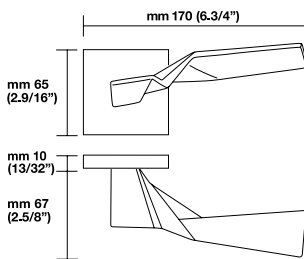

## Window handle/Maniglia per finestra H 356 F RS<sup>2</sup> Movement 4 click positions

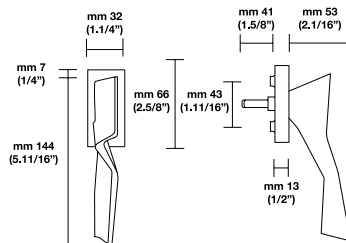

## Escutcheon options/Opzioni EP ER

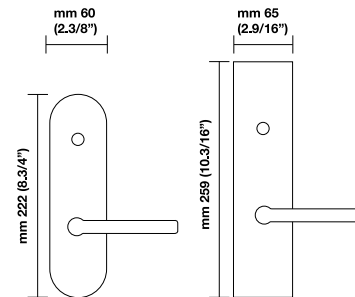

**Note** Conversions from metric to U.S. measurements are approximate.  
<sup>2</sup>Call for pricing.

## Retail Price

Finish			PGE	PCY	DMY R/L Single	ML-F ENTRY
	RP	RQ				
26	RP		\$ 865.00	\$ 886.00	\$ 427.00	\$ 1,320.00
		RQ	\$ 960.00	\$ 987.00	\$ 484.00	\$ 1,440.00
26D	RP		\$ 869.00	\$ 894.00	\$ 429.00	\$ 1,320.00
		RQ	\$ 977.00	\$ 1,009.00	\$ 497.00	\$ 1,440.00

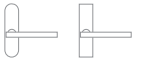
Finish			PGE	PCY	DMY R/L Single	DMY R/L Pair	ML-F ENTRY
	EP	ER					
26	EP		\$ 1,000.00	\$ 1,020.00	\$ 500.00	\$ 950.00	\$ 1,280.00
		ER	\$ 1,050.00	\$ 1,060.00	\$ 520.00	\$ 990.00	\$ 1,310.00
26D	EP		\$ 1,000.00	\$ 1,020.00	\$ 500.00	\$ 950.00	\$ 1,280.00
		ER	\$ 1,050.00	\$ 1,060.00	\$ 520.00	\$ 990.00	\$ 1,310.00

# H 359 Serie SOM New York Duemilasette **Fusital** design Skidmore, Owings & Merrill

Maniglie d'autore

## Matching elements/Coordinato

- Pg 88** Mortise lock functions
- Pg 98** Deadbolts/Privacy Bolts
- Pg 104** Escutcheons with deadbolts
- Pg 109** Multi-Point Trim functions





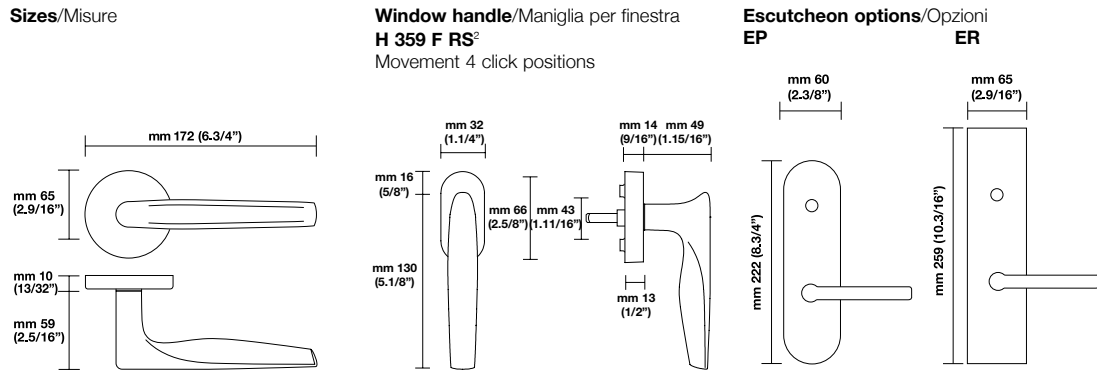







## Sizes/Misure



**Note** Conversions from metric to U.S. measurements are approximate.  
<sup>2</sup>Call for pricing.

## Retail Price

Finish			PGE	PCY	DMY R/L Single	ML-F ENTRY
	14	<b>RP</b>	\$ 480.00	\$ 494.00	\$ 231.00	\$ 960.00
	15	<b>RP</b>	\$ 484.00	\$ 497.00	\$ 231.00	\$ 960.00
	26	<b>RP</b>	\$ 424.00	\$ 435.00	\$ 202.00	\$ 960.00
	26D	<b>RP</b>	\$ 446.00	\$ 459.00	\$ 213.00	\$ 960.00

Finish			PGE	PCY	DMY R/L Single	DMY R/L Pair	ML-F ENTRY
	15	<b>EP</b>	\$ 650.00	\$ 660.00	\$ 320.00	\$ 600.00	\$ 920.00
		<b>ER</b>	\$ 680.00	\$ 690.00	\$ 340.00	\$ 640.00	\$ 950.00
	26	<b>EP</b>	\$ 650.00	\$ 660.00	\$ 320.00	\$ 600.00	\$ 920.00
		<b>ER</b>	\$ 680.00	\$ 690.00	\$ 340.00	\$ 640.00	\$ 950.00
	26D	<b>EP</b>	\$ 650.00	\$ 660.00	\$ 320.00	\$ 600.00	\$ 920.00
		<b>ER</b>	\$ 680.00	\$ 690.00	\$ 340.00	\$ 640.00	\$ 950.00



# H 361 Serie AC4 Duemilasei

design Antonio Citterio with Toan Nguyen

Material Nikrall Zamak Alloy UNI 3717/Materiale Nikrall Lega Zama UNI 3717

## Matching elements/Coordinato

- Pg 88** Mortise lock functions
- Pg 98** Deadbolts/Privacy Bolts
- Pg 104** Escutcheons with deadbolts
- Pg 109** Multi-Point Trim functions

## Rosette options/Opzioni RP

mm 65  
(2.9/16")

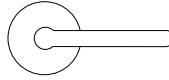

## Sizes/Misure

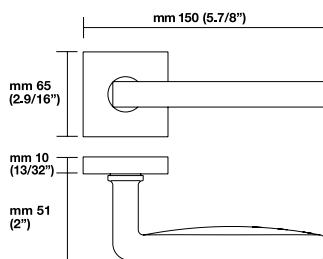

## Window handle/Maniglia per finestra H 361 F RS<sup>2</sup> Movement 4 click positions

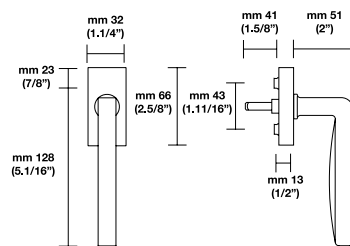



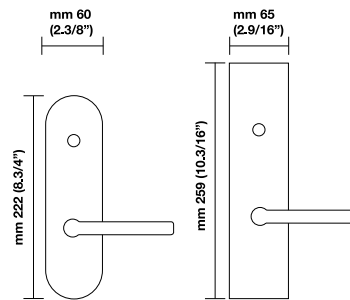







## Escutcheon options/Opzioni EP ER



**Note** Conversions from metric to U.S. measurements are approximate.  
<sup>2</sup>Call for pricing.

## Retail Price

Finish				PGE	PCY	DMY R/L Single	ML-F ENTRY
	14	RP		\$ 365.00	\$ 388.00	\$ 177.00	\$ 870.00
		RQ		\$ 484.00	\$ 499.00	\$ 243.00	\$ 980.00
	15	RP		\$ 366.00	\$ 393.00	\$ 177.00	\$ 870.00
		RQ		\$ 473.00	\$ 487.00	\$ 240.00	\$ 980.00
	26	RP		\$ 324.00	\$ 347.00	\$ 155.00	\$ 870.00
		RQ		\$ 427.00	\$ 440.00	\$ 211.00	\$ 980.00
	26D	RP		\$ 334.00	\$ 361.00	\$ 162.00	\$ 870.00
		RQ		\$ 449.00	\$ 462.00	\$ 227.00	\$ 980.00

Finish				PGE	PCY	DMY R/L Single	DMY R/L Pair	ML-F ENTRY
	15	EP		\$ 540.00	\$ 550.00	\$ 260.00	\$ 480.00	\$ 820.00
		ER		\$ 580.00	\$ 590.00	\$ 290.00	\$ 530.00	\$ 850.00
	26	EP		\$ 540.00	\$ 550.00	\$ 260.00	\$ 480.00	\$ 820.00
		ER		\$ 580.00	\$ 590.00	\$ 290.00	\$ 530.00	\$ 850.00
	26D	EP		\$ 540.00	\$ 550.00	\$ 260.00	\$ 480.00	\$ 820.00
		ER		\$ 580.00	\$ 590.00	\$ 290.00	\$ 530.00	\$ 850.00

# H 362 Serie CC Duemilanove

design Carlo Colombo



## Matching elements/Coordinato

- Pg 88** Mortise lock functions
- Pg 98** Deadbolts/Privacy Bolts
- Pg 104** Escutcheons with deadbolts
- Pg 109** Multi-Point Trim functions



## Sizes/Misure

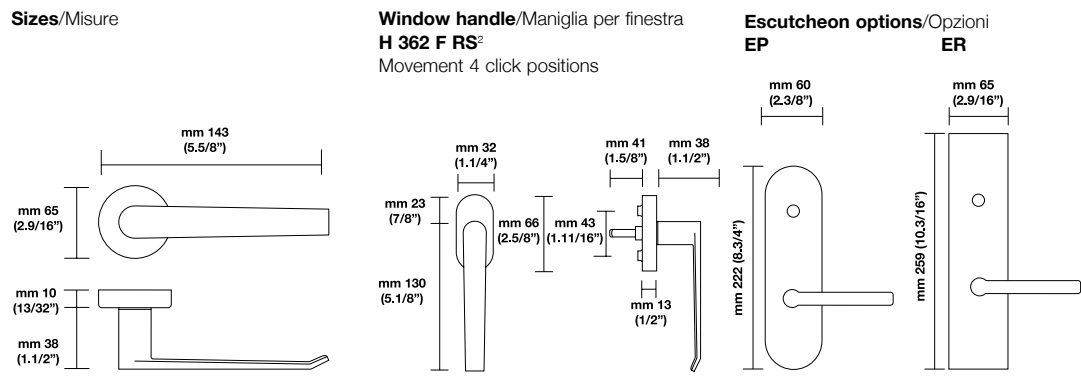

**Note** Conversions from metric to U.S. measurements are approximate.  
<sup>2</sup>Call for pricing.

## Retail Price

Finish		PGE	PCY	DMY R/L Single	DMY R/L Pair	ML-F ENTRY
26	RP	\$ 382.00	\$ 399.00	\$ 180.00		\$ 870.00
	26D	\$ 393.00	\$ 414.00	\$ 186.00		\$ 870.00
26	EP	\$ 540.00	\$ 550.00	\$ 260.00	\$ 480.00	\$ 820.00
	ER	\$ 580.00	\$ 590.00	\$ 290.00	\$ 530.00	\$ 850.00
26D	EP	\$ 540.00	\$ 550.00	\$ 260.00	\$ 480.00	\$ 820.00
	ER	\$ 580.00	\$ 590.00	\$ 290.00	\$ 530.00	\$ 850.00

# H 363 Serie DC Duemilanove

design David Chipperfield

## Matching elements/Coordinato

- Pg 88** Mortise lock functions
- Pg 98** Deadbolts/Privacy Bolts
- Pg 104** Escutcheons with deadbolts
- Pg 109** Multi-Point Trim functions



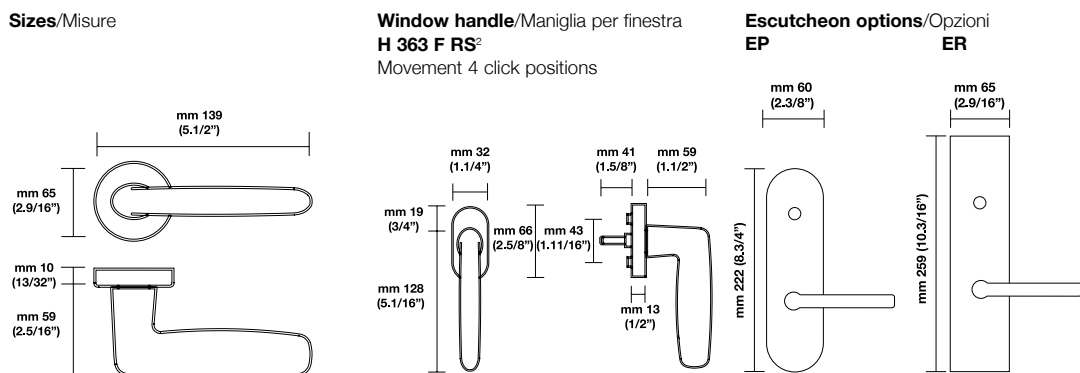

## Sizes/Misure





**Note** Conversions from metric to U.S. measurements are approximate.

<sup>2</sup>Call for pricing.

## Retail Price

Finish			PGE	PCY	DMY R/L Single	ML-F ENTRY
26	RP		\$ 393.00	\$ 415.00	\$ 186.00	\$ 870.00
26D	RP		\$ 398.00	\$ 425.00	\$ 187.00	\$ 870.00

Finish			PGE	PCY	DMY R/L Single	DMY R/L Pair	ML-F ENTRY
26	EP		\$ 540.00	\$ 550.00	\$ 260.00	\$ 480.00	\$ 820.00
	ER		\$ 580.00	\$ 590.00	\$ 290.00	\$ 530.00	\$ 850.00
26D	EP		\$ 540.00	\$ 550.00	\$ 260.00	\$ 480.00	\$ 820.00
	ER		\$ 580.00	\$ 590.00	\$ 290.00	\$ 530.00	\$ 850.00

# H 364 Serie MB Duemilanove

design Mario Bellini



## Matching elements/Coordinato

- Pg 88** Mortise lock functions
- Pg 98** Deadbolts/Privacy Bolts
- Pg 104** Escutcheons with deadbolts
- Pg 109** Multi-Point Trim functions

## Rosette options/Opzioni

**RP**  
mm 65  
(2.9/16")

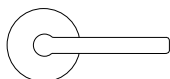

European version rosette

## Sizes/Misure

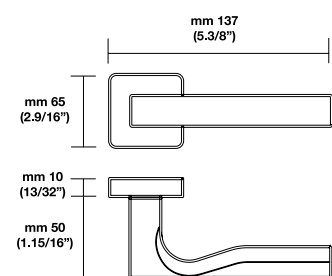

## Window handle/Maniglia per finestra

**H 364 F RS<sup>2</sup>**  
Movement 4 click positions

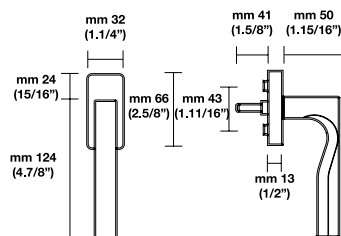





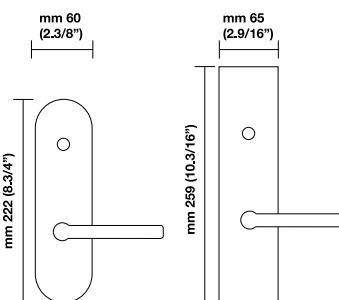



## Escutcheon options/Opzioni

**EP** **ER**



**Note** Conversions from metric to U.S. measurements are approximate.  
<sup>2</sup>Call for pricing.

## Retail Price

Finish	 	PGE	PCY	DMY R/L Single	DMY R/L Pair	ML-F ENTRY
	<b>RP</b>	\$ 395.00	\$ 415.00	\$ 186.00		\$ 870.00
	<b>RQ</b>	\$ 489.00	\$ 517.00	\$ 246.00		\$ 980.00
	<b>RP</b>	\$ 398.00	\$ 424.00	\$ 188.00		\$ 870.00
	<b>RQ</b>	\$ 504.00	\$ 530.00	\$ 258.00		\$ 980.00
Finish	 	PGE	PCY	DMY R/L Single	DMY R/L Pair	ML-F ENTRY
	<b>EP</b>	\$ 540.00	\$ 550.00	\$ 260.00	\$ 480.00	\$ 820.00
	<b>ER</b>	\$ 580.00	\$ 590.00	\$ 290.00	\$ 530.00	\$ 850.00
	<b>EP</b>	\$ 540.00	\$ 550.00	\$ 260.00	\$ 480.00	\$ 820.00
	<b>ER</b>	\$ 580.00	\$ 590.00	\$ 290.00	\$ 530.00	\$ 850.00

# H 367 Serie GV Duemilanove

design Giancarlo Vegni

## Matching elements/Coordinato

- Pg 88** Mortise lock functions
- Pg 98** Deadbolts/Privacy Bolts
- Pg 104** Escutcheons with deadbolts
- Pg 109** Multi-Point Trim functions

## Rosette options/Opzioni RP

mm 65  
(2.9/16")

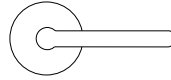

## Sizes/Misure

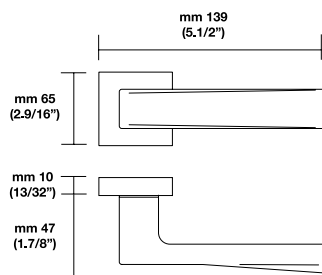

## Window handle/Maniglia per finestra H 367 F RS<sup>2</sup> Movement 4 click positions

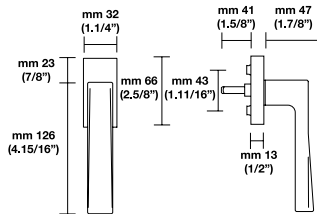

## Escutcheon options/Opzioni EP ER

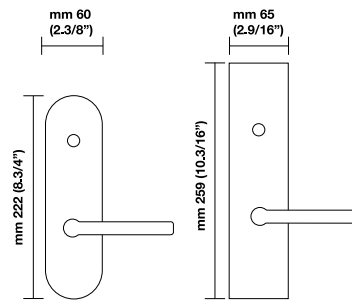

**Note** Conversions from metric to U.S. measurements are approximate.  
<sup>2</sup>Call for pricing.

## Retail Price

Finish		PGE	PCY	DMY R/L Single	DMY R/L Pair	ML-F ENTRY
26	RP	\$ 398.00	\$ 417.00	\$ 188.00		\$ 870.00
	RQ	\$ 489.00	\$ 517.00	\$ 246.00		\$ 980.00
26D	RP	\$ 403.00	\$ 424.00	\$ 190.00		\$ 870.00
	RQ	\$ 504.00	\$ 530.00	\$ 258.00		\$ 980.00
Finish		PGE	PCY	DMY R/L Single	DMY R/L Pair	ML-F ENTRY
26	EP	\$ 540.00	\$ 550.00	\$ 260.00	\$ 480.00	\$ 820.00
	ER	\$ 580.00	\$ 590.00	\$ 290.00	\$ 530.00	\$ 850.00
26D	EP	\$ 540.00	\$ 550.00	\$ 260.00	\$ 480.00	\$ 820.00
	ER	\$ 580.00	\$ 590.00	\$ 290.00	\$ 530.00	\$ 850.00

# H 368 Serie CA Duemilanove

design Studio Cerri & Associati

## Matching elements/Coordinato

- Pg 88** Mortise lock functions
- Pg 98** Deadbolts/Privacy Bolts
- Pg 104** Escutcheons with deadbolts
- Pg 109** Multi-Point Trim functions



## Sizes/Misure

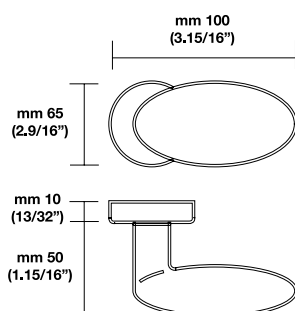

## Window handle/Maniglia per finestra H 368 F RS<sup>2</sup>

Movement 4 click positions

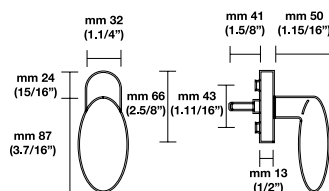



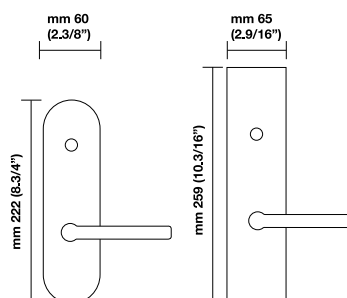





## Escutcheon options/Opzioni EP ER



**Note** Conversions from metric to U.S. measurements are approximate.

<sup>2</sup>Call for pricing.

## Retail Price

Finish			PGE	PCY	DMY R/L Single	DMY R/L Pair	ML-F ENTRY
	26	<b>RP</b>	\$ 363.00	\$ 383.00	\$ 171.00		\$ 870.00
	26D	<b>RP</b>	\$ 376.00	\$ 397.00	\$ 177.00		\$ 870.00
Finish			PGE	PCY	DMY R/L Single	DMY R/L Pair	ML-F ENTRY
	26	<b>EP</b>	\$ 540.00	\$ 550.00	\$ 260.00	\$ 480.00	\$ 820.00
		<b>ER</b>	\$ 580.00	\$ 590.00	\$ 290.00	\$ 530.00	\$ 850.00
	26D	<b>EP</b>	\$ 540.00	\$ 550.00	\$ 260.00	\$ 480.00	\$ 820.00
		<b>ER</b>	\$ 580.00	\$ 590.00	\$ 290.00	\$ 530.00	\$ 850.00

# H 369' Serie EG Duemilanove

design Eri Goshen

## Matching elements/Coordinato

- Pg 88** Mortise lock functions
- Pg 98** Deadbolts/Privacy Bolts
- Pg 104** Escutcheons with deadbolts
- Pg 109** Multi-Point Trim functions

## Rosette options/Opzioni RP

mm 65  
(2.9/16")

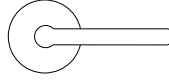

## Sizes/Misure

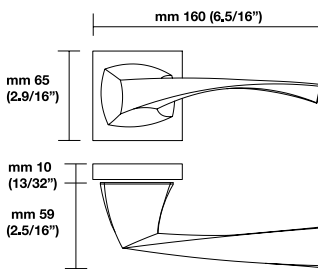

## Window handle/Maniglia per finestra H 369 F RS<sup>2</sup> Movement 4 click positions

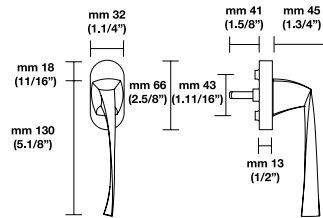

## Escutcheon options/Opzioni EP ER

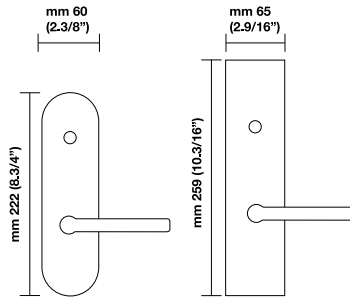

**Note** Conversions from metric to U.S. measurements are approximate.  
<sup>2</sup>Call for pricing.

## Retail Price

Finish		PGE	PCY	DMY R/L Single	ML-F ENTRY
26	<b>RP</b>	\$ 449.00	\$ 470.00	\$ 222.00	\$ 960.00
	<b>RQ</b>	\$ 576.00	\$ 597.00	\$ 297.00	\$ 1,100.00
26D	<b>RP</b>	\$ 449.00	\$ 470.00	\$ 222.00	\$ 960.00
	<b>RQ</b>	\$ 593.00	\$ 607.00	\$ 308.00	\$ 1,100.00

Finish		PGE	PCY	DMY R/L Single	DMY R/L Pair	ML-F ENTRY
26	<b>EP</b>	\$ 650.00	\$ 660.00	\$ 320.00	\$ 600.00	\$ 920.00
	<b>ER</b>	\$ 680.00	\$ 690.00	\$ 340.00	\$ 640.00	\$ 950.00
26D	<b>EP</b>	\$ 650.00	\$ 660.00	\$ 320.00	\$ 600.00	\$ 920.00
	<b>ER</b>	\$ 680.00	\$ 690.00	\$ 340.00	\$ 640.00	\$ 950.00

<sup>1</sup>Not currently in production. Available for minimum quantity per order/Details page 14

# H 370 Serie MDF Duemiladieci

design Massimiliano e Doriana Fuksas

## Matching elements/Coordinato

- Pg 88** Mortise lock functions
- Pg 98** Deadbolts/Privacy Bolts
- Pg 104** Escutcheons with deadbolts
- Pg 109** Multi-Point Trim functions

## Rosette options/Opzioni RP

mm 65  
(2.9/16")

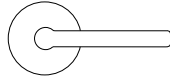

## Sizes/Misure

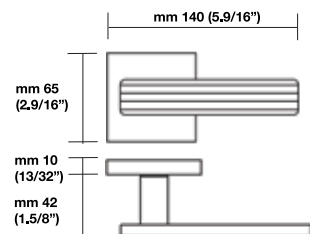

## Window handle/Maniglia per finestra H 370 F RS<sup>2</sup> Movement 4 click positions

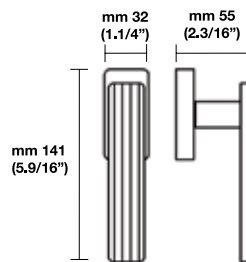

## Escutcheon options/Opzioni EP ER

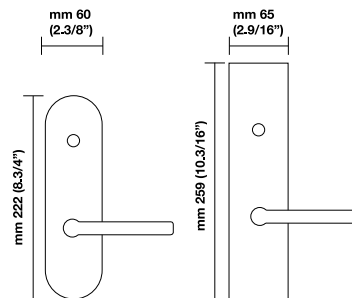

**Note** Conversions from metric to U.S. measurements are approximate.  
<sup>2</sup>Call for pricing.

## Retail Price

Finish				PGE	PCY	DMY R/L Single	ML-F ENTRY	
26	<b>RP</b>			\$ 308.00	\$ 330.00	\$ 153.00	\$ 870.00	
	<b>RQ</b>			\$ 411.00	\$ 438.00	\$ 212.00	\$ 980.00	
26D	<b>RP</b>			\$ 318.00	\$ 340.00	\$ 160.00	\$ 870.00	
	<b>RQ</b>			\$ 425.00	\$ 454.00	\$ 227.00	\$ 980.00	
Finish				PGE	PCY	DMY R/L Single	DMY R/L Pair	ML-F ENTRY
26	<b>EP</b>			\$ 540.00	\$ 550.00	\$ 260.00	\$ 480.00	\$ 820.00
	<b>ER</b>			\$ 580.00	\$ 590.00	\$ 290.00	\$ 530.00	\$ 850.00
26D	<b>EP</b>			\$ 540.00	\$ 550.00	\$ 260.00	\$ 480.00	\$ 820.00
	<b>ER</b>			\$ 580.00	\$ 590.00	\$ 290.00	\$ 530.00	\$ 850.00



# H 371 Serie LK Duemiladieci

design Leon Krier

## Matching elements/Coordinato

- Pg 88** Mortise lock functions
- Pg 98** Deadbolts/Privacy Bolts
- Pg 104** Escutcheons with deadbolts
- Pg 109** Multi-Point Trim functions



## Sizes/Misure

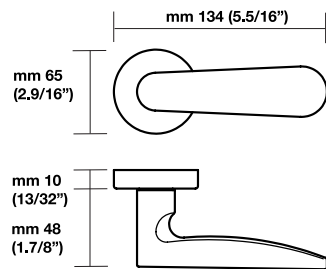

## Window handle/Maniglia per finestra H 371 F RS<sup>2</sup> Movement 4 click positions

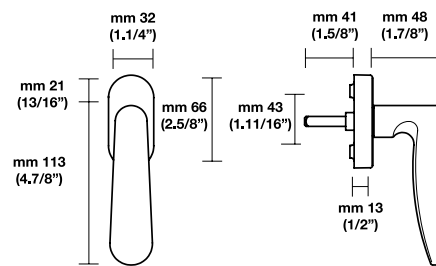



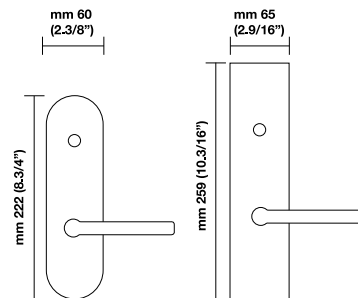

## Escutcheon options/Opzioni EP ER



**Note** Conversions from metric to U.S. measurements are approximate.  
<sup>2</sup>Call for pricing.

## Retail Price

Finish			PGE	PCY	DMY R/L Single	DMY R/L Pair	ML-F ENTRY
26	RP		\$ 452.00	\$ 474.00	\$ 227.00		\$ 960.00
26D	RP		\$ 474.00	\$ 500.00	\$ 237.00		\$ 960.00
Finish			PGE	PCY	DMY R/L Single	DMY R/L Pair	ML-F ENTRY
26	EP		\$ 650.00	\$ 660.00	\$ 320.00	\$ 600.00	\$ 920.00
		ER	\$ 680.00	\$ 690.00	\$ 340.00	\$ 640.00	\$ 950.00
26D	EP		\$ 650.00	\$ 660.00	\$ 320.00	\$ 600.00	\$ 920.00
		ER	\$ 680.00	\$ 690.00	\$ 340.00	\$ 640.00	\$ 950.00

# H 372 Serie EG Duemiladodici

design Eri Goshen

## Matching elements/Coordinato

- Pg 88** Mortise lock functions
- Pg 98** Deadbolts/Privacy Bolts
- Pg 104** Escutcheons with deadbolts
- Pg 109** Multi-Point Trim functions

## Rosette options/Opzioni RP

mm 65  
(2.9/16")

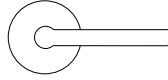

## Sizes/Misure

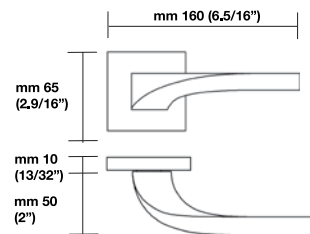

## Window handle/Maniglia per finestra H 372 F RS<sup>2</sup> Movement 4 click positions

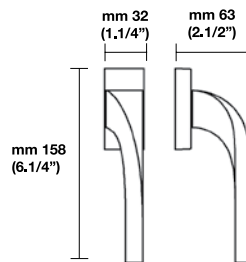

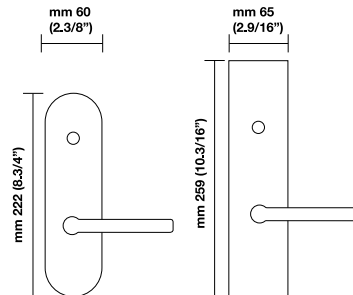

## Escutcheon options/Opzioni EP ER



**Note** Conversions from metric to U.S. measurements are approximate.  
<sup>2</sup>Call for pricing.

## Retail Price

Finish			PGE	PCY	DMY R/L Single	DMY R/L Pair	ML-F ENTRY
	26	<b>RP</b>	\$ 315.00	\$ 335.00	\$ 157.00		\$ 870.00
		<b>RQ</b>	\$ 411.00	\$ 438.00	\$ 215.00		\$ 980.00
	26D	<b>RP</b>	\$ 328.00	\$ 351.00	\$ 164.00		\$ 870.00
		<b>RQ</b>	\$ 435.00	\$ 462.00	\$ 232.00		\$ 980.00
Finish			PGE	PCY	DMY R/L Single	DMY R/L Pair	ML-F ENTRY
	26	<b>EP</b>	\$ 540.00	\$ 550.00	\$ 260.00	\$ 480.00	\$ 820.00
		<b>ER</b>	\$ 580.00	\$ 590.00	\$ 290.00	\$ 530.00	\$ 850.00
	26D	<b>EP</b>	\$ 540.00	\$ 550.00	\$ 260.00	\$ 480.00	\$ 820.00
		<b>ER</b>	\$ 580.00	\$ 590.00	\$ 290.00	\$ 530.00	\$ 850.00

# H 373' Serie DOB Duemiladodici

design Dante O. Benini e Luca Gonzo

## Matching elements/Coordinato

- Pg 88** Mortise lock functions
- Pg 98** Deadbolts/Privacy Bolts
- Pg 104** Escutcheons with deadbolts
- Pg 109** Multi-Point Trim functions

## Rosette options/Opzioni

**RQ**

mm 65  
(2.9/16")

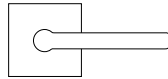

## Sizes/Misure

## Window handle/Maniglia per finestra

**H 373 F RS<sup>2</sup>**

Movement 4 click positions

## Escutcheon options/Opzioni

**EP**

**ER**

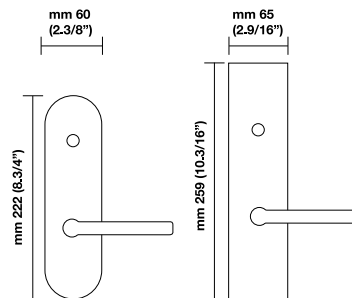
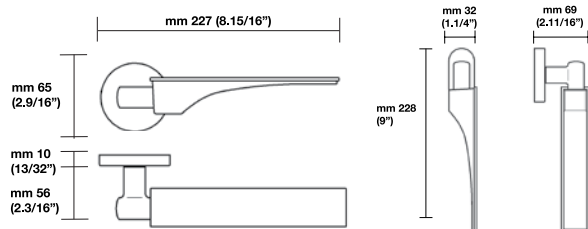

**Note** Conversions from metric to U.S. measurements are approximate.

<sup>2</sup>Call for pricing.

## Retail Price

Finish		PGE	PCY	DMY R/L Single	ML-F ENTRY	
26/16	<b>RP</b>	\$ 897.00	\$ 917.00	\$ 443.00	\$ 1,320.00	
	<b>RQ</b>	\$ 1,000.00	\$ 1,020.00	\$ 503.00	\$ 1,440.00	
Finish		PGE	PCY	DMY R/L Single	DMY R/L Pair	ML-F ENTRY
26/16	<b>EP</b>	\$ 1,000.00	\$ 1,020.00	\$ 500.00	\$ 950.00	\$ 1,280.00
	<b>ER</b>	\$ 1,050.00	\$ 1,060.00	\$ 520.00	\$ 990.00	\$ 1,310.00

<sup>1</sup>Not currently in production. Available for minimum quantity per order/Details page 14

# H 375 Serie Bassorilievo

design Fusital Workshop

## Matching elements/Coordinato

- Pg 88** Mortise lock functions
- Pg 98** Deadbolts/Privacy Bolts
- Pg 104** Escutcheons with deadbolts
- Pg 109** Multi-Point Trim functions

## Rosette options/Opzioni

**RP**

mm 65  
(2.9/16")

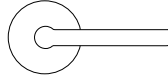

## Sizes/Misure

## Window handle/Maniglia per finestra

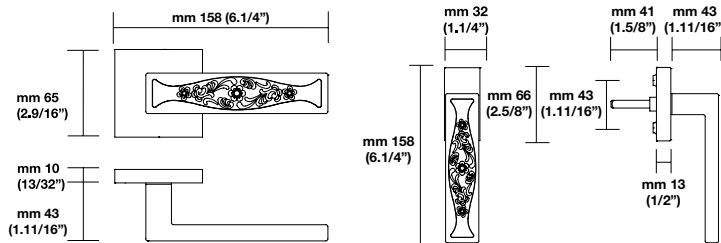

**H 375 F RS<sup>2</sup>**

Movement 4 click positions



**Note** Conversions from metric to U.S. measurements are approximate.  
<sup>2</sup>Call for pricing.

## Retail Price

Finish	 	PGE	PCY	DMY R/L Single	ML-F ENTRY
GREY	<b>RP</b>	\$ 470.00	\$ 480.00	\$ 220.00	\$ 960.00
	<b>RQ</b>	\$ 510.00	\$ 540.00	\$ 260.00	\$ 1,100.00
GREY/03	<b>RP</b>	\$ 480.00	\$ 495.00	\$ 225.00	\$ 960.00
	<b>RQ</b>	\$ 525.00	\$ 550.00	\$ 270.00	\$ 1,100.00
06M	<b>RP</b>	\$ 600.00	\$ 620.00	\$ 285.00	\$ 960.00
	<b>RQ</b>	\$ 678.00	\$ 699.00	\$ 365.00	\$ 1,100.00
06M/03	<b>RP</b>	\$ 620.00	\$ 640.00	\$ 295.00	\$ 960.00
	<b>RQ</b>	\$ 688.00	\$ 720.00	\$ 368.00	\$ 1,100.00
22M	<b>RP</b>	\$ 420.00	\$ 440.00	\$ 202.00	\$ 960.00
	<b>RQ</b>	\$ 510.00	\$ 540.00	\$ 260.00	\$ 1,100.00
22/03	<b>RP</b>	\$ 435.00	\$ 448.00	\$ 208.00	\$ 960.00
	<b>RQ</b>	\$ 530.00	\$ 550.00	\$ 270.00	\$ 1,100.00

**Note:** EP/ER available on special request only. Call for pricing.

# H 376 Serie Mercurio

design Fusital Workshop

## Matching elements/Coordinato

- Pg 88** Mortise lock functions
- Pg 98** Deadbolts/Privacy Bolts
- Pg 104** Escutcheons with deadbolts
- Pg 109** Multi-Point Trim functions

## Rosette options/Opzioni RP

mm 65  
(2.9/16")

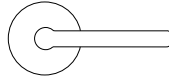

## Sizes/Misure

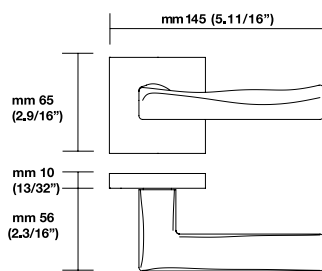

## Window handle/Maniglia per finestra H 376 F RS<sup>2</sup> Movement 4 click positions

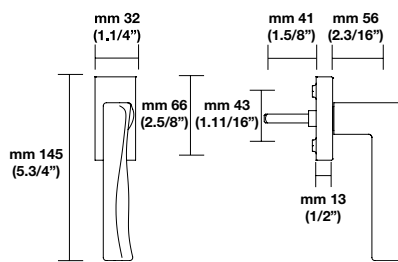



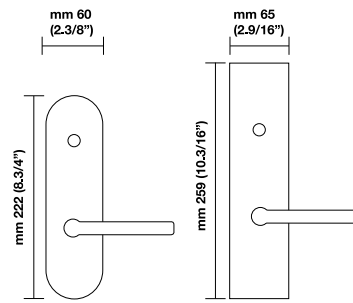

## Escutcheon options/Opzioni EP ER



**Note** Conversions from metric to U.S. measurements are approximate.  
<sup>2</sup>Call for pricing.

## Retail Price

Finish	 	PGE	PCY	DMY R/L Single	ML-F ENTRY
26	<b>RP</b>	\$ 410.00	\$ 425.00	\$ 199.00	\$ 960.00
	<b>RQ</b>	\$ 500.00	\$ 530.00	\$ 255.00	\$ 1,100.00
26/26D	<b>RP</b>	\$ 420.00	\$ 440.00	\$ 210.00	\$ 960.00
	<b>RQ</b>	\$ 530.00	\$ 555.00	\$ 280.00	\$ 1,100.00
26D	<b>RP</b>	\$ 420.00	\$ 440.00	\$ 210.00	\$ 960.00
	<b>RQ</b>	\$ 530.00	\$ 555.00	\$ 280.00	\$ 1,100.00

Finish	 	PGE	PCY	DMY R/L Single	DMY R/L Pair	ML-F ENTRY
26	<b>EP</b>	\$ 650.00	\$ 660.00	\$ 320.00	\$ 600.00	\$ 920.00
	<b>ER</b>	\$ 680.00	\$ 690.00	\$ 340.00	\$ 640.00	\$ 950.00
26/26D	<b>EP</b>	\$ 650.00	\$ 660.00	\$ 320.00	\$ 600.00	\$ 920.00
	<b>ER</b>	\$ 680.00	\$ 690.00	\$ 340.00	\$ 640.00	\$ 950.00
26D	<b>EP</b>	\$ 650.00	\$ 660.00	\$ 320.00	\$ 600.00	\$ 920.00
	<b>ER</b>	\$ 680.00	\$ 690.00	\$ 340.00	\$ 640.00	\$ 950.00

Small Square  
Rosette  
Option

# Small Square Rosette Option

design Valli Workshop

Material Brass/Materiale Ottone

Matching elements/Coordinato

Pg 98 Deadbolts/Privacy Bolts



(Shown with H 361 50 mm Rosette)

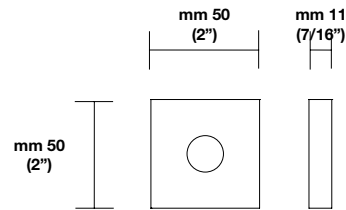

## GROUP I

H 310\*, H 315, H 317, H 326, H 327, H 330, H 334, H 338\*, H 341, H 345, H 348, H 355\*, H 361, H 362, H 363, H 364, H 367, H 368, H 370, H 372

Finish: 26-26D	Retail Price
PGE	\$ 400.00
PCY with PCY Bolt	\$ 720.00
Dummy RH or LH	\$ 190.00

## GROUP II

H 37, H 311, H 329, H 332\*, H 335\*, H 343, H 359, H 369\*, H 371, H 375, H 376

Finish: 26-26D	Retail Price
PGE	\$ 500.00
PCY with PCY Bolt	\$ 830.00
Dummy RH or LH	\$ 240.00

## GROUP III

H 350

Finish: 26-26D	Retail Price
PGE	\$ 810.00
PCY with PCY Bolt	\$ 1,130.00
Dummy RH or LH	\$ 390.00

## GROUP IV

H 352\*, H 354, H 356, H 373

Finish: 26-26D	Retail Price
PGE	\$ 860.00
PCY with PCY Bolt	\$ 1,190.00
Dummy RH or LH	\$ 420.00

## HOW TO ORDER

To order Valli&Valli small square rosette, information should be specified in the same sequence as the example given:

1.Rosette	2.Function	3.Lever/Knob	4.Finish	5.Backset	6.Handing	7.Miscellaneous
K1000 RSQ	PGE	H 311	26	2.3/8"	RH	2.1/4" thick

Privacy sets for small square rosettes are supplied with K1225 RSQ privacy bolt trim.  
Other finishes are available on special request.

\*Not currently in production. Available for minimum quantity per order/Details page 14

Conversions from metric to U.S. measurements are approximate.

Handsets





(Shown with H 1044 Door Lever)

**Sizes/Misure**

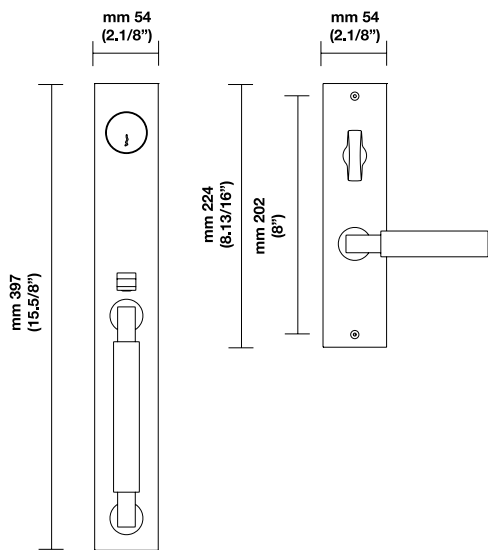

**ML TP F Entry Handleset**

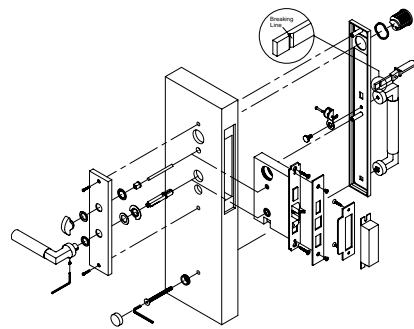



# K 1810 Entry handleset with interior trim designs



Other interior trims are available. Please refer to Valli&Valli Door levers catalog.

Handlesets have your choice of interior lever. Choose one of the groups below.



**GROUP I** H 310\*, H 315, H 317, H 326, H 327, H 330, H 334, H 338\*, H 341, H 345, H 348, H 355\*, H 361, H 362, H 363, H 364, H 367, H 368, H 370, H 372

		Retail Price	
		Entry/ENT	Dummy Set/ FD
	15	\$1,230.00	\$ 620.00
	26	\$1,200.00	\$ 610.00
	26D	\$1,230.00	\$ 620.00



**GROUP II** H 37, H 311, H 329, H 332\*, H 335\*, H 343, H 359, H 369\*, H 371, H 376

		Retail Price	
		Entry/ENT	Dummy Set/ FD
	15	\$1,280.00	\$ 680.00
	26	\$1,250.00	\$ 670.00
	26D	\$1,280.00	\$ 680.00

**GROUP III** H 350

		Retail Price	
		Entry/ENT	Dummy Set/ FD
	15	\$1,420.00	\$ 830.00
	26	\$1,400.00	\$ 820.00
	26D	\$1,420.00	\$ 830.00

**GROUP IV** H 352\*, H 354, H 356, H 373

		Retail Price	
		Entry/ENT	Dummy Set/ FD
	15	\$1,450.00	\$ 870.00
	26	\$1,420.00	\$ 850.00
	26D	\$1,450.00	\$ 870.00

## HOW TO ORDER ENTRY HANDLESET

To order Valli&Valli products, information should be specific in the same sequence as the example given below:

**1.Handleset**   **2.Function**   **3.Finish**   **4.Handing**   **5.Backset**   **6.Misc.**   **7.Int. Lever**   **8.Int. Lever Finish**  
 K1810 ENT   MLTP-F   15   RH   2-1/2"   2-1/4" thick door   H 311   15

Other finishes are available on special request.

\*Not currently in production. Available for minimum quantity per order/Details page 14

Door pulls/  
Maniglioni

# K 352 Serie RM Novantotto

design Richard Meier

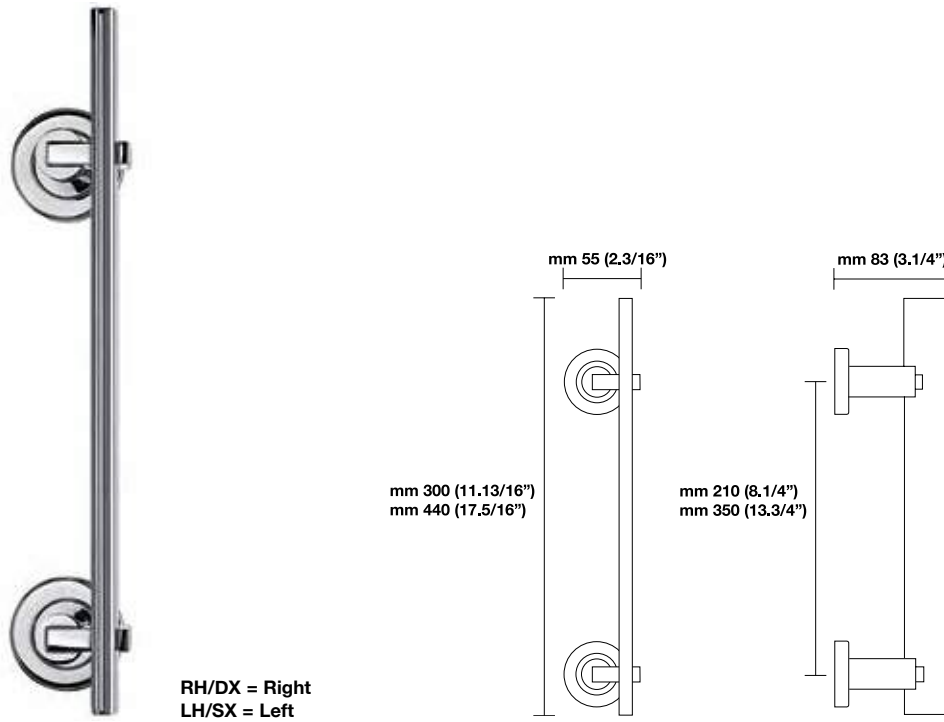

RH/DX = Right  
LH/SX = Left

## K 352 RH/LH

Finish	Size	Dimension	Center to center $\diamond\diamond$	Retail price
26	210	mm 300x55x83 [11.13/16"x2.3/16"x3.1/4"]	mm 210 [8.1/4"]	\$ 459.00
	350	mm 440x55x83 [17.5/16"x2.3/16"x3.1/4"]	mm 350 [13.3/4"]	\$ 541.00

# K 353 Serie RB Novantacinque

design Taller Design Ricardo Bofill

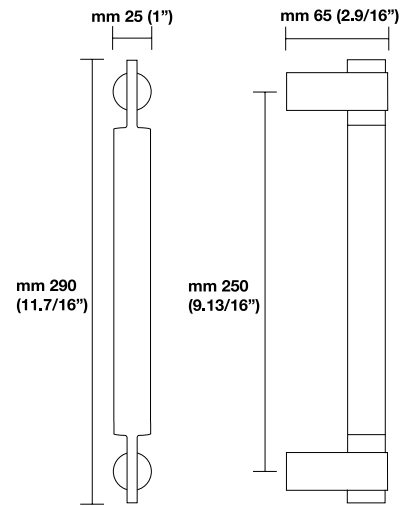

## K 353 SINGLE

Finish	Size	Dimension	Center to center ✧✧	Retail price
03/03D	250	mm 290x25x65 [11.7/16"x1"x2.9/16"]	mm 250 [9.13/16"]	\$ 510.00
26/26D	250	mm 290x25x65 [11.7/16"x1"x2.9/16"]	mm 250 [9.13/16"]	\$ 432.00

## K 353/K 353 S BACK TO BACK

Finish	Size	Dimension	Center to center ✧✧	Retail price
03/03D	250	mm 290x25x65 [11.7/16"x1"x2.9/16"]	mm 250 [9.13/16"]	\$ 1,076.00
26/26D	250	mm 290x25x65 [11.7/16"x1"x2.9/16"]	mm 250 [9.13/16"]	\$ 918.00

Complete with fixing systems for single mounting and pairs on wood and glass.

# K 356 Serie JP Duemila

design John Pawson

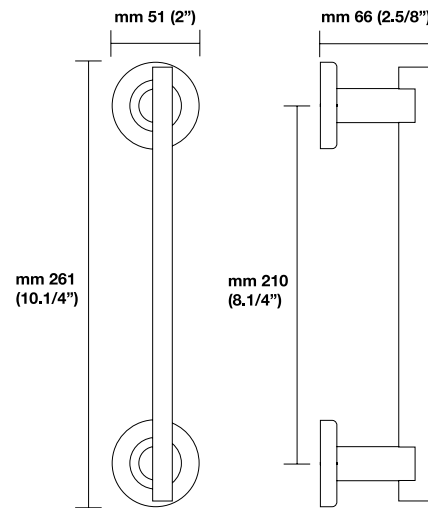

Finish	Dimension	Center to center ⇄	Retail price
● 26	mm 261x51x66 [10.1/4"x2"x2.5/8"]	mm 210 [8.1/4"]	\$ 479.00
● 26D	mm 261x51x66 [10.1/4"x2"x2.5/8"]	mm 210 [8.1/4"]	\$ 463.00

Complete with fixing systems for single mounting and pairs on wood and glass.

# K 358 Serie CA Duemiladue

design Cerri&Associati

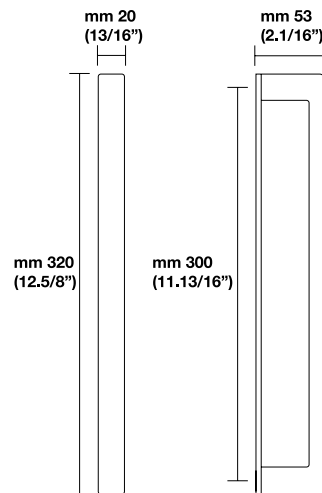

## K 358 SINGLE

Finish	Dimension	Center to center $\diamond\diamond$	Retail price
26	mm 320x20x53 [12.5/8"x13/16"x2.1/16"]	mm 300 [11.13/16"]	\$ 478.00
26D	mm 320x20x53 [12.5/8"x13/16"x2.1/16"]	mm 300 [11.13/16"]	\$ 502.00

## K 358/K 358 S BACK TO BACK

Finish	Dimension	Center to center $\diamond\diamond$	Retail price
26	mm 320x20x53 [12.5/8"x13/16"x2.1/16"]	mm 300 [11.13/16"]	\$ 995.00
26D	mm 320x20x53 [12.5/8"x13/16"x2.1/16"]	mm 300 [11.13/16"]	\$ 1,043.00

Complete with fixing systems for single mounting and pairs on wood and glass.

# K 359 Serie ODBC Duemiladue

design Odile Decq-Benoît Cornette

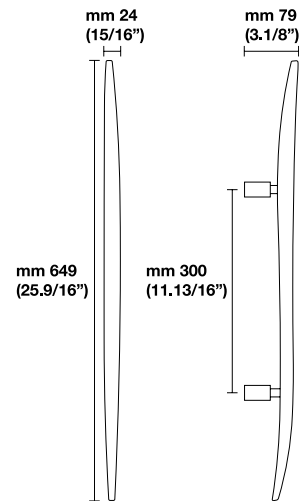

Finish	Dimension	Center to center $\diamond\diamond$	Retail price
26	mm 649x24x79 [25.9/16"x15/16"x3.1/8"]	mm 300 [11.13/16"]	\$ 1,570.00
26D	mm 649x24x79 [25.9/16"x15/16"x3.1/8"]	mm 300 [11.13/16"]	\$ 1,643.00

**Complete with fixing systems for single mounting and pairs on wood and glass.**  
Available back to back on special request. Call for pricing.



# K 368 Serie AC4 Duemilasei

design Antonio Citterio with Toan Nguyen

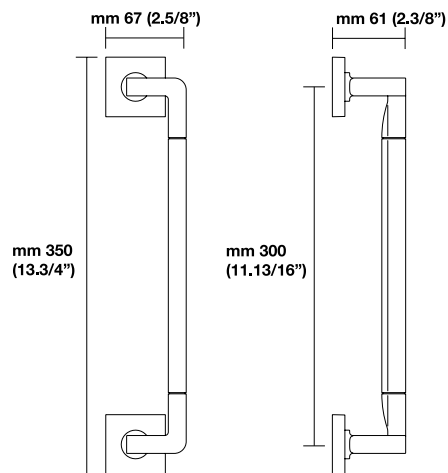

## K 368 SINGLE

Finish	Size	Dimension	Center to center ✧✧	Retail price
26	300	mm 350x67x61 [13.3/4"x2.5/8"x2.3/8"]	mm 300 [11.13/16"]	\$ 559.00
26D	300	mm 350x67x61 [13.3/4"x2.5/8"x2.3/8"]	mm 300 [11.13/16"]	\$ 588.00

## K 368/K 368 S BACK TO BACK

Finish	Size	Dimension	Center to center ✧✧	Retail price
26	300	mm 350x67x61 [13.3/4"x2.5/8"x2.3/8"]	mm 300 [11.13/16"]	\$ 1,157.00
26D	300	mm 350x67x61 [13.3/4"x2.5/8"x2.3/8"]	mm 300 [11.13/16"]	\$ 1,214.00





Complete with fixing systems for single mounting and pairs on wood and glass.

Pocket doors/  
Maniglie  
per incasso

# K 3012 Serie AC3 Duemilaquattro

design Antonio Citterio with Toan Nguyen



K 3012 PRIVACY		Retail price	
Finish	Length x Width	1.3/4"	1.3/8"
 14	mm 60x60x13 [2.3/8"x2.3/8"x1/2"]	\$ 341.00	\$ 392.00
 15	mm 60x60x13 [2.3/8"x2.3/8"x1/2"]	\$ 341.00	\$ 392.00
 26	mm 60x60x13 [2.3/8"x2.3/8"x1/2"]	\$ 301.00	\$ 342.00
 26D	mm 60x60x13 [2.3/8"x2.3/8"x1/2"]	\$ 316.00	\$ 356.00

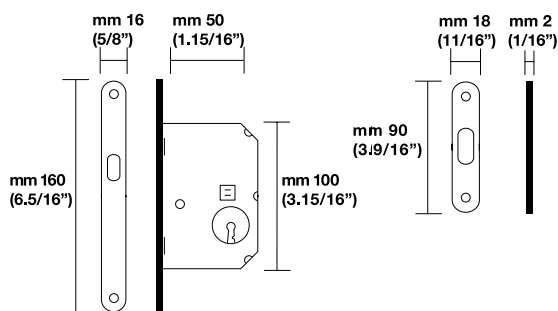
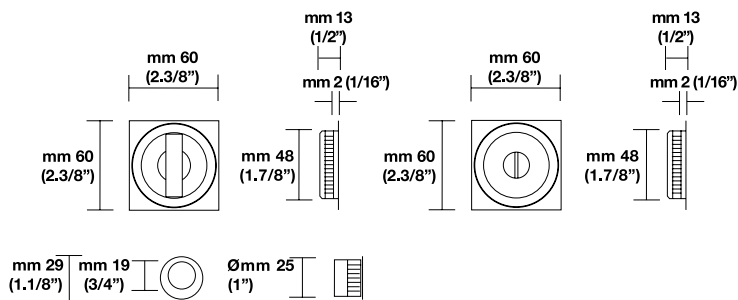

## NOTE

Please specify door thickness.

Privacy flush pulls accommodate 1.3/4" and 1.3/8".

1.3/8" require minimum pocket width 2.1/16". Spacer will add 1/8" to surface of both side of the door.

**Pocket door kit with thumb turn complete with lock and recessed finger pull.**

Split finishes available. Add \$150.00 list to the highest priced finish used.





Satin nickel: Face/Strike Satin Chrome

Polish nickel: Face/Strike Chrome

# K 3014 Serie AC3 Duemilaquattro

design Antonio Citterio with Toan Nguyen



	<b>K 3014</b>		
	<b>Finish</b>	<b>Length x Width</b>	<b>Retail price</b>
	14	mm 60x60x13 [2.3/8"x2.3/8"x1/2"]	\$ 175.00
	15	mm 60x60x13 [2.3/8"x2.3/8"x1/2"]	\$ 175.00
	26	mm 60x60x13 [2.3/8"x2.3/8"x1/2"]	\$ 196.00
	26D	mm 60x60x13 [2.3/8"x2.3/8"x1/2"]	\$ 205.00

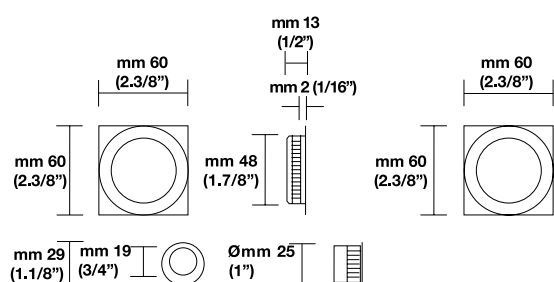

#### NOTE

Flush pulls accommodate 1.3/8" and 1.3/4" door thickness.

**Pocket door kit with thumb turn complete with lock and recessed finger pull.**

Split finishes available. Add \$150.00 list to the highest priced finish used.

Conversions from metric to U.S. measurements are approximate.





## The material: stainless steel Il materiale: acciaio inossidabile

---

### Stainless Steel, the future

The handle is an integral part of furnishing decor with a precise aesthetic and functional use. However, in the majority of cases it remains an anonymous object. Fusital was established in 1976 with an important objective: to bring together function and aesthetics, technical innovation and form through collaboration with well-known names in architecture and design. Based on this philosophy, Fusital has decided to expand the range by entering the Stainless Steel market, bringing to this field the creativity and innovation that characterizes its production. Fusital uses Chrome Nickel Molybdenum Stainless Steel, which is maintenance-free and highly resistant to corrosion, rust and fire. Fusital Stainless Steel products have been conceived and designed bearing in mind the special characteristics of this material, interpreting these with sensitivity and taste, confirming the tradition of the Fusital trade-mark.

---

### Un futuro d'Acciaio Inossidabile

La maniglia è parte integrante dell'arredamento di ogni ambiente, assolve a una precisa funzione d'uso oltre che estetica; eppure non di rado è un oggetto anonimo. La Fusital è nata nel 1976 proprio con questo obiettivo: coniugare funzionalità ed estetica, design e tecnica, avvalendosi della collaborazione di importanti nomi dell'architettura e del design. Proseguendo con questa filosofia, Fusital amplia la propria gamma entrando nel settore dell'acciaio inossidabile, portando anche in questo campo la creatività e l'innovazione che contraddistinguono la propria produzione. Fusital utilizza esclusivamente Acciaio inossidabile al Cromo Nichel Molibdeno, esente da manutenzione, caratterizzato da un'ottima resistenza alla corrosione, alla ruggine e al fuoco. I prodotti Fusital in Acciaio inossidabile per l'arredamento e l'edilizia, sono pensati e disegnati coerentemente alle caratteristiche di questo materiale, interpretano con sensibilità i percorsi del gusto, confermando la tradizione del marchio Fusital.

---

# Stainless Steel door levers

Door levers/  
Maniglie

---

**Austenitic Stainless Steel/**  
Acciaio Inossidabile Austenitico

## **Comparison table/** **Tabella di corrispondenza**

---

<b>U.S.A.</b>	<b>AISI</b>	<b>316 L</b>
<b>France / Francia</b>	<b>AFNOR</b>	<b>Z2 CND 17 12</b>
<b>Germany / Germania</b>	<b>DIN</b>	<b>X2 CrNiMo 17 13 2 WN 1.4404</b>
<b>Italy / Italia</b>	<b>UNI</b>	<b>X2 CrNiMo 17 12</b>
<b>Great Britian / Gran Bretagna</b>	<b>BSI</b>	<b>316 S 11</b>
<b>Sweden / Svezia</b>	<b>SIS</b>	<b>23 48</b>
<b>Japan / Japan</b>	<b>JIS</b>	<b>SUS 33</b>
<b>Russia / Russia</b>	<b>GOST</b>	<b>03 Ch17 N14 M2</b>

---

**Molybdenum**  
**Chromium**  
**Nickel Stainless Steel**

Excellent resistance to corrosion and to many aggressive chemicals.  
Low carbon content makes it resistant to intergranular corrosion.  
These characteristics make it particularly suitable for application in aggressive environments such as the chemical and petrochemical industry as well as particularly harsh climatic conditions.

---



# H 5008<sup>1</sup> Serie Himalaya

design Taller Design Ricardo Bofill

Material Stainless Steel AISI 316 L/Materiale Acciaio Inox AISI 316 L

Matching elements/Coordinato

- Pg 83** Door Pulls
- Pg 88** Mortise lock functions
- Pg 98** Deadbolts/Privacy Bolts
- Pg 104** Escutcheons with deadbolts
- Pg 109** Multi-Point Trim functions



Finish		PGE	PCY	DMY	Retail Price	
					R/L Single	ML-F ENTRY
32D	<b>RPS</b>	\$ 568.00	\$ 585.00	\$ 274.00	\$ 1,200.00	
	<b>RQS</b>	\$ 701.00	\$ 733.00	\$ 349.00	\$ 1,220.00	
	<b>RSS</b>	\$ 541.00	\$ 691.00	\$ 257.00	\$ 995.00	

Finish		PGE	PCY	DMY	Retail Price	
					R/L Single	R/L Pair
32D	<b>NES</b>	\$ 733.00	\$ 881.00	\$ 380.00	\$ 710.00	\$ 1,030.00
	<b>ERS</b>	\$ 816.00	\$ 827.00	\$ 415.00	\$ 785.00	\$ 1,060.00

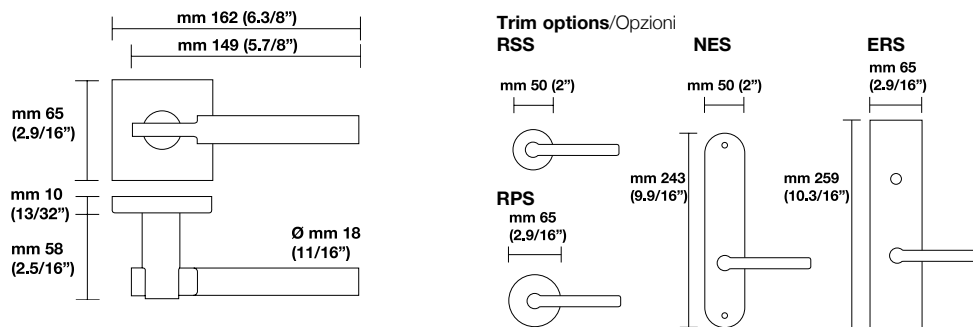

<sup>1</sup>Not currently in production. Available for minimum quantity per order/Details page 14

**NOTE**

RSS (2"-50mm rosette). RSS roses Privacy, supplied with 105 RSS Privacy Bolt. RPS/RQS/ERS (2.9/16"-65 mm) for standard 2.1/8" cross bore.  
**RSS = Trim not recommended for commercial use.** NES Specify handing. Privacy uses a Privacy Bolt.  
 NES-ERS: available only in 32D.  
 Conversions from metric to U.S. measurements are approximate.

# H 5014 Serie Bernina



design Fusital Workshop



Material Stainless Steel AISI 316 L/Materiale Acciaio Inox AISI 316 L

Matching elements/Coordinato

- Pg 88** Mortise lock functions
- Pg 98** Deadbolts/Privacy Bolts
- Pg 104** Escutcheons with deadbolts
- Pg 109** Multi-Point Trim functions



Finish	  	PGE	PCY	DMY	Retail Price	
					R/L Single	ML-F ENTRY
32	<b>RPS</b>		\$ 370.00	\$ 399.00	\$ 180.00	\$ 1,300.00
		<b>RSS</b>	\$ 334.00	\$ 521.00	\$ 151.00	\$ 1,100.00
32D	<b>RPS</b>		\$ 320.00	\$ 328.00	\$ 158.00	\$ 1,040.00
		<b>RSS</b>	\$ 285.00	\$ 434.00	\$ 130.00	\$ 830.00

Finish	 	PGE	PCY	DMY	Retail Price	
					R/L Single	R/L Pair
32D	<b>NES</b>		\$ 599.00	\$ 290.00	\$ 530.00	\$ 870.00
		<b>ERS</b>	\$ 543.00	\$ 546.00	\$ 277.00	\$ 509.00

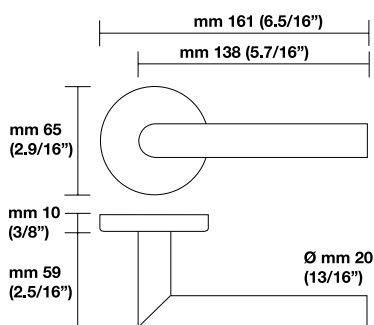

Trim options/Opzioni

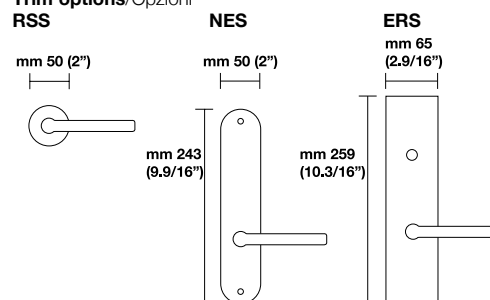

**NOTE**

RSS (2"-50mm rosette). RSS roses Privacy, supplied with 105 RSS Privacy Bolt. RPS/RQS/ERS (2.9/16"-65 mm) for standard 2.1/8" cross bore.

**RSS = Trim not recommended for commercial use.** NES Specify handing. Privacy uses a Privacy Bolt.

NES-ERS: available only in 32D.

Conversions from metric to U.S. measurements are approximate.

# H 5015 Serie K2

design Antonio Citterio

Material Stainless Steel AISI 316 L/Materiale Acciaio Inox AISI 316 L

Matching elements/Coordinato

- Pg 83** Door Pulls
- Pg 88** Mortise lock functions
- Pg 98** Deadbolts/Privacy Bolts
- Pg 104** Escutcheons with deadbolts
- Pg 109** Multi-Point Trim functions



Finish	RPS	RSS	PGE	PCY	DMY R/L Single	Retail Price
						ML-F ENTRY
32	RPS		\$ 923.00	\$ 954.00	\$ 457.00	\$ 1,710.00
		RSS	\$ 891.00	\$ 1,060.00	\$ 430.00	\$ 1,500.00
32D	RPS		\$ 733.00	\$ 743.00	\$ 355.00	\$ 1,460.00
		RSS	\$ 701.00	\$ 849.00	\$ 340.00	\$ 1,250.00

Finish	NES	ERS	PGE	PCY	DMY R/L Single	DMY R/L Pair	Retail Price
							ML-F ENTRY
32D	NES		\$ 901.00	\$ 1,035.00	\$ 500.00	\$ 950.00	\$ 1,280.00
		ERS	\$ 992.00	\$ 998.00	\$ 499.00	\$ 934.00	\$ 1,320.00

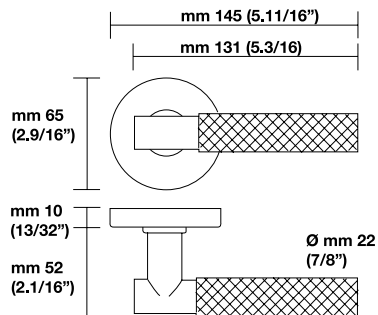

Trim options/Opzioni

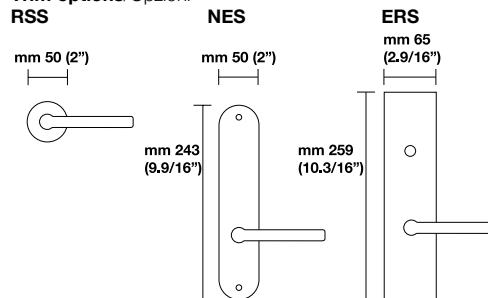

**NOTE**

RSS (2"-50mm rosette). RSS roses Privacy, supplied with 105 RSS Privacy Bolt. RPS/RQS/ERS (2.9/16"-65 mm) for standard 2.1/8" cross bore.  
**RSS = Trim not recommended for commercial use.** NES Specify handing. Privacy uses a Privacy Bolt.  
 NES-ERS: available only in 32D.  
 Conversions from metric to U.S. measurements are approximate.

# H 5015 Serie K2



design Antonio Citterio

Material Stainless Steel AISI 316 L - Leather/Materiale Acciaio Inox AISI 316 L - Pelle



Matching elements/Coordinato

- Pg 88** Mortise lock functions
- Pg 98** Deadbolts/Privacy Bolts
- Pg 104** Escutcheons with deadbolts
- Pg 109** Multi-Point Trim functions



Finish	  			PGE	PCY	DMY R/L Single	Retail Price
							ML-F ENTRY
● 32D/Black leather	<b>RPS</b>			\$ 1,115.00	\$ 1,146.00	\$ 556.00	\$ 1,820.00
		<b>RSS</b>		\$ 1,098.00	\$ 1,252.00	\$ 534.00	\$ 1,590.00

● 32D/Orange leather	<b>RPS</b>			\$ 1,115.00	\$ 1,146.00	\$ 556.00	\$ 1,820.00
		<b>RSS</b>		\$ 1,098.00	\$ 1,252.00	\$ 534.00	\$ 1,590.00

Finish	 		PGE	PCY	DMY R/L Single	DMY R/L Pair	Retail Price
● 32D/Black leather	<b>NES</b>		\$ 1,350.00	\$ 1,390.00	\$ 670.00	\$ 1,300.00	\$ 1,630.00
		<b>ERS</b>	\$ 1,400.00	\$ 1,450.00	\$ 700.00	\$ 1,350.00	\$ 1,660.00
● 32D/Orange leather	<b>NES</b>		\$ 1,350.00	\$ 1,390.00	\$ 670.00	\$ 1,300.00	\$ 1,630.00
		<b>ERS</b>	\$ 1,400.00	\$ 1,450.00	\$ 700.00	\$ 1,350.00	\$ 1,660.00

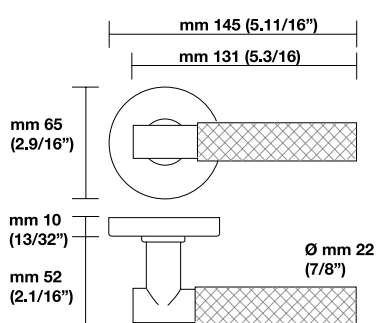

Trim options/Opzioni

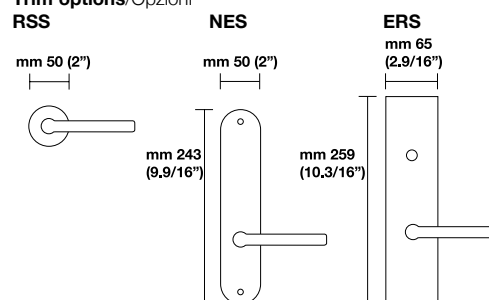

**NOTE**

RSS (2"-50mm rosette). RSS roses Privacy, supplied with 105 RSS Privacy Bolt. RPS/RQS/ERS (2.9/16"-65 mm) for standard 2.1/8" cross bore.

**RSS = Trim not recommended for commercial use.** NES Specify handing. Privacy uses a Privacy Bolt.

NES-ERS: available only in 32D.

Conversions from metric to U.S. measurements are approximate.

# H 5017 Serie Gottardo

design Hans Kollhoff

Material Stainless Steel AISI 316 L/Materiale Acciaio Inox AISI 316 L

Matching elements/Coordinato

- Pg 88** Mortise lock functions
- Pg 98** Deadbolts/Privacy Bolts
- Pg 104** Escutcheons with deadbolts
- Pg 109** Multi-Point Trim functions



Finish	PGE	PCY	Retail Price	
			DMY R/L Single	ML-F ENTRY
32	RPS		\$ 998.00	\$ 1,710.00
	RSS		\$ 959.00	\$ 1,500.00
32D	RPS		\$ 783.00	\$ 1,460.00
	RSS		\$ 748.00	\$ 1,250.00

Finish	PGE	PCY	Retail Price	
			DMY R/L Single	DMY R/L Pair
32D	NES	\$ 934.00	\$ 500.00	\$ 950.00
	ERS	\$ 1,014.00	\$ 515.00	\$ 982.00

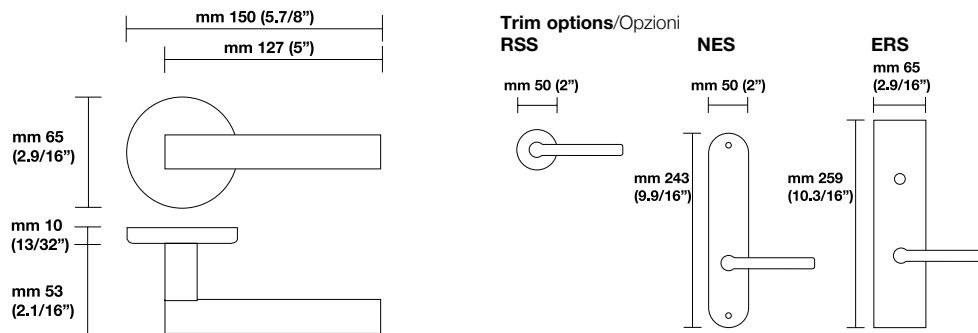

**NOTE**

RSS (2"-50mm rosette). RSS roses Privacy, supplied with 105 RSS Privacy Bolt. RPS/RQS/ERS (2.9/16"-65 mm) for standard 2.1/8" cross bore.  
**RSS = Trim not recommended for commercial use.** NES Specify handing. Privacy uses a Privacy Bolt.  
 NES-ERS: available only in 32D.  
 Conversions from metric to U.S. measurements are approximate.

# H 5021 Serie Arrowhead

design Frank O. Gehry

Material Stainless Steel AISI 316 L/Materiale Acciaio Inox AISI 316 L

Matching elements/Coordinato

- Pg 88** Mortise lock functions
- Pg 98** Deadbolts/Privacy Bolts
- Pg 104** Escutcheons with deadbolts
- Pg 109** Multi-Point Trim functions



Finish	PGE	PCY	Retail Price		
			DMY R/L Single	ML-F ENTRY	
32	RPS	\$ 1,544.00	\$ 1,576.00	\$ 755.00	\$ 2,100.00
	RQS	\$ 1,697.00	\$ 1,740.00	\$ 854.00	\$ 2,300.00
	RSS	\$ 1,490.00	\$ 1,676.00	\$ 729.00	\$ 1,850.00
32D	RPS	\$ 1,208.00	\$ 1,221.00	\$ 589.00	\$ 1,820.00
	RQS	\$ 1,335.00	\$ 1,369.00	\$ 661.00	\$ 1,950.00
	RSS	\$ 1,170.00	\$ 1,313.00	\$ 568.00	\$ 1,590.00

Finish	PGE	PCY	Retail Price			
			DMY R/L Single	DMY R/L Pair	ML-F ENTRY	
32D	NES	\$ 1,350.00	\$ 1,390.00	\$ 670.00	\$ 1,300.00	\$ 1,630.00
	ERS	\$ 1,427.00	\$ 1,433.00	\$ 720.00	\$ 1,401.00	\$ 1,660.00

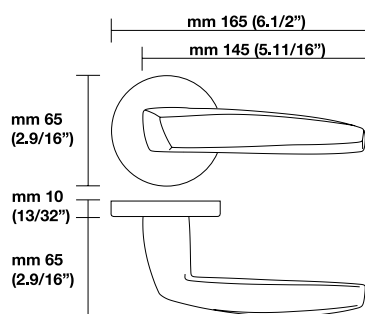

Trim options/Opzioni

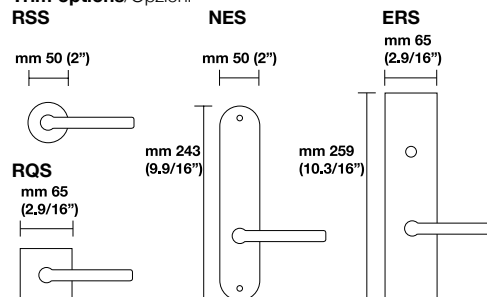

**NOTE**

RSS (2"-50mm rosette). RSS roses Privacy, supplied with 105 RSS Privacy Bolt. RPS/RQS/ERS (2.9/16"-65 mm) for standard 2.1/8" cross bore.

**RSS = Trim not recommended for commercial use.** NES Specify handing. Privacy uses a Privacy Bolt.

NES-ERS: available only in 32D.

Conversions from metric to U.S. measurements are approximate.

Door knobs/  
Pomoli

# K 5301

design Fusital Workshop

Material Stainless Steel AISI 316 L/Materiale Acciaio Inox AISI 316 L

Matching elements/Coordinato

- Pg 88** Mortise lock functions
- Pg 98** Deadbolts/Privacy Bolts
- Pg 104** Escutcheons with deadbolts



Finish		PGE	PCY	DMY R/L Single	Retail Price	
					ML-F ENTRY	
32	<b>RPS</b>		\$ 585.00	\$ 615.00	\$ 289.00	\$ 1,450.00
	<b>RSS</b>		\$ 546.00	\$ 733.00	\$ 260.00	\$ 1,245.00
32D	<b>RPS</b>		\$ 467.00	\$ 478.00	\$ 223.00	\$ 1,200.00
	<b>RSS</b>		\$ 435.00	\$ 585.00	\$ 210.00	\$ 995.00

Finish		PGE	PCY	DMY R/L Single	DMY R/L Pair	Retail Price	
						ML-F ENTRY	
32D	<b>NES</b>	\$ 700.00	\$ 760.00	\$ 350.00	\$ 680.00	\$ 1,030.00	
	<b>ERS</b>	\$ 750.00	\$ 770.00	\$ 380.00	\$ 710.00	\$ 1,060.00	

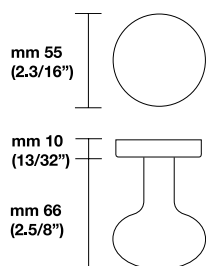

Trim options/Opzioni

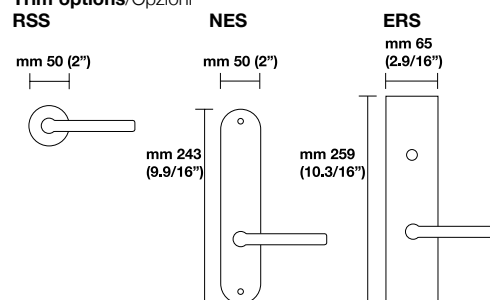

**NOTE**

RSS (2"-50mm rosette). RSS roses Privacy, supplied with 105 RSS Privacy Bolt. RPS/RQS/ERS (2.9/16"-65 mm) for standard 2.1/8" cross bore.

**RSS = Trim not recommended for commercial use.** NES Specify handing. Privacy uses a Privacy Bolt.

NES-ERS: available only in 32D.

Conversions from metric to U.S. measurements are approximate.



# K 5302

design Fusital Workshop

Material Stainless Steel AISI 316 L/Materiale Acciaio Inox AISI 316 L

Matching elements/Coordinato

- Pg 88** Mortise lock functions
- Pg 98** Deadbolts/Privacy Bolts
- Pg 104** Escutcheons with deadbolts



Finish	RPS	RSS	PGE	PCY	DMY R/L Single	Retail Price
						ML-F ENTRY
32	RPS		\$ 536.00	\$ 563.00	\$ 263.00	\$ 1,450.00
		RSS	\$ 499.00	\$ 679.00	\$ 236.00	\$ 1,245.00
32D	RPS		\$ 417.00	\$ 435.00	\$ 202.00	\$ 1,200.00
		RSS	\$ 391.00	\$ 536.00	\$ 185.00	\$ 995.00

Finish	NES	ERS	PGE	PCY	DMY	DMY	Retail Price
					R/L Single	R/L Pair	ML-F ENTRY
32D	NES		\$ 700.00	\$ 760.00	\$ 350.00	\$ 680.00	\$ 1,030.00
		ERS	\$ 750.00	\$ 770.00	\$ 380.00	\$ 710.00	\$ 1,060.00

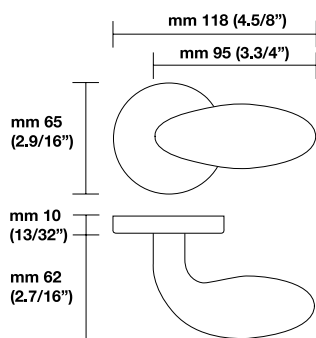

Trim options/Opzioni

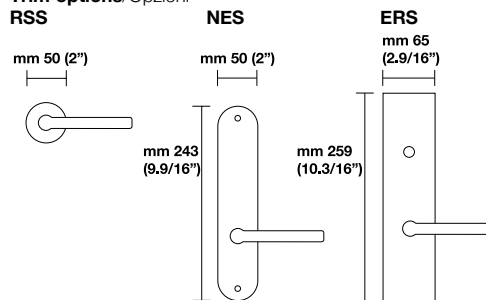

**NOTE**

RSS (2"-50mm rosette). RSS roses Privacy, supplied with 105 RSS Privacy Bolt. RPS/RQS/ERS (2.9/16"-65 mm) for standard 2.1/8" cross bore.  
**RSS = Trim not recommended for commercial use.** NES Specify handing. Privacy uses a Privacy Bolt.  
 NES-ERS: available only in 32D.  
 Conversions from metric to U.S. measurements are approximate.

Door pulls/  
Maniglioni

# P 5405 Serie Himalaya

design Taller Design Ricardo Bofill

Material Stainless Steel AISI 316 L/Materiale Acciaio Inox AISI 316 L

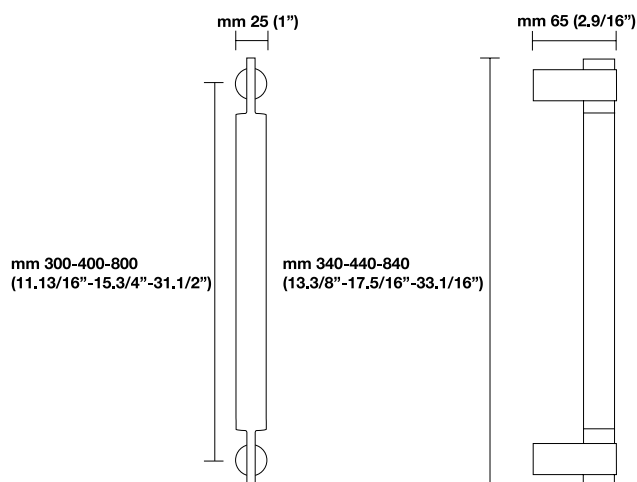

## P5405 SINGLE

Finish	Size	Dimension	Center to center $\diamond\diamond$	Retail price
32	300	mm 340x25x65 [13.3/8"x1"x2.9/16"]	mm 300 [11.13/16"]	\$ 809.00
	400	mm 440x25x65 [17.5/16"x1"x2.9/16"]	mm 400 [15.3/4"]	\$ 1,028.00
	800	mm 840x25x65 [33.1/16"x1"x2.9/16"]	mm 800 [31.1/2"]	\$ 1,253.00
32D	300	mm 340x25x65 [13.3/8"x1"x2.9/16"]	mm 300 [11.13/16"]	\$ 623.00
	400	mm 440x25x65 [17.5/16"x1"x2.9/16"]	mm 400 [15.3/4"]	\$ 785.00
	800	mm 840x25x65 [33.1/16"x1"x2.9/16"]	mm 800 [31.1/2"]	\$ 958.00

## P5405/P5405 S BACK TO BACK

Finish	Size	Dimension	Center to center $\diamond\diamond$	Retail price
32	300	mm 340x25x65 [13.3/8"x1"x2.9/16"]	mm 300 [11.13/16"]	\$ 1,709.00
	400	mm 440x25x65 [17.5/16"x1"x2.9/16"]	mm 400 [15.3/4"]	\$ 2,144.00
	800	mm 840x25x65 [33.1/16"x1"x2.9/16"]	mm 800 [31.1/2"]	\$ 2,594.00
32D	300	mm 340x25x65 [13.3/8"x1"x2.9/16"]	mm 300 [11.13/16"]	\$ 1,334.00
	400	mm 440x25x65 [17.5/16"x1"x2.9/16"]	mm 400 [15.3/4"]	\$ 1,658.00
	800	mm 840x25x65 [33.1/16"x1"x2.9/16"]	mm 800 [31.1/2"]	\$ 2,002.00

Complete with fixing systems for single mounting and pairs on wood and glass.



# P 5406 Serie K2

design Antonio Citterio

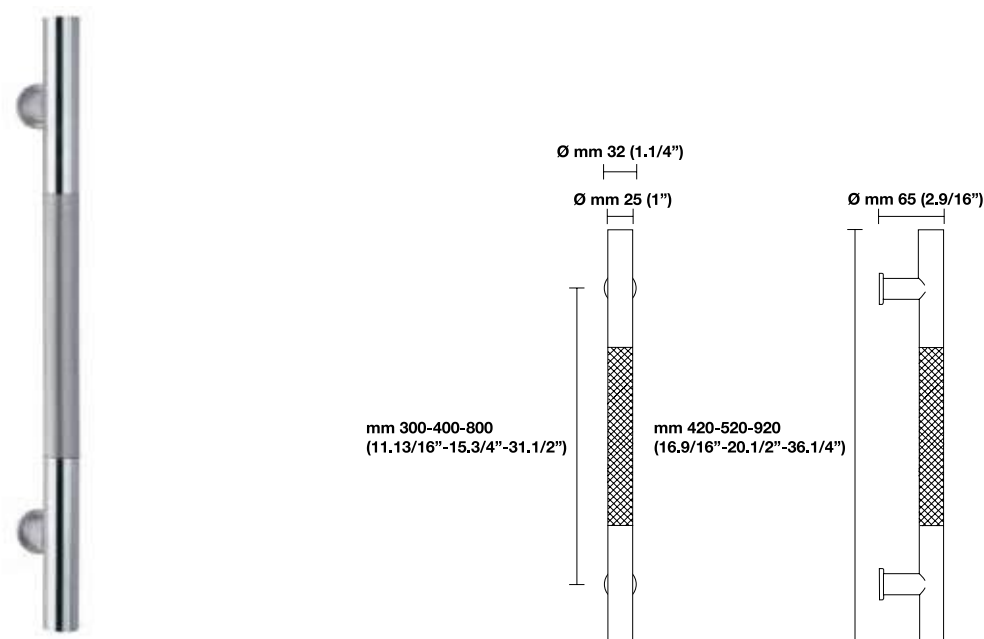

Material Stainless Steel AISI 316 L/Materiale Acciaio Inox AISI 316 L



## P5406 SINGLE

Finish	Size	Dimension	Center to center ⇄⇄	Retail price	
	32	300	mm 420x25x65 [16.9/16"x1"x2.9/16"]	mm 300 [11.13/16"]	\$ 819.00
		400	mm 520x25x65 [20.1/2"x1"x2.9/16"]	mm 400 [15.3/4"]	\$ 1,127.00
		800	mm 920x25x65 [36.1/4"x1"x2.9/16"]	mm 800 [31.1/2"]	\$ 1,376.00
	32D	300	mm 420x25x65 [16.9/16"x1"x2.9/16"]	mm 300 [11.13/16"]	\$ 657.00
		400	mm 520x25x65 [20.1/2"x1"x2.9/16"]	mm 400 [15.3/4"]	\$ 863.00
		800	mm 920x25x65 [36.1/4"x1"x2.9/16"]	mm 800 [31.1/2"]	\$ 1,051.00

## P5406/P5406 S BACK TO BACK

Finish	Size	Dimension	Center to center ⇄⇄	Retail price	
	32	300	mm 420x25x65 [16.9/16"x1"x2.9/16"]	mm 300 [11.13/16"]	\$ 1,726.00
		400	mm 520x25x65 [20.1/2"x1"x2.9/16"]	mm 400 [15.3/4"]	\$ 2,344.00
		800	mm 920x25x65 [36.1/4"x1"x2.9/16"]	mm 800 [31.1/2"]	\$ 2,839.00
	32D	300	mm 420x25x65 [16.9/16"x1"x2.9/16"]	mm 300 [11.13/16"]	\$ 1,401.00
		400	mm 520x25x65 [20.1/2"x1"x2.9/16"]	mm 400 [15.3/4"]	\$ 1,811.00
		800	mm 920x25x65 [36.1/4"x1"x2.9/16"]	mm 800 [31.1/2"]	\$ 2,188.00

Complete with fixing systems for single mounting and pairs on wood and glass.

# P 5408 Serie K2

design Antonio Citterio

Material Stainless Steel AISI 316 L/Materiale Acciaio Inox AISI 316 L

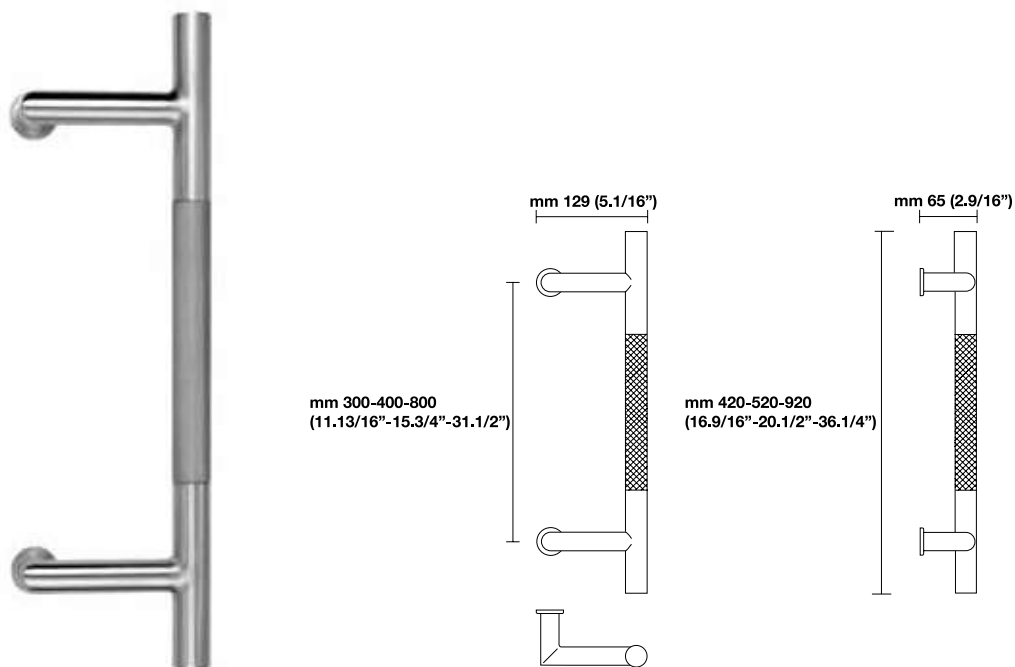

## P5408 SINGLE

Finish	Size	Dimension	Center to center	Retail price
32	300	mm 420x129x65 [16.9/16"x5.1/16"x2.9/16"]	mm 300 [11.13/16"]	\$ 1,463.00
	400	mm 520x129x65 [20.1/2"x5.1/16"x2.9/16"]	mm 400 [15.3/4"]	\$ 1,727.00
	800	mm 920x129x65 [36.1/4"x5.1/16"x2.9/16"]	mm 800 [31.1/2"]	\$ 1,997.00
32D	300	mm 420x129x65 [16.9/16"x5.1/16"x2.9/16"]	mm 300 [11.13/16"]	\$ 1,128.00
	400	mm 520x129x65 [20.1/2"x5.1/16"x2.9/16"]	mm 400 [15.3/4"]	\$ 1,324.00
	800	mm 920x129x65 [36.1/4"x5.1/16"x2.9/16"]	mm 800 [31.1/2"]	\$ 1,531.00

## P5408/P5408 S BACK TO BACK

Finish	Size	Dimension	Center to center	Retail price
32	300	mm 420x129x65 [16.9/16"x5.1/16"x2.9/16"]	mm 300 [11.13/16"]	\$ 3,016.00
	400	mm 520x129x65 [20.1/2"x5.1/16"x2.9/16"]	mm 400 [15.3/4"]	\$ 3,543.00
	800	mm 920x129x65 [36.1/4"x5.1/16"x2.9/16"]	mm 800 [31.1/2"]	\$ 4,081.00
32D	300	mm 420x129x65 [16.9/16"x5.1/16"x2.9/16"]	mm 300 [11.13/16"]	\$ 2,347.00
	400	mm 520x129x65 [20.1/2"x5.1/16"x2.9/16"]	mm 400 [15.3/4"]	\$ 2,819.00
	800	mm 920x129x65 [36.1/4"x5.1/16"x2.9/16"]	mm 800 [31.1/2"]	\$ 3,149.00

Complete with fixing systems for single mounting and pairs on wood and glass.



Mortise locks

# Rosette options

## KEYED CYLINDER

RP Plain Rosette with cylinder collar  
mm 65 (2.9/16")



(shown w/H 38 Door lever)

RPS Plain Rosette Stainless steel with cylinder collar  
mm 65 (2.9/16")



(shown w/H 5004 Door lever)

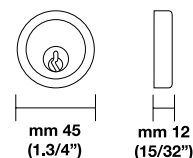

## THUMBTURN INTERIOR/EMERGENCY RELEASE PRIVACY

RP Plain Rosette mm 65 (2.9/16")  
Thumbturn (Interior)



(shown w/H 326 Door lever)

Emergency Release (Privacy)

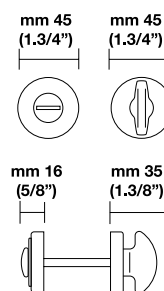

RQ Square Rosette mm 65 (2.9/16")  
Thumbturn (Interior)



(shown w/H 311 Door lever)

Emergency Release (Privacy)

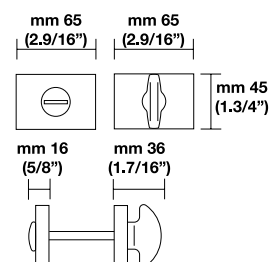

RT Traditional Rosette mm 65 (2.9/16")  
Thumbturn (Interior)



(shown w/H 1004 Door lever)

Emergency Release (Privacy)

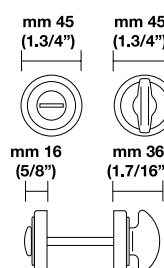

## NOTE

Valli&Valli mortise locks are available with either Round, Square Rosettes or Escutcheon Plates as shown here. Conversions from metric to U.S. measurements are approximate.



# Rosette options

## THUMBTURN INTERIOR/EMERGENCY RELEASE PRIVACY

RPS Plain Rosette Stainless steel mm 65 (2.9/16")

Thumbturn (Interior)

Emergency Release (Privacy)



(shown w/H 5004 Door lever)

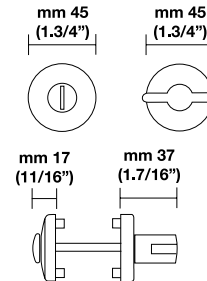

RQS Rectangular Rosette Stainless steel mm 65 (2.9/16")

Thumbturn (Interior)

Emergency Release (Privacy)



(shown w/H 5008 Door lever)

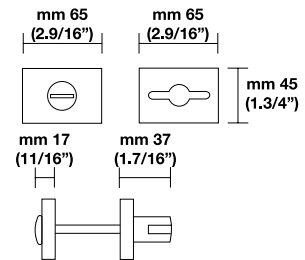

# Escutcheon plate options

## KEYED CYLINDER

ER/ERS Rectangular Escutcheon

ET Traditional Escutcheon



(shown w/H 311 Door lever)



(shown w/H 179 Door lever)

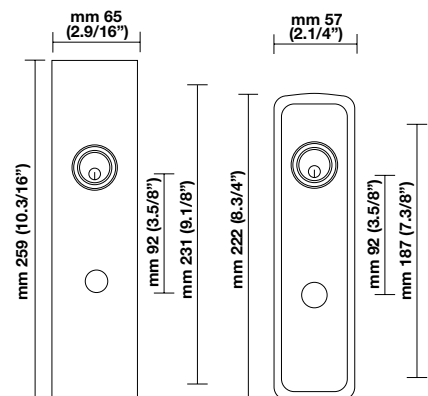

Escutcheon plate: Need to specify handing  
Conversions from metric to U.S. measurements are approximate.

# Escutcheon plate options

## KEYED CYLINDER

EP Plain Escutcheon



(shown w/H 38 Door lever)

NES Narrow Plain Escutcheon Stainless steel



(shown w/H 5004 Door lever)

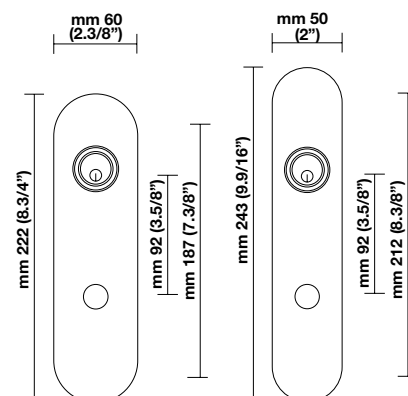

## THUMBTURN INTERIOR/EMERGENCY RELEASE PRIVACY

Thumbturn (Interior)

ER/ERS Rectangular Escutcheon



(shown w/H 311 Door lever)

Stainless steel

NES Narrow Plain Escutcheon



(shown w/H 5004 Door lever)

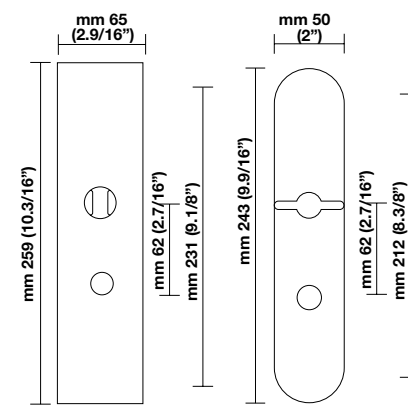

Emergency Release (Privacy)

ER/ERS Rectangular Escutcheon



(shown w/H 311 Door lever)

EP Plain Escutcheon



(shown w/H 38 Door lever)

ET Traditional Escutcheon



(shown w/H 179 Door lever)

Escutcheon plate: Need to specify handing  
Conversions from metric to U.S. measurements are approximate.

# Fusital Group I - Mortise locks

Material: solid brass

## DOOR LEVERS

H 310<sup>1</sup>, H 315, H 317, H 326, H 327, H 330, H 334, H 338<sup>1</sup>, H 341, H 348, H 355<sup>1</sup>, H 361, H 362, H 363, H 364, H 367, H 368, H 370, H372

						Retail Price
	RP	RQ	RS	EP/ET	ER	RQ/K 1225
<b>ML F/Entrance</b>	\$ 870.00	\$ 980.00	\$ 780.00	\$ 820.00	\$ 850.00	\$ 1,000.00
<b>ML FD/Entrance</b>	\$ 910.00	\$ 1,020.00	\$ 820.00	\$ 860.00	\$ 890.00	
<b>ML FW/Entrance</b>	\$ 850.00	\$ 960.00	\$ 740.00	\$ 790.00	\$ 830.00	
<b>ML B/Entrance</b>	\$ 850.00	\$ 960.00	\$ 750.00	\$ 790.00	\$ 830.00	
<b>ML E/Office</b>	\$ 820.00	\$ 890.00	\$ 730.00	\$ 820.00	\$ 830.00	
<b>ML EW/Storeroom</b>	\$ 790.00	\$ 850.00	\$ 690.00	\$ 790.00	\$ 830.00	
<b>ML J/Classroom</b>	\$ 820.00	\$ 890.00	\$ 730.00	\$ 830.00	\$ 860.00	
<b>ML N/Passage</b>	\$ 690.00	\$ 720.00	\$ 590.00	\$ 710.00	\$ 740.00	
<b>ML LF/Privacy</b>	\$ 870.00	\$ 990.00	\$ 780.00	\$ 780.00	\$ 820.00	\$ 1,000.00
<b>ML AC/Entrance</b>	\$ 850.00	\$ 940.00	\$ 760.00	\$ 830.00	\$ 860.00	
<b>ML H/Hotel</b>	-	-	-	\$ 770.00	\$ 850.00	
<b>ML NC/Communicating</b>	\$ 480.00	\$ 490.00	\$ 490.00	\$ 550.00	\$ 570.00	
<b>ML ELEC/Electrified</b>	\$ 1,840.00	\$ 1,920.00	\$ 1,750.00	\$ 1,840.00	\$ 1,880.00	

Series Group I	Finish options (see note per RQ-EP-ER)		Series Group I	Finish options (see note per RQ-EP-ER)	
<b>H 310<sup>1</sup></b>	26	26D	<b>H 355<sup>1</sup></b>	26	26D
<b>H 315</b>	03/22	26/22	<b>H 361</b>	14	15 26 26D
<b>H 317</b>	26	26D	<b>H 362</b>	26	26D
<b>H 326</b>	03	26D	<b>H 363</b>	26	26D
<b>H 327</b>	03	26D	<b>H 364</b>	26	26D
<b>H 330</b>	26D		<b>H 367</b>	26	26D
<b>H 334</b>	03	26D	<b>H 368</b>	26	26D
<b>H 338<sup>1</sup></b>	03 <sup>1</sup>	03D <sup>1</sup> 14 15 26D	<b>H 370</b>	26	26D
<b>H 341</b>	26/32D		<b>H 372</b>	26	26D
<b>H 348</b>	03/03D	26 26D			

<sup>1</sup>Not currently in production. Available for minimum quantity per order/Details page 14

### NOTE

All levers are stocked in finishes indicated.

EP = 03-26 Standard Finish ER = 15-26-26D Standard Finish RQ = 14-15-26-26D Standard Finish

Standard Bolt Finish = 03D/Satin Brass, 26D/Satin Chrome.

**RS/RSQ = Trim not recommended for commercial use.**

Without cylinder deduct \$15.00 retail price.

Narrow mortise lock backset, see page 138. Call factory for pricing.

# Fusital Group II - Mortise locks

Material: solid brass

**DOOR LEVERS** H 37, H 311, H 329, H 332<sup>1</sup>, H 335<sup>1</sup>, H 343, H 359, H 369<sup>1</sup>, H 371, H 375<sup>2</sup>, H 376

						Retail Price
	RP	RQ	RS	EP/ET	ER	RQ/K 1225
<b>ML F/Entrance</b>	\$ 960.00	\$ 1,100.00	\$ 890.00	\$ 920.00	\$ 950.00	\$ 1,200.00
<b>ML FD/Entrance</b>	\$ 1,020.00	\$ 1,130.00	\$ 930.00	\$ 970.00	\$ 1,000.00	
<b>ML FW/Entrance</b>	\$ 950.00	\$ 1,070.00	\$ 850.00	\$ 900.00	\$ 940.00	
<b>ML B/Entrance</b>	\$ 960.00	\$ 1,070.00	\$ 860.00	\$ 890.00	\$ 930.00	
<b>ML E/Office</b>	\$ 930.00	\$ 990.00	\$ 840.00	\$ 930.00	\$ 970.00	
<b>ML EW/Storeroom</b>	\$ 900.00	\$ 960.00	\$ 800.00	\$ 890.00	\$ 930.00	
<b>ML J/Classroom</b>	\$ 930.00	\$ 990.00	\$ 840.00	\$ 930.00	\$ 970.00	
<b>ML N/Passage</b>	\$ 800.00	\$ 820.00	\$ 700.00	\$ 820.00	\$ 850.00	
<b>ML LF/Privacy</b>	\$ 970.00	\$ 1,100.00	\$ 880.00	\$ 880.00	\$ 920.00	\$ 1,200.00
<b>ML AC/Entrance</b>	\$ 950.00	\$ 1,040.00	\$ 880.00	\$ 940.00	\$ 970.00	
<b>ML H/Hotel</b>	-	-	-	\$ 870.00	\$ 940.00	
<b>ML NC/Communicating</b>	\$ 530.00	\$ 540.00	\$ 540.00	\$ 600.00	\$ 610.00	
<b>ML ELEC/Electrified</b>	\$ 1,950.00	\$ 2,040.00	\$ 1,850.00	\$ 1,940.00	\$ 1,980.00	

**Series Group II** **Finish options (see note per RQ-EP-ER)**

<b>H 37</b>	03/03D			
<b>H 311</b>	14	15	26	26D
<b>H 329</b>	03/03D		26/26D	
<b>H 332<sup>1</sup></b>	03	06B		
<b>H 335<sup>1</sup></b>	26			
<b>H 343</b>	14	15	26	26D
<b>H 359</b>	14	15	26	26D
<b>H 369<sup>1</sup></b>	26	26D		
<b>H 371</b>	26	26D		
<b>H 375<sup>2</sup></b>	06M	06M/03	22/03	
<b>H 376</b>	26	26/26D	26D	

<sup>1</sup> Not currently in production. Available for minimum quantity per order/Details page 14

<sup>2</sup> H 375: EP/ER/ET Available on special request only

**NOTE**

All levers are stocked in finishes indicated.

EP = 03-26 Standard Finish ER = 15-26-26D Standard Finish RQ = 14-15-26-26D Standard Finish  
 Standard Bolt Finish = 03D/Satin Brass, 26D/Satin Chrome.

**RS/RSQ = Trim not recommended for commercial use.**

Without cylinder deduct \$15.00 retail price.

Narrow mortise lock backset, see page 138. Call factory for pricing.

# Fusital Group III - Mortise locks

Material: solid brass

## DOOR LEVERS

H 350

						Retail Price
	RP	RQ	RS	EP/ET	ER	RQ/K 1225
<b>ML F/Entrance</b>	\$ 1,280.00	\$ 1,390.00	\$ 1,190.00	\$ 1,230.00	\$ 1,260.00	\$ 1,420.00
<b>ML FD/Entrance</b>	\$ 1,320.00	\$ 1,430.00	\$ 1,230.00	\$ 1,270.00	\$ 1,300.00	
<b>ML FW/Entrance</b>	\$ 1,250.00	\$ 1,390.00	\$ 1,150.00	\$ 1,200.00	\$ 1,240.00	
<b>ML B/Entrance</b>	\$ 1,250.00	\$ 1,380.00	\$ 1,160.00	\$ 1,190.00	\$ 1,240.00	
<b>ML E/Office</b>	\$ 1,240.00	\$ 1,300.00	\$ 1,140.00	\$ 1,230.00	\$ 1,270.00	
<b>ML EW/Storeroom</b>	\$ 1,200.00	\$ 1,260.00	\$ 1,100.00	\$ 1,200.00	\$ 1,240.00	
<b>ML J/Classroom</b>	\$ 1,240.00	\$ 1,300.00	\$ 1,140.00	\$ 1,230.00	\$ 1,270.00	
<b>ML N/Passage</b>	\$ 1,100.00	\$ 1,130.00	\$ 1,000.00	\$ 1,120.00	\$ 1,160.00	
<b>ML LF/Privacy</b>	\$ 1,280.00	\$ 1,400.00	\$ 1,190.00	\$ 1,190.00	\$ 1,230.00	\$ 1,420.00
<b>ML AC/Entrance</b>	\$ 1,260.00	\$ 1,340.00	\$ 1,160.00	\$ 1,240.00	\$ 1,270.00	
<b>ML H/Hotel</b>	-	-	-	\$ 1,180.00	\$ 1,250.00	
<b>ML NC/Communicating</b>	\$ 680.00	\$ 690.00	\$ 690.00	\$ 750.00	\$ 760.00	
<b>ML ELEC/Electrified</b>	\$ 2,250.00	\$ 2,310.00	\$ 2,160.00	\$ 2,250.00	\$ 2,300.00	

## Series Group III

Finish options (see note per RQ-EP-ER)

H 350	14	15	26	26D
-------	----	----	----	-----

## Deadlock

Specify backset

finish options 03M - 06M - 15 - 16 - 22M - 26 - 26D - GREY - 32 - 32D

Retail Price

	Rosette										
	Finish	03M	06M	15	16	22M	26	26D	GREY	32	32D
<b>ML - Deadlock</b>	RP	\$ 300.00	\$ 340.00	\$ 340.00	\$ 310.00	\$ 310.00	\$ 320.00	\$ 335.00	\$ 320.00		
<b>ML - Deadlock</b>	RPS									\$ 485.00	\$ 443.00
<b>ML - Deadlock</b>	RQ	\$ 400.00	\$ 440.00	\$ 425.00	\$ 400.00	\$ 400.00	\$ 400.00	\$ 425.00	\$ 400.00	-	-

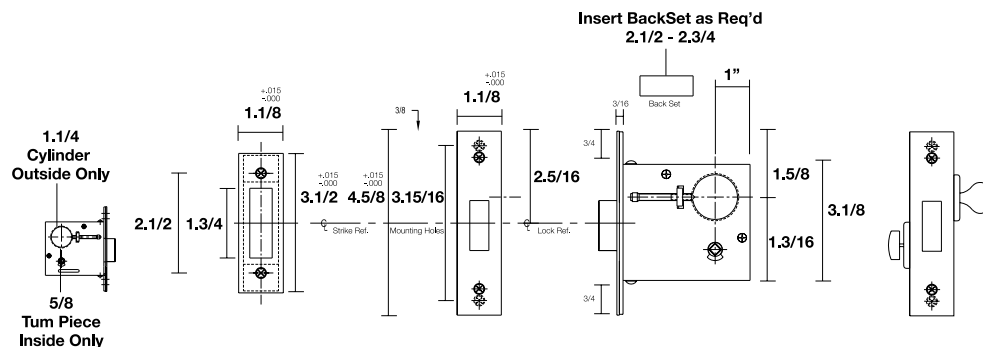

# Fusital Group IV - Mortise locks

Material: solid brass

	DOOR LEVERS					Retail Price
	RP	RQ	RS	EP/ET	ER	RQ/K 1225
	H 344 <sup>1</sup> , H 352 <sup>1</sup> , H 354, H 356, H 373					
<b>ML F/Entrance</b>	\$ 1,320.00	\$ 1,440.00	\$ 1,250.00	\$ 1,280.00	\$ 1,310.00	\$ 1,450.00
<b>ML FD/Entrance</b>	\$ 1,380.00	\$ 1,480.00	\$ 1,280.00	\$ 1,320.00	\$ 1,350.00	
<b>ML FW/Entrance</b>	\$ 1,300.00	\$ 1,420.00	\$ 1,200.00	\$ 1,260.00	\$ 1,290.00	
<b>ML B/Entrance</b>	\$ 1,300.00	\$ 1,420.00	\$ 1,220.00	\$ 1,260.00	\$ 1,290.00	
<b>ML E/Office</b>	\$ 1,280.00	\$ 1,350.00	\$ 1,050.00	\$ 1,280.00	\$ 1,300.00	
<b>ML EW/Storeroom</b>	\$ 1,260.00	\$ 1,320.00	\$ 1,080.00	\$ 1,250.00	\$ 1,290.00	
<b>ML J/Classroom</b>	\$ 1,280.00	\$ 1,350.00	\$ 1,050.00	\$ 1,280.00	\$ 1,320.00	
<b>ML N/Passage</b>	\$ 1,150.00	\$ 1,280.00	\$ 1,050.00	\$ 1,170.00	\$ 1,200.00	
<b>ML LF/Privacy</b>	\$ 1,340.00	\$ 1,440.00	\$ 1,240.00	\$ 1,240.00	\$ 1,270.00	\$ 1,450.00
<b>ML AC/Entrance</b>	\$ 1,320.00	\$ 1,420.00	\$ 1,240.00	\$ 1,310.00	\$ 1,350.00	
<b>ML H/Hotel</b>	-	-	-	\$ 1,220.00	\$ 1,300.00	
<b>ML NC/Communicating</b>	\$ 710.00	\$ 800.00	\$ 720.00	\$ 780.00	\$ 790.00	
<b>ML ELEC/Electrified</b>	\$ 2,310.00	\$ 2,400.00	\$ 2,200.00	\$ 2,300.00	\$ 2,350.00	
<b>Series Group IV</b>	<b>Finish options (see note per RQ-EP-ER)</b>					
<b>H 344<sup>1</sup></b>	26	26D				
<b>H 352</b>	26	26D				
<b>H 354</b>	03	26	26D			
<b>H 356</b>	26	26D				
<b>H 373</b>	26/16					

<sup>1</sup>Not currently in production. Available for minimum quantity per order/Details page 14

**NOTE**

\*H 344 (only available in RP rosette):

All levers are stocked in finishes indicated.

EP = 03-26 Standard Finish ER = 15-26-26D Standard Finish RQ = 14-15-26-26D Standard Finish

Standard Bolt Finish = 03D/Satin Brass, 26D/Satin Chrome.

**RS/RSQ = Trim not recommended for commercial use.**

Without cylinder deduct \$15.00 retail price.

**Narrow backset mortise lock available/Detail page 138**

1.1/2"-1.3/4"-2"-2.1/4" Backset

**Solid Brass**

**How to order**

**Call factory for pricing**

ML F Narrow RP 15

ML FW Narrow RP 15

ML EW Narrow RP 15

ML E Narrow RP 15

ML J Narrow RP 15

ML N Narrow RP 15

ML LF Narrow RP 15

(Other finishes available on request). RQ, RQS not available.

**Stainless Steel**

**How to order**

**Call factory for pricing**

ML F Narrow RPS 32D

ML FW Narrow RPS 32D

ML EW Narrow RPS 32D

ML E Narrow RPS 32D

ML J Narrow RPS 32D

ML N Narrow RPS 32D

ML LF Narrow RPS 32D

# Fusital Inox Group I/Group II - Mortise locks

Material: stainless steel AISI 316 L

GROUP I	H 5008 <sup>1</sup> , K 5301, K 5302				Retail Price
	RPS	RQS	RSS	NES	ERS
ML F/Entrance	\$ 1,200.00	\$ 1,220.00	\$ 995.00	\$ 1,030.00	\$ 1,060.00
ML FD/Entrance	\$ 1,250.00	\$ 1,280.00	\$ 1,040.00	\$ 1,070.00	\$ 1,100.00
ML FW/Entrance	\$ 1,180.00	\$ 1,200.00	\$ 970.00	\$ 1,010.00	\$ 1,040.00
ML B/Entrance	\$ 1,180.00	\$ 1,200.00	\$ 970.00	\$ 1,020.00	\$ 1,050.00
ML E/Office	\$ 1,080.00	\$ 1,150.00	\$ 870.00	\$ 990.00	\$ 1,070.00
ML EW/Storeroom	\$ 1,040.00	\$ 1,100.00	\$ 830.00	\$ 960.00	\$ 1,040.00
ML J/Classroom	\$ 1,080.00	\$ 1,200.00	\$ 870.00	\$ 990.00	\$ 1,070.00
ML N/Passage	\$ 900.00	\$ 950.00	\$ 680.00	\$ 850.00	\$ 930.00
ML LF/Privacy	\$ 1,200.00	\$ 1,300.00	\$ 990.00	\$ 950.00	\$ 1,000.00
ML AC/Entrance	\$ 1,150.00	\$ 1,200.00	\$ 940.00	\$ 1,040.00	\$ 1,100.00
ML H/Hotel	-	-	-	\$ 1,040.00	\$ 1,080.00
ML NC/Communicating	\$ 600.00	\$ 650.00	\$ 580.00	\$ 610.00	\$ 660.00
ML ELEC/Electrified	\$ 2,100.00	\$ 2,220.00	\$ 1,880.00	\$ 2,010.00	\$ 2,100.00

GROUP II	H 5015/32D, H 5017				Retail Price
	RPS	RQS	RSS	NES	ERS
ML F/Entrance	\$ 1,460.00	\$ 1,480.00	\$ 1,250.00	\$ 1,280.00	\$ 1,320.00
ML FD/Entrance	\$ 1,500.00	\$ 1,520.00	\$ 1,290.00	\$ 1,320.00	\$ 1,360.00
ML FW/Entrance	\$ 1,420.00	\$ 1,450.00	\$ 1,220.00	\$ 1,260.00	\$ 1,290.00
ML B/Entrance	\$ 1,420.00	\$ 1,470.00	\$ 1,240.00	\$ 1,270.00	\$ 1,300.00
ML E/Office	\$ 1,320.00	\$ 1,330.00	\$ 1,120.00	\$ 1,240.00	\$ 1,320.00
ML EW/Storeroom	\$ 1,300.00	\$ 1,400.00	\$ 1,080.00	\$ 1,210.00	\$ 1,280.00
ML J/Classroom	\$ 1,320.00	\$ 1,350.00	\$ 1,120.00	\$ 1,240.00	\$ 1,320.00
ML N/Passage	\$ 1,150.00	\$ 1,200.00	\$ 930.00	\$ 1,100.00	\$ 1,190.00
ML LF/Privacy	\$ 1,450.00	\$ 1,480.00	\$ 1,240.00	\$ 1,200.00	\$ 1,250.00
ML AC/Entrance	\$ 1,400.00	\$ 1,490.00	\$ 1,200.00	\$ 1,310.00	\$ 1,350.00
ML H/Hotel	-	-	-	\$ 1,300.00	\$ 1,330.00
ML NC/Communicating	\$ 730.00	\$ 800.00	\$ 710.00	\$ 730.00	\$ 790.00
ML ELEC/Electrified	\$ 2,340.00	\$ 2,450.00	\$ 2,130.00	\$ 2,260.00	\$ 2,330.00

<sup>1</sup>Not currently in production. Available for minimum quantity per order/Details page 14

#### NOTE

RPS, RQS, RSS, NES, ERS: 32D standard finish available.

**32/Polish add \$ 250.00 retail price to 32D/Satin finish. Minimum quantity applied.**

Without cylinder deduct \$ 15.00 retail price.

**RSS/RSQS: trim not recommended for commercial use.**

Narrow mortise lock backset see page 138. Call factory for pricing.

# Fusital Inox Group III/Group IV - Mortise locks

Material: stainless steel AISI 316 L

GROUP III	H 5015 black leather, H 5015 orange leather, H 5021				Retail Price
	RPS	RQS	RSS	NES	ERS
<b>ML F/Entrance</b>	\$ 1,820.00	\$ 1,950.00	\$ 1,590.00	\$ 1,630.00	\$ 1,660.00
<b>ML FD/Entrance</b>	\$ 1,860.00	\$ 1,950.00	\$ 1,630.00	\$ 1,670.00	\$ 1,700.00
<b>ML FW/Entrance</b>	\$ 1,790.00	\$ 1,800.00	\$ 1,570.00	\$ 1,620.00	\$ 1,650.00
<b>ML B/Entrance</b>	\$ 1,780.00	\$ 1,800.00	\$ 1,580.00	\$ 1,620.00	\$ 1,650.00
<b>ML E/Office</b>	\$ 1,680.00	\$ 1,750.00	\$ 1,460.00	\$ 1,590.00	\$ 1,670.00
<b>ML EW/Storeroom</b>	\$ 1,650.00	\$ 1,700.00	\$ 1,430.00	\$ 1,560.00	\$ 1,630.00
<b>ML J/Classroom</b>	\$ 1,680.00	\$ 1,750.00	\$ 1,460.00	\$ 1,590.00	\$ 1,670.00
<b>ML N/Passage</b>	\$ 1,500.00	\$ 1,550.00	\$ 1,280.00	\$ 1,450.00	\$ 1,530.00
<b>ML LF/Privacy</b>	\$ 1,800.00	\$ 1,900.00	\$ 1,580.00	\$ 1,550.00	\$ 1,600.00
<b>ML AC/Entrance</b>	\$ 1,750.00	\$ 1,800.00	\$ 1,530.00	\$ 1,650.00	\$ 1,720.00
<b>ML H/Hotel</b>	-	-	-	\$ 1,660.00	\$ 1,690.00
<b>ML NC/Communicating</b>	\$ 900.00	\$ 950.00	\$ 880.00	\$ 900.00	\$ 960.00
<b>ML ELEC/Electrified</b>	\$ 2,700.00	\$ 2,800.00	\$ 2,480.00	\$ 2,600.00	\$ 2,680.00
<b>GROUP IV</b>	H 5014				Retail Price
	RPS	RQS	RSS	NES	ERS
<b>ML F/Entrance</b>	\$ 1,040.00	\$ 1,060.00	\$ 830.00	\$ 870.00	\$ 890.00
<b>ML FD/Entrance</b>	\$ 1,070.00	\$ 1,100.00	\$ 870.00	\$ 910.00	\$ 940.00
<b>ML FW/Entrance</b>	\$ 1,000.00	\$ 1,040.00	\$ 800.00	\$ 850.00	\$ 870.00
<b>ML B/Entrance</b>	\$ 1,000.00	\$ 1,040.00	\$ 800.00	\$ 840.00	\$ 850.00
<b>ML E/Office</b>	\$ 900.00	\$ 910.00	\$ 700.00	\$ 830.00	\$ 900.00
<b>ML EW/Storeroom</b>	\$ 870.00	\$ 880.00	\$ 660.00	\$ 790.00	\$ 860.00
<b>ML J/Classroom</b>	\$ 900.00	\$ 910.00	\$ 700.00	\$ 830.00	\$ 900.00
<b>ML N/Passage</b>	\$ 720.00	\$ 750.00	\$ 510.00	\$ 680.00	\$ 760.00
<b>ML LF/Privacy</b>	\$ 1,030.00	\$ 1,060.00	\$ 820.00	\$ 790.00	\$ 830.00
<b>ML AC/Entrance</b>	\$ 990.00	\$ 1,050.00	\$ 760.00	\$ 880.00	\$ 930.00
<b>ML H/Hotel</b>	-	-	-	\$ 880.00	\$ 910.00
<b>ML NC/Communicating</b>	\$ 520.00	\$ 540.00	\$ 500.00	\$ 520.00	\$ 580.00
<b>ML ELEC/Electrified</b>	\$ 1,920.00	\$ 2,050.00	\$ 1,720.00	\$ 1,840.00	\$ 1,920.00

#### NOTE

RPS, RQS, RSS, NES, ERS: 32D standard finish available.

**32/Polish add \$ 250.00 retail price to 32D/Satin finish. Minimum quantity applied.**

Without cylinder deduct \$ 15.00 retail price.

**RSS/RSQS: trim not recommended for commercial use.**

Narrow mortise lock backset see page 138. Call factory for pricing.



Deadbolts/  
Privacy bolts

# Deadbolts

**101 RP Plain**  
 Solid brass

**101 RQ Square**  
 Solid brass

**101 RT Traditional**  
 Solid brass

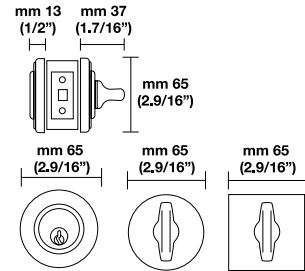
**101 SINGLE CYLINDER**

**101 RPS Plain**  
 Stainless steel AISI 316 L

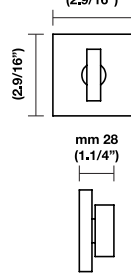
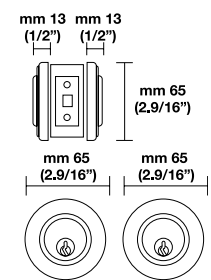
**101 RQS Square**  
 Stainless steel AISI 316 L

**101 RQ / K1225**  
 Solid brass  
 mm 65 (2.9/16")

**102 DOUBLE CYLINDER**

# Privacy bolts

**105 RSP Plain**  
 Solid brass

**105 RSQ Square**  
 Solid brass

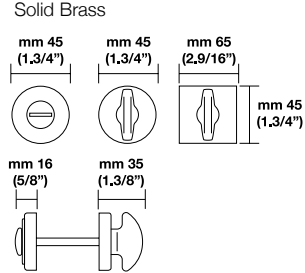
**105 RST Traditional**  
 Solid brass

**105 PRIVACY BOLT**  
 Solid Brass

**105 RSS Plain**  
 Stainless steel AISI 316 L

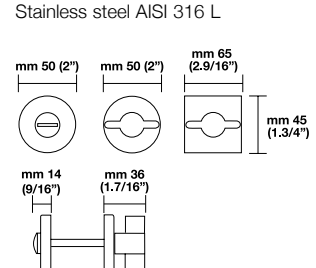
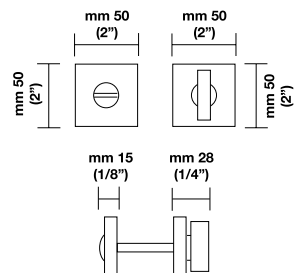
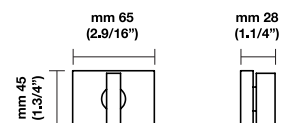
**105 RSQS Square**  
 Stainless steel AISI 316 L

**105 PRIVACY BOLT**  
 Stainless steel AISI 316 L

**105 RSQ/K 1225 RSQ (2" x 2")**  
 Solid brass

**105 RSQ / K1225 (2.9/16" x 1.3/4")**  
 Solid brass

**Call factory for pricing**

# Deadbolts

Material: solid brass, stainless steel 316 L

## 101 SINGLE CYLINDER DEADBOLT

Retail Price

Finish	RT	RP	RQ	RPS	RQS
03	-	\$ 274.00	-	-	-
03D	-	\$ 278.00	-	-	-
03/03D	\$ 248.00	-	-	-	-
03M	-	\$ 275.00	\$ 365.00	-	-
06A	\$ 271.00	\$ 282.00	-	-	-
06B	\$ 259.00	\$ 267.00	\$ 363.00	-	-
06M	-	\$ 291.00	\$ 385.00	-	-
14	\$ 272.00	\$ 273.00	\$ 369.00	-	-
15	\$ 269.00	\$ 272.00	\$ 375.00	-	-
16	-	\$ 259.00	\$ 335.00	-	-
22M	-	\$ 268.00	\$ 345.00	-	-
26	-	\$ 261.00	\$ 349.00	-	-
26D	-	\$ 262.00	\$ 365.00	-	-
26/26D	\$ 258.00	-	-	-	-
GREY	-	\$ 266.00	\$ 345.00	-	-
32	-	-	-	\$ 511.00	\$ 530.00
32D	-	-	-	\$ 427.00	\$ 435.00

## 101 SINGLE CYLINDER DEADBOLT/LESS EXTERIOR TRIM

Retail Price

Finish	RT/LE	RP/LE	RQ/LE	RPS/LE	RQS/LE
03	-	\$ 203.00	-	-	-
03D	-	\$ 203.00	-	-	-
03/03D	\$ 181.00	-	-	-	-
03M	-	\$ 195.00	\$ 229.00	-	-
06A	\$ 204.00	\$ 208.00	-	-	-
06B	\$ 185.00	\$ 185.00	-	-	-
06M	-	\$ 200.00	\$ 235.00	-	-
14	\$ 199.00	\$ 197.00	\$ 238.00	-	-
15	\$ 188.00	\$ 187.00	\$ 229.00	-	-
16	-	\$ 193.00	\$ 226.00	-	-
22M	-	\$ 195.00	\$ 226.00	-	-
26	-	\$ 190.00	\$ 225.00	-	-
26D	-	\$ 187.00	\$ 229.00	-	-
26/26D	\$ 190.00	-	-	-	-
GREY	-	\$ 195.00	\$ 226.00	-	-
32	-	-	-	\$ 335.00	\$ 318.00
32D	-	-	-	\$ 279.00	\$ 255.00

**101 RQ/K 1225**

Finish	RQ	Retail Price			
03M	\$ 375.00	-	-	-	-
06M	\$ 390.00	-	-	-	-
14	\$ 372.00	-	-	-	-
15	\$ 385.00	-	-	-	-
16	\$ 345.00	-	-	-	-
22M	\$ 350.00	-	-	-	-
26	\$ 351.00	-	-	-	-
26D	\$ 380.00	-	-	-	-
GREY	\$ 350.00	-	-	-	-









**102 DOUBLE CYLINDER DEADBOLT**

Finish	RT	RP	RQ	RPS	Retail Price	
					RQS	
03	-	\$ 264.00	-	-	-	-
03D	-	\$ 271.00	-	-	-	-
03/03D	\$ 260.00	-	-	-	-	-
06A	\$ 259.00	\$ 277.00	-	-	-	-
06B	\$ 277.00	\$ 292.00	-	-	-	-
14	\$ 279.00	\$ 287.00	\$ 351.00	-	-	-
15	\$ 287.00	\$ 293.00	\$ 372.00	-	-	-
26	-	\$ 277.00	\$ 334.00	-	-	-
26D	-	\$ 274.00	\$ 353.00	-	-	-
26/26D	\$ 270.00	-	-	-	-	-
32	-	-	-	\$ 494.00	\$ 533.00	-
32D	-	-	-	\$ 427.00	\$ 458.00	-









# Privacy bolts

Material: solid brass, stainless steel 316 L

## 105 RSQ/K 1225 PRIVACY BOLT 2" X 2"

	Finish	RSQ				Retail Price
	03M	\$ 345.00	-	-	-	-
	06M	\$ 362.00	-	-	-	-
	14	\$ 375.00	-	-	-	-
	15	\$ 345.00	-	-	-	-
	16	\$ 320.00	-	-	-	-
	22M	\$ 320.00	-	-	-	-
	26	\$ 315.00	-	-	-	-
	26D	\$ 345.00	-	-	-	-
	GREY	\$ 320.00	-	-	-	-

## 105 RSQ/K 1225 LESS EXTERIOR TRIM 2" X 2"

	Finish	RSQ/LE				Retail Price
	03M	\$ 197.00	-	-	-	-
	06M	\$ 206.00	-	-	-	-
	14	\$ 210.00	-	-	-	-
	15	\$ 200.00	-	-	-	-
	16	\$ 185.00	-	-	-	-
	22M	\$ 185.00	-	-	-	-
	26	\$ 185.00	-	-	-	-
	26D	\$ 200.00	-	-	-	-
	GREY	\$ 185.00	-	-	-	-

**105 PRIVACY BOLTS**

Retail Price

Finish	RST	RSP	RSQ	RSS	RSQS
03	-	\$ 215.00	-	-	-
03D	-	\$ 215.00	-	-	-
03/03D	\$ 236.00	-	-	-	-
03M	-	\$ 245.00	\$ 335.00	-	-
06A	\$ 289.00	\$ 240.00	-	-	-
06B	-	\$ 262.00	-	-	-
06M	-	\$ 262.00	\$ 352.00	-	-
14	\$ 270.00	\$ 259.00	\$ 374.00	-	-
15	\$ 257.00	\$ 245.00	\$ 341.00	-	-
16	-	\$ 221.00	\$ 312.00	-	-
22M	-	\$ 222.00	\$ 312.00	-	-
26	-	\$ 218.00	\$ 314.00	-	-
26D	-	\$ 245.00	\$ 341.00	-	-
26/26D	\$ 286.00	-	-	-	-
GREY	-	\$ 222.00	\$ 312.00	-	-
32	-	-	-	\$ 247.00	\$ 450.00
32D	-	-	-	\$ 226.00	\$ 361.00

**105 PRIVACY BOLTS/LESS EXTERIOR TRIM**

Retail Price

Finish	RST/LE	RSP/LE	RSQ/LE	RSS/LE	RSQS/LE
03	-	\$ 135.00	-	-	-
03D	-	\$ 135.00	-	-	-
03/03D	\$ 148.00	-	-	-	-
03M	-	-	\$ 198.00	-	-
06A	\$ 174.00	\$ 160.00	\$ 208.00	-	-
06M	-	-	\$ 208.00	-	-
14	\$ 161.00	\$ 158.00	\$ 212.00	-	-
15	\$ 156.00	\$ 152.00	\$ 199.00	-	-
16	-	\$ 140.00	\$ 186.00	-	-
22M	-	-	\$ 186.00	-	-
26	-	\$ 138.00	\$ 184.00	-	-
26D	-	\$ 152.00	\$ 199.00	-	-
26/26D	\$ 170.00	-	-	-	-
GREY	-	-	\$ 186.00	-	-
32	-	-	-	\$ 198.00	\$ 286.00
32D	-	-	-	\$ 166.00	\$ 237.00

Escutcheons  
with deadbolts

# Fusital/Escutcheon with deadbolts

Material: solid brass

ER - 103 Rectangular Escutcheon (shown w/H 311 Door lever)

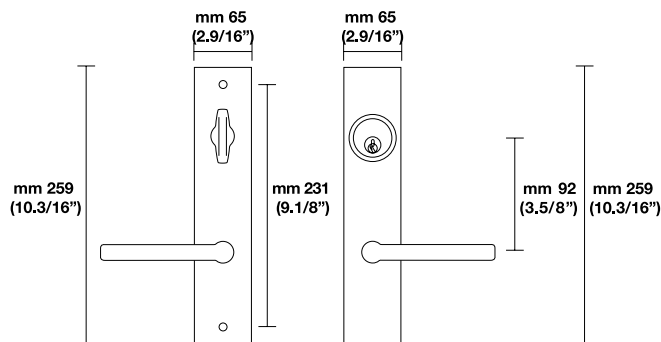
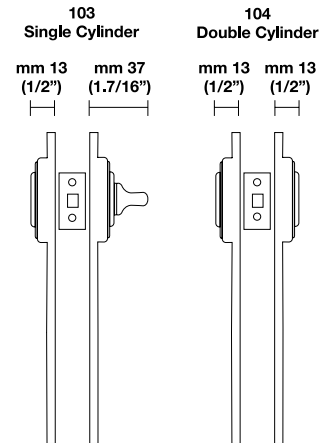

# Fusital Inox/Escutcheon with deadbolts

Material: stainless steel AISI 316 L

ERS - 103 Rectangular Escutcheon Stainless steel (shown w/H 5004 Door lever)

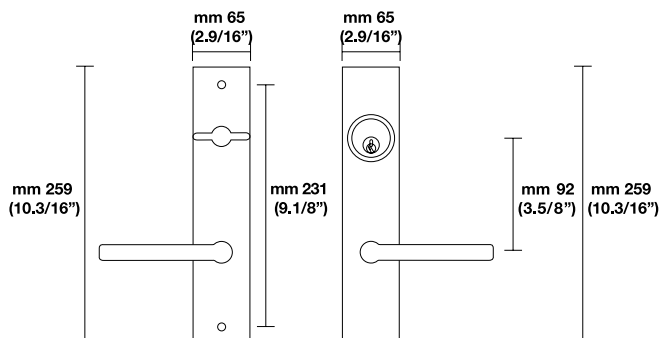
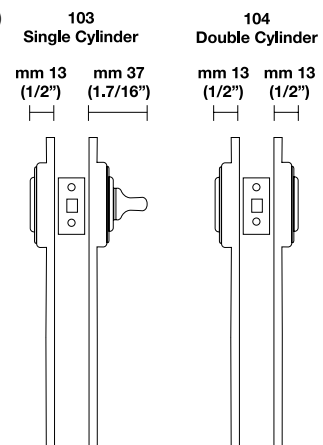

Escutcheon Plate: Need to specify handing.  
Conversions from metric to U.S. measurements are approximate.



# Fusital - Escutcheon with deadbolts

Material: solid brass

**GROUP I** H 310<sup>1</sup>, H 315, H 317, H 326, H 327, H 330, H 334, H 338<sup>1</sup>, H 341, H 348, H 355<sup>1</sup>,  
H 361, H 362, H 363, H 364, H 367, H 368, H 370, H 372

	<b>Retail Price</b>		
	<b>103</b>	<b>104</b>	<b>106</b>
<b>EP/ET</b>	\$ 700.00	\$ 680.00	\$ 630.00
<b>ER</b>	\$ 730.00	\$ 720.00	\$ 680.00

**GROUP II** H 37, H 311, H 329, H 332<sup>1</sup>, H 335<sup>1</sup>, H 343, H 359, H 369<sup>1</sup>, H 371, H 376

	<b>Retail Price</b>		
	<b>103</b>	<b>104</b>	<b>106</b>
<b>EP/ET</b>	\$ 790.00	\$ 780.00	\$ 740.00
<b>ER</b>	\$ 820.00	\$ 810.00	\$ 780.00

**GROUP III** H 350

	<b>Retail Price</b>		
	<b>103</b>	<b>104</b>	<b>106</b>
<b>EP/ET</b>	\$ 1,080.00	\$ 1,070.00	\$ 1,030.00
<b>ER</b>	\$ 1,120.00	\$ 1,100.00	\$ 1,070.00

**GROUP IV** H 352<sup>1</sup>, H 354, H 356, H 373

	<b>Retail Price</b>		
	<b>103</b>	<b>104</b>	<b>106</b>
<b>EP/ET</b>	\$ 1,150.00	\$ 1,140.00	\$ 1,100.00
<b>ER</b>	\$ 1,200.00	\$ 1,190.00	\$ 1,160.00

<sup>1</sup>Not currently in production. Available for minimum quantity per order/Details page 14

**NOTE**

- 103** Escutcheon Single Cylinder
- 104** Escutcheon Double Cylinder
- 106** Escutcheon Privacy Bolt
- EP/ET 03-26 Standard finish
- ER 15-26-26D Standard finish

# Fusital Inox - Escutcheon with deadbolts

Material: stainless steel AISI 316 L

**GROUP I** H 5008<sup>1</sup>, K 5301, K 5302

	<b>Retail Price</b>		
	<b>103</b>	<b>104</b>	<b>106</b>
<b>ERS</b>	\$ 920.00	\$ 940.00	\$ 820.00

**GROUP II** H 5015/32D, H 5017

	<b>Retail Price</b>		
	<b>103</b>	<b>104</b>	<b>106</b>
<b>ERS</b>	\$ 1,200.00	\$ 1,250.00	\$ 1,100.00

**GROUP III** H 5015 black leather, H 5015 orange leather, H 5021

	<b>Retail Price</b>		
	<b>103</b>	<b>104</b>	<b>106</b>
<b>ERS</b>	\$ 1,530.00	\$ 1,550.00	\$ 1,400.00

**GROUP IV** H 5014

	<b>Retail Price</b>		
	<b>103</b>	<b>104</b>	<b>106</b>
<b>ERS</b>	\$ 730.00	\$ 760.00	\$ 630.00

<sup>1</sup>Not currently in production. Available for minimum quantity per order/Details page 14

**NOTE**

**103** Escutcheon Single Cylinder

**104** Escutcheon Double Cylinder

**106** Escutcheon Privacy Bolt

ERS available only in 32D finish



# Multi-Point Trims

# Functions

Multi-Point Trim

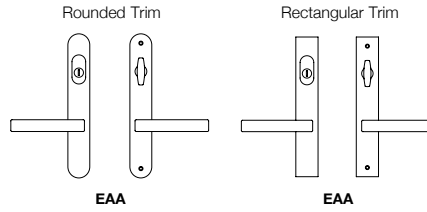

### EAA Entry Set-Key above

Entry function with American cylinder above the lever, 92mm center to center.

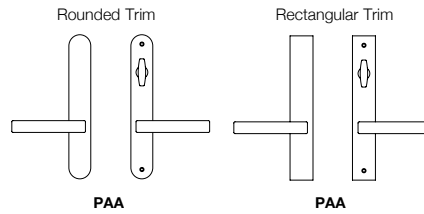

### PAA Patio Set-No keyway

Patio function with the interior thumbturn above the lever, no keyway on the exterior plate.

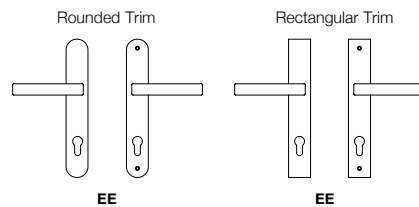

### EE Entry Set-With profile cylinder

Entry function with profile cylinder 92mm center to center.



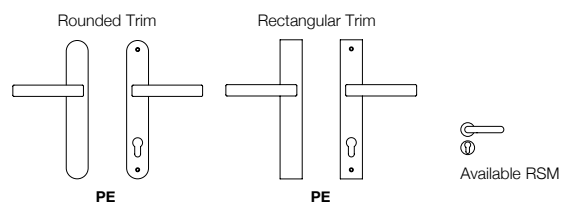

**PE Patio Set-Profile cylinder no key**  
Patio function with 1/2 profile cylinder and thumbturn, no keyway on the exterior plate.

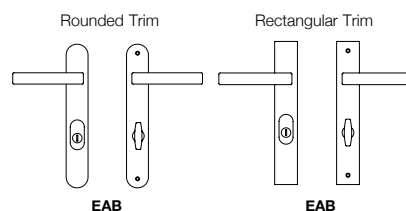

**EAB Entry Set-Key below**  
Entry function with American cylinder below the lever, 92mm center to center.

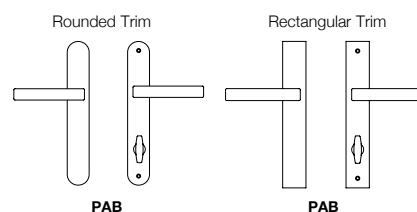

**PAB Patio Set-No keyway**  
Patio function with the interior thumbturn below the lever, no keyway on the exterior plate.

**CE Entry Set-Custom**  
Custom entry function with special center to center sizes. Uses a profile cylinder.

**DA Active Dummy**  
Active dummy pair.

# Functions

Multi-Point Trim Options

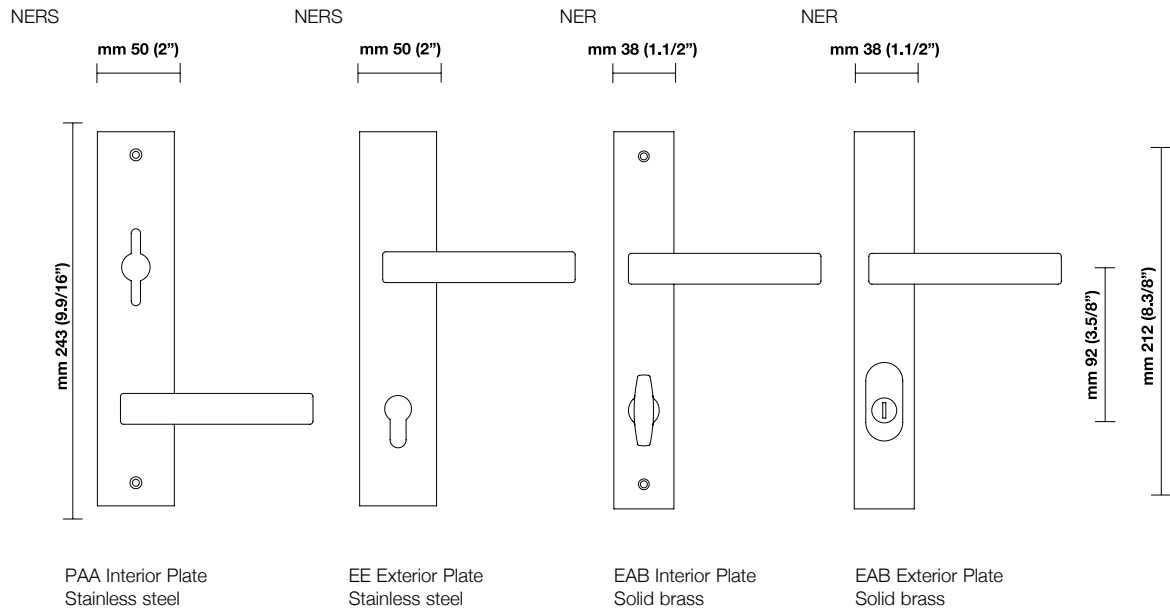
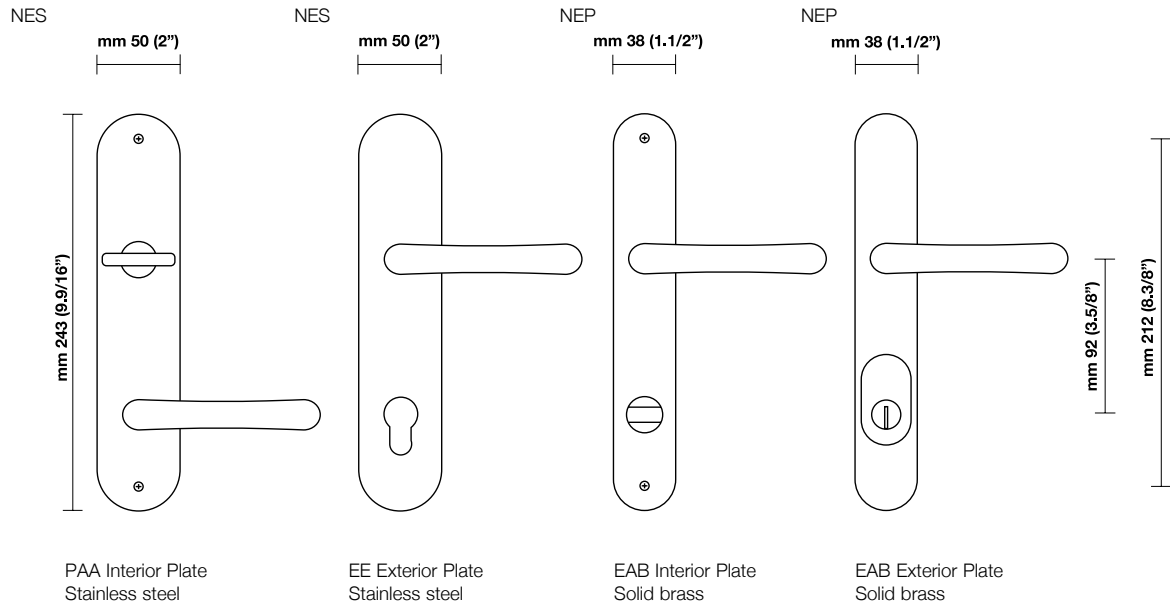

# How to order

Multi-Point and Narrow Long Escutcheon plates

## MULTI-POINT & NARROW LONG ESCUTCHEON PLATES

To order these products, informations should be specified in the same sequence as the example given:

1.Lever/Knob	2.Trim options	3.Function	4.Finish	5.Handing	6.Miscellaneous
HXXX	NEP (Brass) NES (Inox)	EE	15	RH	KA4

**1. Lever** - choose from Fusital product lines.

**2. Trim Options** - narrow long escutcheon plates or round rosettes - choose from the following:

- NEP plain style, narrow long escutcheon plate in solid brass.
- NES plain style, narrow long escutcheon plate in stainless steel.
- RSM plain style, small 1.3/4" (45mm) rosette in solid brass. Includes profile cylinder with matching rosettes.
- RSSM plain style, small 2" (50mm) rosette in stainless steel. Includes profile cylinder with matching rosettes.
- NER narrow long rectangular escutcheon plate in solid brass.
- NERS narrow long rectangular escutcheon plate in stainless steel.

**3. Function** - choose from the following:

- EAB entry function with American cylinder below the lever or knob. (92mm center to center.)
- EAA entry function with American cylinder above the lever or knob. (92mm center to center.)
- PAB patio function with thumbturn only, below the lever or knob.
- PAA patio function with thumbturn only, above the lever or knob.
- EE entry function with European profile cylinder. (92mm center to center.)
- PE patio function with European 1/2 profile cylinder (thumbturn).
- CE entry or patio function with custom center to center sizes. Supplied with profile cylinder.
- PGE passage function with tubular latch. For interior doors.
- PCY privacy function with tubular latch and privacy bolt. For interior doors.
- DA pair dummy, active with through spindle.
- DS single dummy, surface mounted spindle.

**4. Finishes** - choose from stock or custom ordered finishes. See price list for options.

- Special finishes available. Add \$ 100.00 NET cost to the polished brass price.
- Fusital Inox is only available in 32D satin stainless steel. No plating of stainless steel hardware.

**5. Handing**

- All sets require handing. See handing diagram on page 123.

**6. Miscellaneous**

- Special door thickness, keying info., split finishes.
- Maximum 2.1/4" thick door.
- Additional charges apply to these special details. Call factory for pricing.

**7. Generic Codes**

- |             |                 |
|-------------|-----------------|
| K 1789 NEP  | Solid Brass     |
| K 1805 NER  | Solid Brass     |
| K 5701 NES  | Stainless Steel |
| K 5713 NERS | Stainless Steel |



# Fusital - Multi-Point

Material: solid brass

## GROUP I

H 310<sup>1</sup>, H 315, H 317, H 326, H 327, H 330, H 334, H 338<sup>1</sup>, H 341, H 348, H 355<sup>1</sup>, H 361, H 362, H 363, H 364, H 367, H 368, H 370, H 372

**Standard finish 03 (Brass)/** H 315, H 326, H 327, H 330, H 334, H 338, H 348

		Retail Price		
		NEP 03 - 15	NER 26 - 26D	RSM 03 - 15
<b>EAB</b>	<b>Entry Set - key below</b>	\$ 590.00	\$ 690.00	-
<b>PAB</b>	<b>Patio Set - no keyway</b>	\$ 500.00	\$ 600.00	-
<b>EAA</b>	<b>Entry Set - key above</b>	\$ 590.00	\$ 690.00	-
<b>PAA</b>	<b>Patio Set - no keyway</b>	\$ 500.00	\$ 600.00	-
<b>EE</b>	<b>Entry Set - with profile cyl.</b>	\$ 840.00	\$ 930.00	\$ 820.00
<b>PE</b>	<b>Patio Set - profile cyl. no key</b>	\$ 560.00	\$ 650.00	\$ 480.00
<b>CE</b>	<b>Entry Set - custom</b>	Call Factory		
<b>DA</b>	<b>Active Dummy</b>	\$ 260.00	\$ 560.00	\$ 340.00

## GROUP II

H 37, H 311, H 329, H 332<sup>1</sup>, H 335<sup>1</sup>, H 343, H 359, H 369<sup>1</sup>, H 371, 376

**Standard finish 03 (Brass)/** H 329

**Standard finish 15 (Satin nickel)**

		Retail Price		
		NEP 03 - 15	NER 26 - 26D	RSM 03 - 15
<b>EAB</b>	<b>Entry Set - key below</b>	\$ 700.00	\$ 800.00	-
<b>PAB</b>	<b>Patio Set - no keyway</b>	\$ 600.00	\$ 710.00	-
<b>EAA</b>	<b>Entry Set - key above</b>	\$ 700.00	\$ 800.00	-
<b>PAA</b>	<b>Patio Set - no keyway</b>	\$ 600.00	\$ 710.00	-
<b>EE</b>	<b>Entry Set - with profile cyl.</b>	\$ 950.00	\$ 1,040.00	\$ 930.00
<b>PE</b>	<b>Patio Set - profile cyl. no key</b>	\$ 670.00	\$ 760.00	\$ 580.00
<b>CE</b>	<b>Entry Set - custom</b>	Call Factory		
<b>DA</b>	<b>Active Dummy</b>	\$ 370.00	\$ 660.00	\$ 450.00

<sup>1</sup>Not currently in production. Available for minimum quantity per order/Details page 14

### NOTE

NEP: 03-15 Standard finish. Add \$ 100.00 net for non standard finish.

NER: 26-26D Standard finish. Add \$ 100.00 net for non standard finish.

NEP: Narrow long escutcheon plate (solid brass)

NER: Narrow long escutcheon rectangular plate (solid brass)

RSM: Small 1.3/4" round rosette (brass). RSM include profile cylinder with matching rosettes.

# Fusital - Multi-Point

Material: solid brass

## GROUP III

H 350

### Standard finish 15

		Retail Price		
		NEP 03 - 15	NER 26 - 26D	RSM 03 - 15
<b>EAB</b>	<b>Entry Set - key below</b>	\$ 1,000.00	\$ 1,100.00	-
<b>PAB</b>	<b>Patio Set - no keyway</b>	\$ 910.00	\$ 1,010.00	-
<b>EAA</b>	<b>Entry Set - key above</b>	\$ 1,000.00	\$ 1,100.00	-
<b>PAA</b>	<b>Patio Set - no keyway</b>	\$ 910.00	\$ 1,010.00	-
<b>EE</b>	<b>Entry Set - with profile cyl.</b>	\$ 1,250.00	\$ 1,350.00	\$ 1,230.00
<b>PE</b>	<b>Patio Set - profile cyl. no key</b>	\$ 970.00	\$ 1,060.00	\$ 890.00
<b>CE</b>	<b>Entry Set - custom</b>	Call Factory		
<b>DA</b>	<b>Active Dummy</b>	\$ 670.00	\$ 970.00	\$ 750.00

## GROUP IV

H 352<sup>1</sup>, H 354, H 356, H 373

### Standard finish 03 (Brass)/ H 354

		Retail Price		
		NEP 03 - 15	NER 26 - 26D	RSM 03 - 15
<b>EAB</b>	<b>Entry Set - key below</b>	\$ 1,050.00	\$ 1,150.00	-
<b>PAB</b>	<b>Patio Set - no keyway</b>	\$ 960.00	\$ 1,060.00	-
<b>EAA</b>	<b>Entry Set - key above</b>	\$ 1,050.00	\$ 1,150.00	-
<b>PAA</b>	<b>Patio Set - no keyway</b>	\$ 960.00	\$ 1,060.00	-
<b>EE</b>	<b>Entry Set - with profile cyl.</b>	\$ 1,300.00	\$ 1,390.00	\$ 1,280.00
<b>PE</b>	<b>Patio Set - profile cyl. no key</b>	\$ 1,020.00	\$ 1,120.00	\$ 930.00
<b>CE</b>	<b>Entry Set - custom</b>	Call Factory		
<b>DA</b>	<b>Active Dummy</b>	\$ 720.00	\$ 1,020.00	\$ 800.00

<sup>1</sup>Not currently in production. Available for minimum quantity per order/Details page 14

#### NOTE

NEP: 03-15 Standard finish. Add \$ 100.00 net for non standard finish.

NER: 26-26D Standard finish. Add \$ 100.00 net for non standard finish.

NEP: Narrow long escutcheon plate (solid brass)

NER: Narrow long escutcheon rectangular plate (solid brass)

RSM: Small 1.3/4" round rosette (brass). RSM include profile cylinder with matching rosettes.

# Fusital Inox - Multi-Point

Material: stainless steel AISI 316 L

## GROUP I

H 5008<sup>1</sup>

		Retail Price		
		NES - 32D	NERS - 32D	RSSM - 32D
<b>EAB</b>	<b>Entry Set - key below</b>	\$ 850.00	\$ 920.00	-
<b>PAB</b>	<b>Patio Set - no keyway</b>	\$ 730.00	\$ 780.00	-
<b>EAA</b>	<b>Entry Set - key above</b>	\$ 850.00	\$ 910.00	-
<b>PAA</b>	<b>Patio Set - no keyway</b>	\$ 730.00	\$ 780.00	-
<b>EE</b>	<b>Entry Set - with profile cyl.</b>	\$ 1,050.00	\$ 1,100.00	\$ 870.00
<b>PE</b>	<b>Patio Set - profile cyl. no key</b>	\$ 760.00	\$ 780.00	\$ 560.00
<b>CE</b>	<b>Entry Set - custom</b>	Call Factory		
<b>DA</b>	<b>Active Dummy</b>	\$ 650.00	\$ 700.00	\$ 430.00

## GROUP II

H 5015/32D, H 5017

		Retail Price		
		NES - 32D	NERS - 32D	RSSM - 32D
<b>EAB</b>	<b>Entry Set - key below</b>	\$ 1,100.00	\$ 1,180.00	-
<b>PAB</b>	<b>Patio Set - no keyway</b>	\$ 980.00	\$ 1,040.00	-
<b>EAA</b>	<b>Entry Set - key above</b>	\$ 1,100.00	\$ 1,170.00	-
<b>PAA</b>	<b>Patio Set - no keyway</b>	\$ 980.00	\$ 1,040.00	-
<b>EE</b>	<b>Entry Set - with profile cyl.</b>	\$ 1,300.00	\$ 1,350.00	\$ 1,120.00
<b>PE</b>	<b>Patio Set - profile cyl. no key</b>	\$ 1,020.00	\$ 1,030.00	\$ 820.00
<b>CE</b>	<b>Entry Set - custom</b>	Call Factory		
<b>DA</b>	<b>Active Dummy</b>	\$ 900.00	\$ 970.00	\$ 680.00

<sup>1</sup>Not currently in production. Available for minimum quantity per order/Details page 14

### NOTE

NERS/NES/RSSM available only in 32D finish

NERS/NES Narrow long escutcheon plate (Stainless steel)

RSSM Small 2" round rosette (Stainless steel). RSSM include profile cylinder with matching rosettes

# Fusital Inox - Multi-Point

Material: stainless steel AISI 316 L

## GROUP III

H 5015 black leather, H 5015 orange leather, H 5021

		Retail Price		
		NES - 32D	NERS - 32D	RSSM - 32D
<b>EAB</b>	<b>Entry Set - key below</b>	\$ 1,440.00	\$ 1,520.00	-
<b>PAB</b>	<b>Patio Set - no keyway</b>	\$ 1,330.00	\$ 1,380.00	-
<b>EAA</b>	<b>Entry Set - key above</b>	\$ 1,440.00	\$ 1,530.00	-
<b>PAA</b>	<b>Patio Set - no keyway</b>	\$ 1,320.00	\$ 1,380.00	-
<b>EE</b>	<b>Entry Set - with profile cyl.</b>	\$ 1,650.00	\$ 1,690.00	\$ 1,460.00
<b>PE</b>	<b>Patio Set - profile cyl. no key</b>	\$ 1,370.00	\$ 1,380.00	\$ 1,150.00
<b>CE</b>	<b>Entry Set - custom</b>	Call Factory		
<b>DA</b>	<b>Active Dummy</b>	\$ 1,250.00	\$ 1,300.00	\$ 1,020.00

## GROUP IV

H 5014

		Retail Price		
		NES - 32D	NERS - 32D	RSSM - 32D
<b>EAB</b>	<b>Entry Set - key below</b>	\$ 680.00	\$ 750.00	-
<b>PAB</b>	<b>Patio Set - no keyway</b>	\$ 560.00	\$ 610.00	-
<b>EAA</b>	<b>Entry Set - key above</b>	\$ 680.00	\$ 740.00	-
<b>PAA</b>	<b>Patio Set - no keyway</b>	\$ 560.00	\$ 610.00	-
<b>EE</b>	<b>Entry Set - with profile cyl.</b>	\$ 880.00	\$ 930.00	\$ 700.00
<b>PE</b>	<b>Patio Set - profile cyl. no key</b>	\$ 590.00	\$ 600.00	\$ 390.00
<b>CE</b>	<b>Entry Set - Custom</b>	Call factory		
<b>DA</b>	<b>Active Dummy</b>	\$ 480.00	\$ 520.00	\$ 260.00

### NOTE

NERS/NES/RSSM available only in 32D finish

NERS/NES Narrow long escutcheon plate (Stainless steel)

RSSM Small 2" round rosette (Stainless steel). RSSM include profile cylinder with matching rosettes

Miscellaneous  
parts

# Miscellaneous replacement parts

## TUBULAR LATCH BOLTS 28 DEGREE

Part No.	Overall size latch
01E 2.3/8" backset, passage 28°	3.1/4"
02E 2.3/4" backset, passage 28°	3.5/8"
03E 2.3/8" backset, privacy 28°	3.1/4"
04E 2.3/4" backset, privacy 28°	3.5/8"
01UL 2.3/8" backset, passage	3.11/32"
02UL 2.3/4" backset, passage	3.3/4"

Includes: face plate, strike plate and screws. Retracts 28°.  
Dust Box: Included

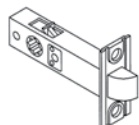

## HOUSINGS

X 2122	Housing, no spring
X 2124M	Housing, spring loaded for long escutcheon plates
X 1115	Interior underosette to mount interior deadbolt trim
X 1116	Underosettes for mounting mortise lock round rosettes
X 0550	Underosettes for mounting deadbolt square roses
X 0547	Underosettes for mounting mortise lock square roses

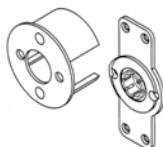

## MORTISE CYLINDERS - C Keyway

Part No.	Door Thickness
C 01 15/16 cyl. 1.3/8" D	
C 02 1-1/8 cyl. 1.3/4" D	
C 03 1-1/4 cyl. 2" D - 1.3/4" M	
C 04 1-3/8 cyl. 2.1/4" D - 2" M	
C 05 1-1/2 cyl. 2.1/2" D - 2.1/4" M	
C 06 cust. length 3" D - 2.1/2" - 3" M	

Must specify Deadbolt (D) or Mortise Lock (M). Straight cam is used for mortise locks without thumbturns.



## DEADBOLT LATCH & PRIVACY BOLTS

Part No.	Overall size latch
09 deadbolt 2.3/8" backset	3.1/4"
10 deadbolt 2.3/4" backset	3.5/8"
Above Includes: deadbolt latch, mortise cylinder housing, strike plate for both metal and wood jambs, face plate and screws (no cylinder).	
X 30 2.3/8" privacy bolt	3.5/16"
X 31 2.3/4" privacy bolt	3.3/4"

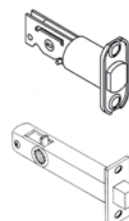

## STRIKE PLATES

Part No.	Description
TS 01	T-strikes (tubular latch)
ETS-115	extended for doors 2.1/4" thick
ETS-175	extended for doors 2.1/2" & up
FL 01	Full lip (tubular latch)
EL-115	extended for doors 2.1/4" thick
EL-175	extended for doors 2.1/2" & up
ML 01	Mortise lock strike (standard)
ML 02	extended for 2.1/4" doors
ML 03	extended for 2.3/8" & up

(a) T-strike (b) Full Lip (c) Mortise strike

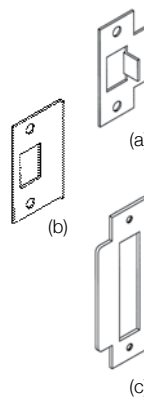

## ALLEN WRENCHES & SET SCREW (metric)

X 0285	set screws with allen wrench for brass levers and knobs
X 0286	stainless steel set screws with allen wrench
W 04	for deadbolt cylinder locking screw
Set screws with allen wrenches for brass levers and knobs Set screws size ø-mm 6 wide x 9 long	



## DUST BOX

Part No.	Description
DB-01	Dust Box T Strike
DB-03	Dust Box Full Lip Strike
DB-02	Dust Box Mortise Lock

# Miscellaneous replacement parts

## ROSETTES

### RT Traditional 2.9/16" (65mm)



K 1749 RS (ML) threaded each  
K 1741 RRS PGE CP  
K 1741 RRS PCY CPK  
K 1741 RRS SF (DMY) each

### RS Plain 1.3/4" (45mm)



K 1112 RS

### RSQ Plain 1.3/4" (45mm)



K 386 RS

### RQ Square 2.9/16" (65mm)

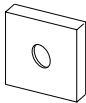

K 1780 RS I (inside) ML each  
K 1780 RS E (outside) ML each  
K 1798 RRS PGE  
K 1798 RRS PCY  
K 1798 RRS (DMY) each

### RP Plain 2.9/16" (65mm)



K 1748 RS (ML) threaded each  
K 1742 RRS PGE CP  
K 1742 RRS PCY CPK  
K 1742 RRS SF (DMY) each

### RPS Stainless steel 2.9/16" (65mm)



R 5701 (ML) threaded each  
R 5703 RRS PGE  
R 5703 RRS PCY CPK  
R 5703 RRS SF (DMY) each

### RSS Stainless steel 2" (50mm)



R 5704 RRS PGE  
R 5702 RS (DMY) each

### RQS Stainless steel Square 2.9/16" (65mm)

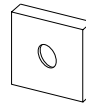

R 5709 RS I (inside) ML each  
R 5709 RS E (outside) ML each  
R 5707 RRS PGE  
R 5707 RRS PCY  
R 5707 RRS DMY each

## SPINDLES

Part No.	Description	Overall length
----------	-------------	----------------

X 016	8mm, solid spindle for doors 1.3/8" to 2.1/4"	4.1/2"
X 0102	8mm, solid spindle for doors 2.3/8" to 3"	5.5/8"
X 0163/X 1119-114	8mm, two piece spindle for doors 1.3/8" to 2.1/4"	4.1/2"
X 0163/X 1119-145	8mm, two piece spindle for doors 2.3/8" to 3"	5.3/4"
X 0571	8mm, surface mounted dummy	
X 0571 SQ OT	8mm, surface mounted dummy (NEP, RQ)	
X 0572	8mm, opposing mounted dummy plates	
X 1118	5mm/tailpiece, for deadbolts with doors 1.3/8" to 1.3/4"	
X 1118/85mm	2 1/4 thick door for deadbolt	
X 117/5-60	5mm x 60mm, for mortise lock functions with doors 1.3/4"	
X 117/5-85	5mm x 85mm, for 105 privacy bolts with doors up to 1.3/4"	

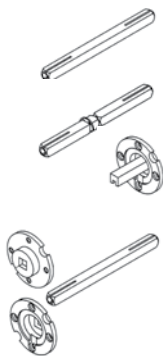

### MORTISE LOCKS

Must specify 2.1/2" or 2.3/4" backset. Must specify for levers or knobs. Includes: mortise lock body, face plate, strike plate, screws and dust box (no cylinder). Custom mortise locks and other backsets available upon special request. See page 137-138.

 UL listed 3 hours fire rating.

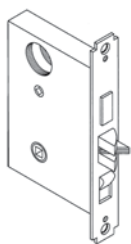

Part No.	Description
ML F TP	Entrance Handleset
ML F	Entrance (Lever Sets)
ML FD	Entrance
ML FW	Entrance
ML J	Classroom
ML AC	Entrance
ML N	Passage
ML B	Entrance
ML NC	Communicating
ML E	Office
ML LF	Privacy
ML ELEC	Electrified
ML EW	Storeroom
ML H	Hotel

See page 136-137 for lock function details.

### DEADBOLT, PRIVACY BOLT, MORTISE TRIM ONLY

#### Part No.

K 1724 RS BZG	Interior trim for 105 RST (traditional)
K 1724 RS V BZG	Exterior trim for 105 RST (traditional)
K 1725 RS BZG	Interior trim for 105 RSP (plain)
K 1725 RS V BZG	Exterior trim for 105 RSP (plain)
S 5700 RS BZG	Interior trim for 105 RSS (stainless steel)
S 5700 RS V BZG	Exterior trim for 105 RSS (stainless steel)

### PROFILE CYLINDERS - C Keyway

Part No.	Description	Door Thickness
C 07 35 mm	American Key in knob cylinder for multi-point	
C 08 72 mm	Key by thumbturn profile cylinder	1.3/4"
C 09 81 mm	Key by thumbturn profile cylinder	2.1/4"
C 12 35 mm	Half profile cylinder with thumbturn	
C 13 40 mm	Half profile cylinder with thumbturn	
C 14 35 mm	Half profile cylinder with keyway	
C 15 40 mm	Half profile cylinder with keyway	
K 1799/6	Thumbturn for profile cylinder (brass)	
S 5702 BZG MP	Thumbturn for profile cylinder (stainless steel)	

Must add price of thumbturn to profile cylinder.

### DEADBOLT & PRIVACY BOLT, MORTISE TRIM ONLY

#### Part No.

K 1781 RS BZG	Interior trim for 105 RSQ (square)
K 1781 RS VBZG	Exterior trim for 105 RSQ (square)
S 5703 RS BZG	Interior trim for 105 RSQS (square) stainless steel
S 5703 RS VBZG	Exterior trim for 105 RSQS (square) stainless steel
K 1728 RS BZG	Interior trim for traditional deadbolt (101 RT)
K 1749 RSC	Exterior trim for traditional deadbolt (101 RT)
K 1729 RS BZG	Interior trim for plain deadbolt (101 RP)
K 1748 RSC	Exterior rosette for plain deadbolt (101 RP)
R 5701 RS BZG	Interior trim for stainless steel deadbolt (101 RPS)
R 5705 RS	Exterior trim for stainless steel deadbolt (101 RPS)
R 5708 RS BZG	Interior trim for stainless steel deadbolt (101 RQS)
R 5709 RS	Exterior trim for stainless steel deadbolt (101 RQS)
K 1778 RS BZG	Interior trim for brass deadbolt (101 RQ)
K 1780 RSC	Exterior trim for brass deadbolt (101 RQ)
K 1726	Mortise lock cylinder collar (traditional)
K 1727	Mortise lock cylinder collar (plain)
R 5700	Mortise lock cylinder collar (stainless steel)
K 1767	Mortise lock cylinder collar (square)
R 5710	Mortise lock cylinder collar (square) stainless steel
X 1121 K	Cylinder collar for exterior rosette for deadbolt (brass)
X 1121K/X 0237	Cylinder collar for exterior rosette for deadbolt (stainless steel)
K 1806/1225 RS BZG	Interior trim for K 1225 RSQ (square)
K 1806/1225 RS VBZG	Exterior trim for K 1225 RSQ (square)

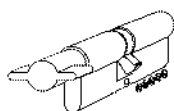
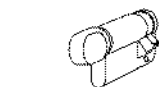
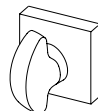
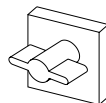



# Miscellaneous replacement parts

## PRIVACY PINS

Part No.	Description	Finish options
X 0227	for tubular latch (m3 thread)	03, 03D, 06A, 06B, 26, 26D
X 0248	for tubular latch stainless steel (m3 thread)	32
X 0248	for tubular latch stainless steel (m3 thread)	32D

## FASTENERS

Part No.	Description
X 176	Retaining ring to attach levers to rosettes and long escutcheons. Specify RH - LH
X 187	Metal washer
X 184	Retaining clip to attach thumbturns to rosettes and long escutcheons
X 1161	Locking o-ring to attach levers to rosettes and long escutcheon plates
X 0326	Nylon bushing to convert 8mm to 5mm
X 0339	Nylon bushing to convert 8mm to a flat tailpiece
X 1100	Spring for lever and rosette assembly
X 1107	Small nylon washer
X 1105	Medium nylon washer
X 1106	Large nylon washer

## SCREWS (Metric) Through screws for door levers.

Part No.	Description
X 15	standard pack for 1.3/8" or 1.3/4" doors (round rosettes)
X 17	standard pack for 1.3/8" or 1.3/4" doors (long escutcheons)
M4 x 30mm (1.1/4")	
M4 x 40mm (1.1/2")	
M4 x 50mm (2")	
M4 x 70mm X0230 (2.3/4")	
M4 x 90mm (3.1/2") non-cut & unfinished	

## Spacer Pocket Door

Part No.	Description
X 0328	1 3/8" x K1200 -K4200 - K1230

## CABINET HARDWARE METRIC SCREWS

### Part No.

---

M4 x 6mm (1/4")	
M4 x 8mm (5/16")	
M4 x 10mm (3/8")	
M4 x 12mm (1/2")	
M4 x 20mm (3/4")	
M4 x 25mm (1")	Standard size shipped unless otherwise specified
M4 x 30mm (1.1/4")	
M4 x 40mm (1.1/2")	
M4 x 45mm (1.3/4")	
M4 x 50mm (2")	
M6 x 20mm (3/4")	
M6 x 25mm (1")	
M6 x 30mm (1.1/4")	
M6 x 90mm (3.1/2") Threaded rod	
X 0216 Breadboard screw	Cabinet knob only

---

## DOOR HANDING

The hand of a door is always determined from the outside.  
 Always be sure to specify door handing for locking functions and dummy trim.

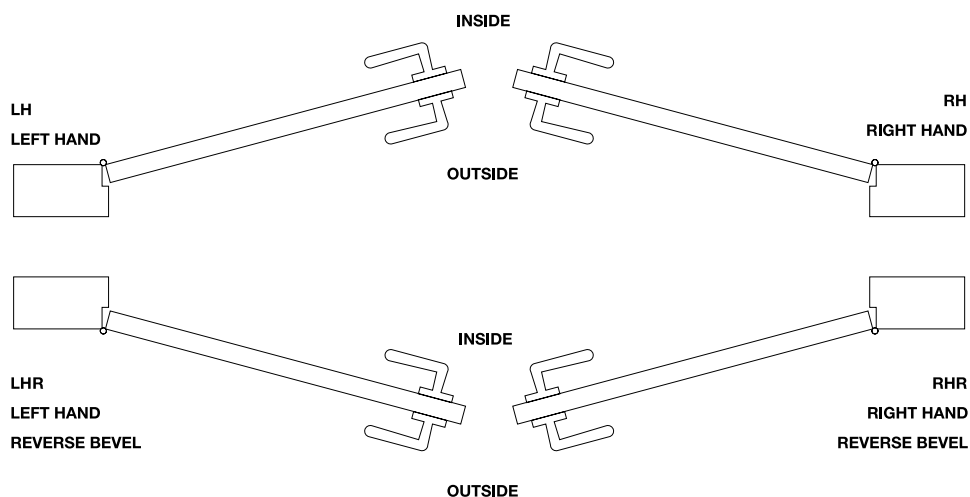

Technical  
information

# Door pull application

**X 0522**

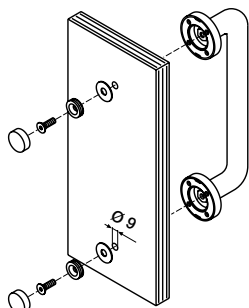

For installing a single pull handle with screw-covering rosettes on a glass door, thickness 8÷12 mm for items.  
**K 356 - K 352 - K 368**

**X 0523**

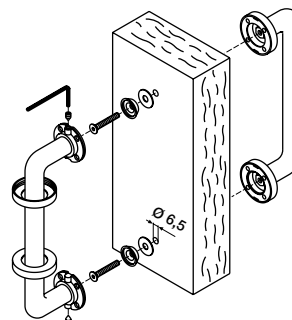

For installing a pair of pull handles with screw-covering rosettes on a wooden door, thickness 45÷55 mm 55÷65 mm for items.  
**K 356 - K 352 - K 368**

**X 0524**

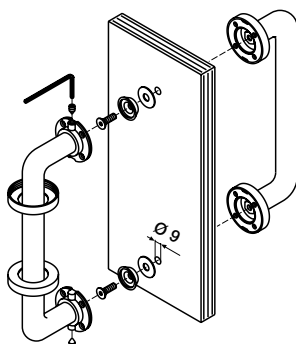

For installing a pair of pull handles with screw-covering rosettes on a glass door, thickness 8÷12 mm for items.  
**K 356 - K 352 - K 368**

**X 0525**

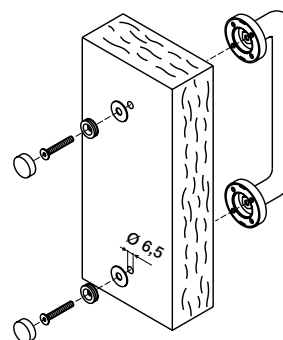

For installing a single pull handle with screw-covering rosettes on a wooden door, thickness 45÷55 mm 55÷65 mm for items.  
**K 356 - K 352 - K 368**

**X 0526**

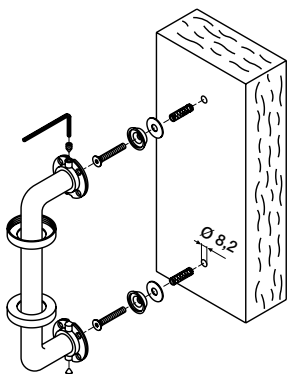

For installing a single pull handle with screw-covering rosettes on a wooden door or on a masonry wall using a brass anchor screw for items.  
**K 356 - K 352 - K 368**

**X 0527**

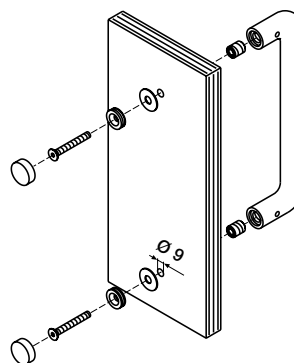

For installing a single pull handle without screw-covering rosettes on a glass door, thickness 8÷12 mm for items.  
**K 359 - K 358 - K 353**

# Door pull application

X 0528

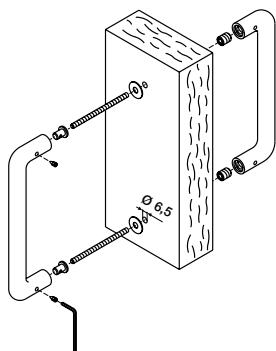

For installing a pair pull handles without screw-covering rosettes on a wooden door, thickness 45÷55 mm 55÷65 mm for items.  
**K 359 - K 358 - K 353**

X 0529

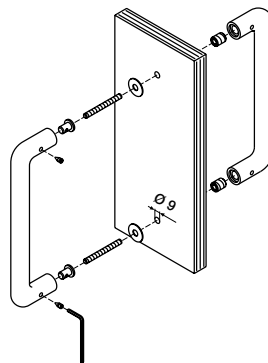

For installing a pair of pull handles without screw-covering rosettes on a glass door, thickness 8÷12 mm for items.  
**K 359 - K 358 - K 353**

X 0530

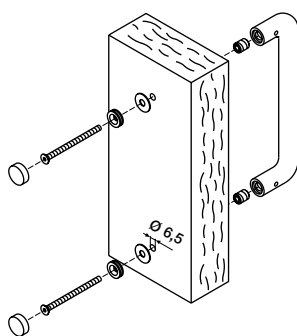

For installing a single pull handle without screw-covering rosettes on a wooden door, thickness 45÷55 mm 55÷65 mm for items.  
**K 359 - K 358 - K 353**

X 0531

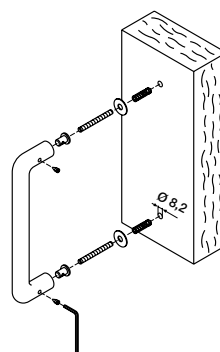

For installing a single pull handle without screw-covering rosettes on a wooden door or on a masonry wall using a brass anchor screw for items.  
**K 359 - K 358 - K 353**

X 0544

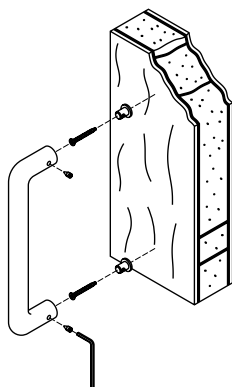

For installing a single pull handle without screw-covering rosettes on a burglary-proof steel-clad door for items.  
**K 359 - K 358 - K 353**

X 0551

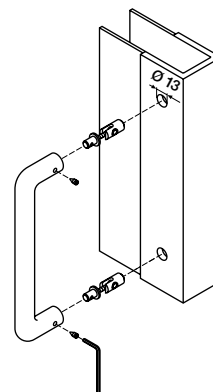

For installing a single pull handle without screw-covering rosettes on an aluminum door for items.  
**K 359 - K 358 - K 353**

# Stainless steel door pulls installation

## X 5555

For installing a single pull handle on a wooden door or on a masonry wall using a brass anchor screw

- 1 M6 grub screw
- 2 M8 special screw
- 3 Brass anchor screw
- 4 Wooden door

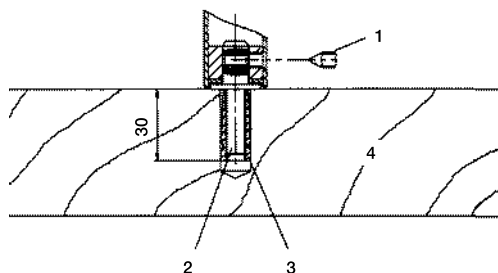

## X 5554

For installing a pair of pull handles on a wooden door, thicknesses:

- 45-60mm (1.3/4"-2.3/8"): X 0509-70
- 60-75mm (2.3/8"-2.15/16"): X 0509-85
- 75-90mm (2.15/16"-3.9/16"): X 0509-100

- 1 M6 grub screw
- 2 M8 special screw
- 3 Wooden door

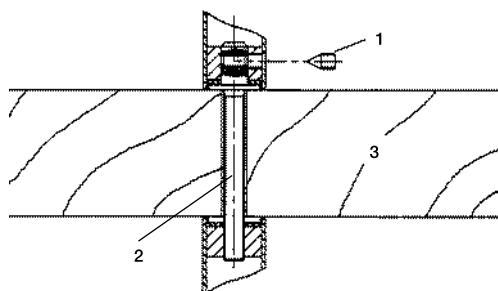

## X 5553

For installing a single pull handle on a wooden door, thicknesses:

- 45-60mm (1.3/4"-2.3/8"): X 0508-75
- 60-75mm (2.3/8"-2.15/16"): X 0508-90
- 75-90mm (2.15/16"-3.9/16"): X 0508-105

### Finish

Satin  
 Polished

- 1 M8 screw
- 2 Wooden door
- 3 Screw covering rosette

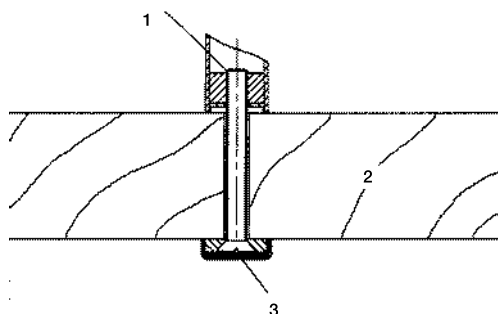

# Stainless steel door pulls installation

## X 5552

For installing a pair of pull handles on a glass door, thickness 8-12mm (5/16"-1/2")

- 1 M6 grub screw
- 2 M8 special screw
- 3 Glass

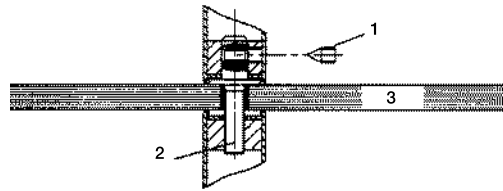

Suggested hole  $\varnothing$  11 mm (7/16")

## X 5551

For installing a single pull handle on a glass door, thickness 8-12mm (5/16"-1/2")

**Finish**  
Satin  
Polished

- 1 M8 screw
- 2 Screw covering rosette
- 3 Glass

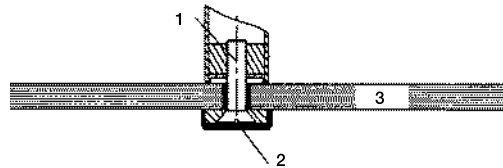

Suggested hole  $\varnothing$  11 mm (7/16")

## X 0552

For installing a single pull handle without screw-covering rosettes on an aluminum door. For item.

- P 5405 S 25
- P 5406 S 25
- P 5408 S 25

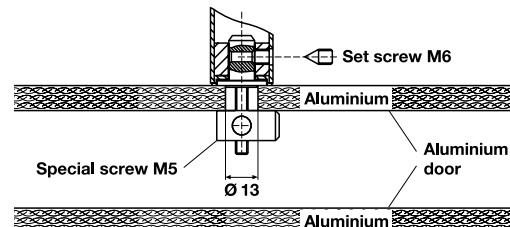

# Window lever application

**X 0601**  
 Movement 4 click  
 positions

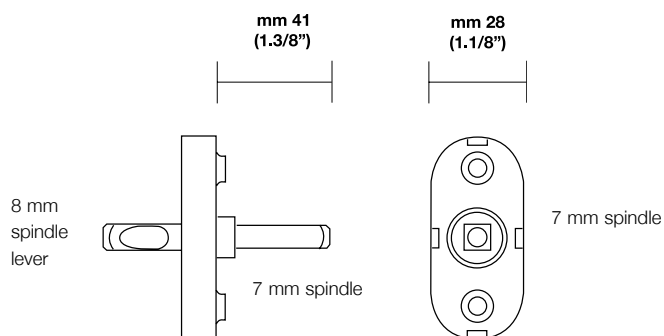

# Dummy set adaptor

Round Rose - Solid Brass

**X003/1 Double RP**

Set includes: 2 underosettes, 1 latch bolt blank  
 BACKSET 2.3/4" and 2.3/8"  
 Retail price \$ 75.00

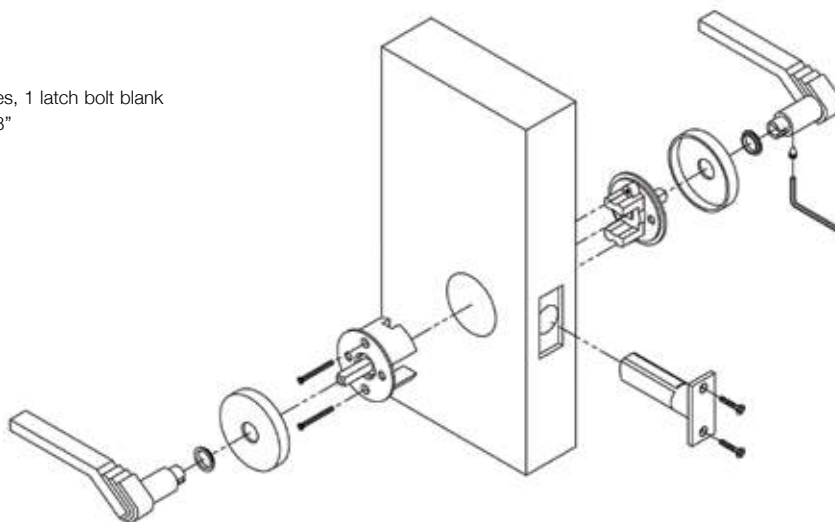

**X003/2 Single RP**

Set includes: 1 underosettes, 1 latch bolt blank  
 finished solid brass rosette for opposite side available  
 in 26/chrome finish  
 BACKSET 2.3/4" and 2.3/8"  
 Retail price \$ 90.00

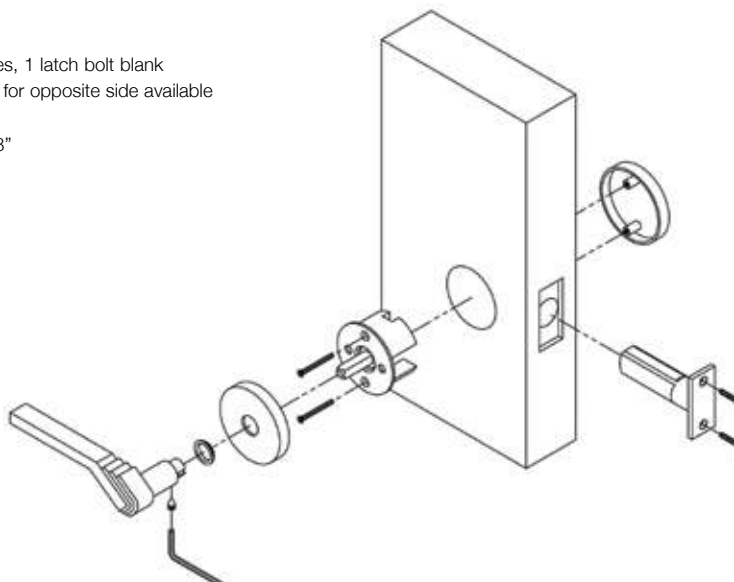



# Dummy set adaptor

Square Rose - Solid Brass

## X003/1 Double RQ

Set includes: 2 underosettes, 1 latch bolt blank  
BACKSET 2.3/4" and 2.3/8"

Retail price \$ 75.00

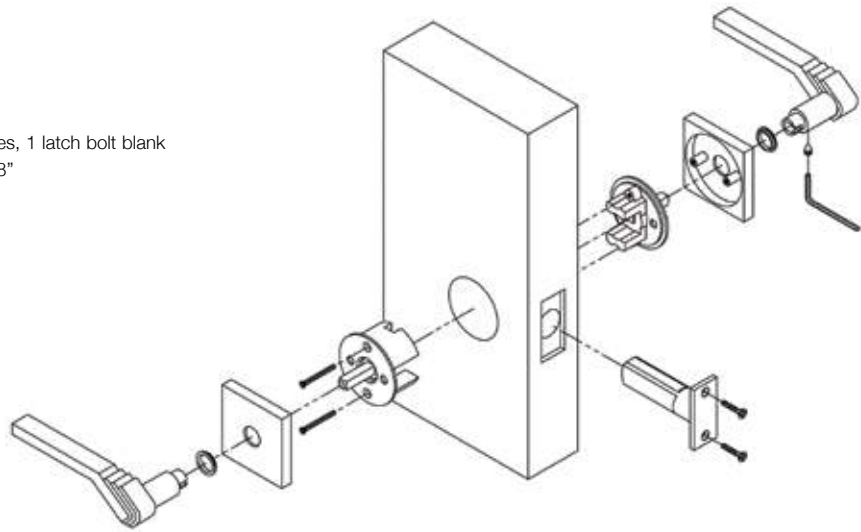

## X003/2 Single RQ

Set includes: 1 underosette, 1 latch bolt blank  
finished solid brass rosette for opposite side available  
in 26/chrome finish

BACKSET 2.3/4" and 2.3/8"

Retail price \$ 90.00

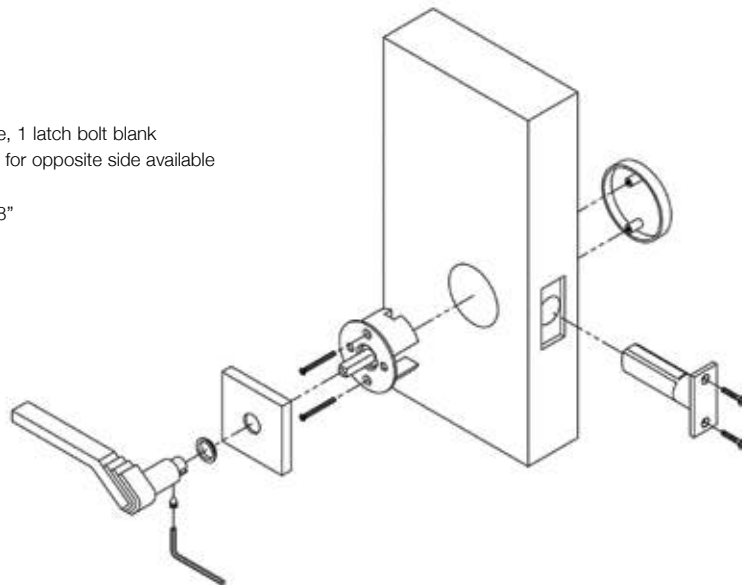

# Dummy set adaptor

Round Rose - Stainless Steel

## X003/1 Double RPS

Set includes: 2 underosettes, 1 latch bolt blank  
BACKSET 2.3/4" and 2.3/8"

Retail price \$ 75.00

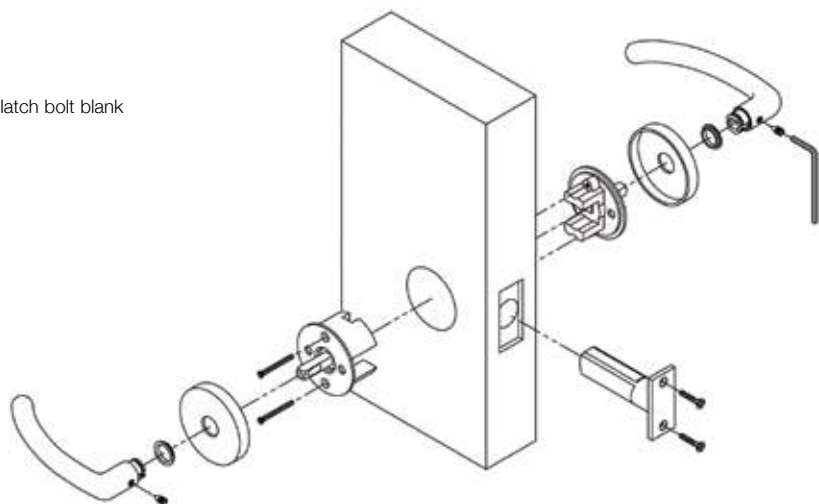

# Dummy set adaptor

Round Rose - Stainless Steel

## X003/2 Single RPS

Set includes: 2 underosettes, 1 latch bolt blank  
 finished solid brass rosette for opposite side  
 available in 26/chrome finish  
 BACKSET 2.3/4" and 2.3/8"  
 Retail price \$ 90.00

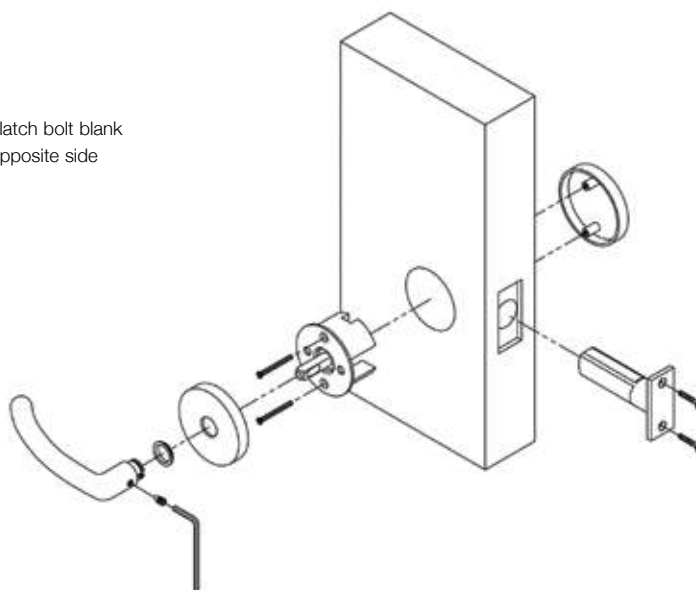

# Dummy set adaptor

Square Rose - Stainless Steel

## X003/1 Double RQS

Set includes: 2 underosettes, 1 latch bolt blank  
 BACKSET 2.3/4" and 2.3/8"  
 Retail price \$ 75.00

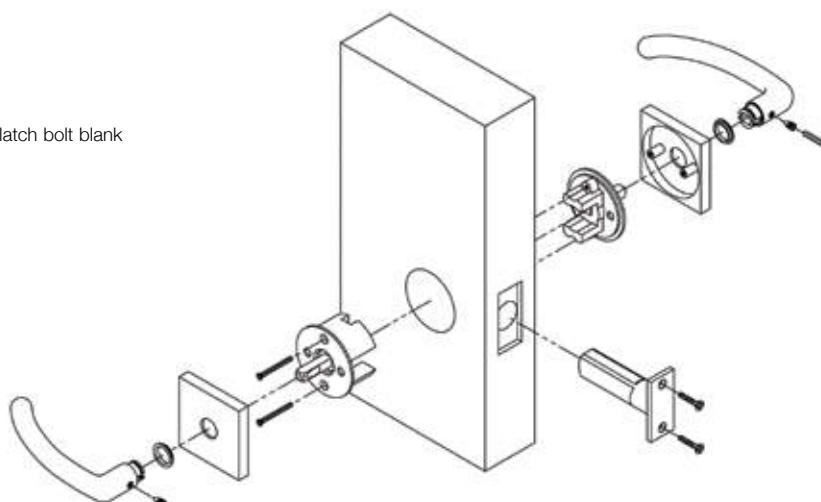

## X003/2 Single RQS

Set includes: 1 underosette, 1 latch bolt blank  
 finished solid brass rosette for opposite side available  
 in 26/chrome finish  
 BACKSET 2.3/4" and 2.3/8"  
 Retail price \$ 90.00

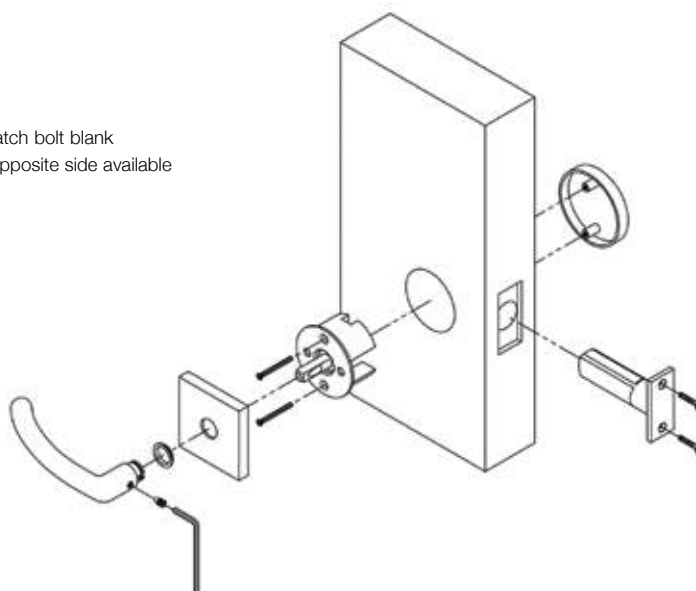

# Interior sets

## INTERIOR SETS WITH ROUND ROSETTES AND LONG ESCUTCHEON PLATES

**Passage** FIG. 1 (shown with RS small rosette trim) FIG. 2 (shown with RSQ small rosette trim)  
Reversible for right and left handed doors.

**Privacy** FIGS. 3 and 5

Rosette trim is reversible for right and left handed doors. Escutcheon plates require door handing to be specified. Integral push button privacy features inside panic release function and outside emergency release. NEP (narrow long escutcheon plates) use a privacy bolt. Privacy bolt also available as a function (see deadbolt specifications).

**Dummy** FIG. 4

Must specify door handing for single dummy. Surface mounted spindle (X0571) or opposing spindle (X0572) available. Escutcheon plates with single dummy will have exposed mounting screws. Full dummy sets specified with R/L have exposed mounting screws on the interior only.

### Rosette Trim

RT	Traditional style 2.9/16" (65mm) dia.
RP	Plain style 2.9/16" (65mm) dia.
RQ	Square style 2.9/16" (65mm) dia.
RS	Plain style 1.3/4" (45mm) dia.
RSQ	Square rosette (small) 1.3/4" (45mm)

Standard rosette (RT, RP, RQ) supplied is 2.9/16" (65mm).  
For 1.3/4" (45mm) small rosettes (RS, RSQ), please specify.

NOTE: The RS, RSQ rosettes can only be used for new doors which do not have a 2.1/8" cross bore hole. Privacy sets require a separate privacy bolt (105 RSP, 105 RSQ). No integral privacy sets are available with RS, RSQ rosettes. Heavy-duty springs attached to the rosette and lever provide added strength and durability. (Not supplied with knob sets.) All rosette trims have concealed mounting screws.

### Escutcheon Plates FIG. 3

ET	Traditional style
EP	Plain style
ER	Rectangular style
NEP	Narrow style
NER	Narrow Rectangular Style

ET, EP, ER, escutcheon plate styles will cover a 2.1/8" cross bore hole. Heavy-duty, spring-loaded housings (X2124M) are included for added strength and durability. (Not supplied with knob sets.) NEP, NER trim has springs attached to the escutcheon and lever.

### Door Thickness

Standard = 1.3/8" to 1.3/4".  
For any other size, please specify.

### Backset

Standard = 2.3/8". For 2.3/4" please specify.  
2" backset is also available for passage sets only. 03/brass finish only.

### Latch Bolt

1/2" throw with a 2.1/4" x 1" face plate.  
8 mm square hub size.  
28 degree latch reversible

### Strike Plate

Standard = T-strike 2.3/4" x 1.1/8" Lip size = 1.1/4"  
Full lip strikes are available upon special request.  
Square corner.

### Cross Bore

Fits in any standard 2.1/8" cross bore hole with a 1" edge bore.  
RS rosettes and NEP narrow long escutcheon plates require a 5/8" cross bore hole.

### Dust Box

Included.

**Figure 1**  
 Passage Function  
 RS trim

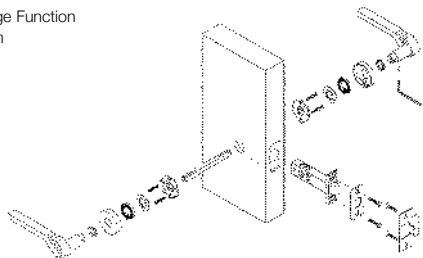

**Figure 2**  
 Passage Function  
 RSQ Trim

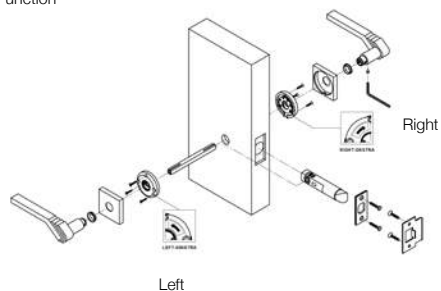

**Figure 3**  
 Privacy Function  
 For long escutcheon plates  
 EP trim

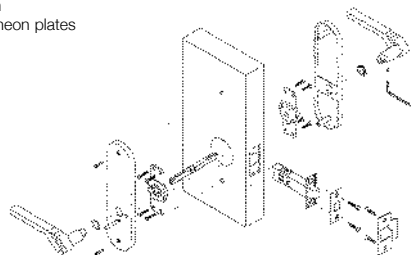

**Figure 4**  
 Dummy Trim  
 For Rosette and Escutcheon

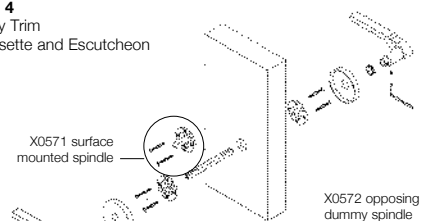

**Figure 5**  
 Privacy Function  
 RQ trim

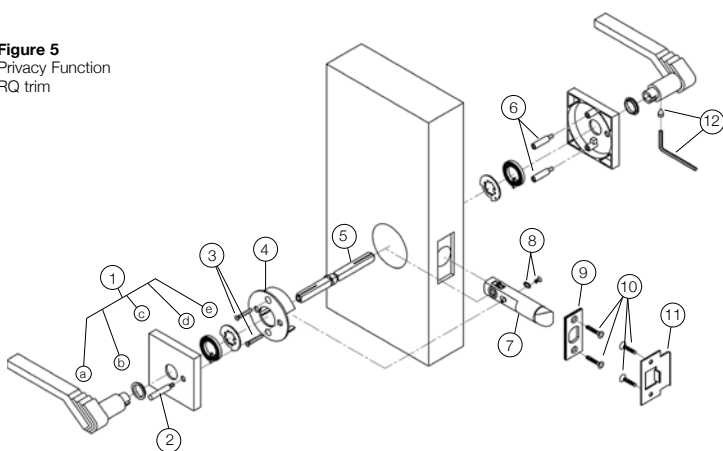

**Parts List**

1. Lever & Rosette Assemblies(2) includes:
  - a) lever
  - b) nylon washer
  - c) rosette
  - d) spring
  - e) retaining ring
2. Privacy Pin (1)
3. Through Screws (2)
4. Housing (1)
5. Two Piece Spindle (1)
6. Post Extensions (2) Rosette Stabilizers (2)
7. Latch (1)
8. Screw & Washer for Handling (1)
9. Face Plate (1)
10. Wood Screws (4)
11. Strike Plate (1)
12. Allen Wrench with 2 Set Screws (1)

# Deadbolts

## DEADBOLTS

### Functions

Single Cylinder (101 RP) FIG. 6 (101 RQ) FIG. 10. Feature low profile trim (FIG. 9) designs which coordinate with all of our lever and knob styles. Include concealed mounting screws.

### Styles

RT Traditional  
RP Plain  
RQ Square

### Door Thickness

Standard = 1.3/4". For 1.3/8" doors or any other size, please specify.

### Backset

Standard = 2.3/8". For 2.3/4" please specify.

2" backset is also available upon special request. 03/brass finish only.

### Latch Bolt

1" throw with two hardened steel rods inside bolt for added security to resist sawing.

### Latch face

2" and 2.3/8" backset = 2.1/4" x 1"

2.3/4" backset = 2.1/4" x 1.1/8"

### Strike Plate

2.3/4" x 1.1/8" heavy duty for both wood and metal door jambs. Square corner.

### Cross Bore

Deadbolts fit into a standard 2.1/8" cross bore hole with a 1" edge bore.

### Cylinder

Solid brass, 5-pin, mortise cylinder with C-keyway.

## PRIVACY BOLTS

### Styles

105 RST=Traditional 105 RSP=Plain 105/K1225 RSQ FIG. 7 105 RSQ=SQUARE

Decorative thumbturn with emergency coin key release on exterior. Include concealed mounting screws.

Privacy bolts are also available with escutcheon plates (specify 106).

### Door Thickness

Standard=1.3/4". For 1.3/8" or any other size, please specify.

### Backset

Standard=2.3/8". For 2.3/4" please specify.

### Latch Bolt

1/2" throw with 2.1/4" x 1" face plate.

### Strike Plate

2.3/4" x 1.1/8". Square corner.

## ESCUTCHEONS WITH DEADBOLTS

### Functions

Passage with single cylinder (103) FIG. 8 or double cylinder (104) deadbolt.

Dummy available to match refer to interior sets. Escutcheon plates are also available with a privacy bolt (specify 106).

NEP plates not available with deadbolts.

### Styles

ET Traditional style  
EP Plain style  
ER Rectangular style

Escutcheon plate styles will cover a 2.1/8" cross bore hole. Heavy-duty, spring-loaded housings (X2124M) are included for added strength and durability. (Not supplied with knob sets.)

### Door Thickness

Standard=1.3/4". For 1.3/8" doors or any other size, please specify.

### Backset

Standard=2.3/8". For 2.3/4" please specify.

### Passage Latch

1/2" throw with a 2.1/4" x 1" face plate. 8mm square hub size.

### Deadbolt Latch

1" throw with two hardened steel rods inside bolt for added security to resist sawing.

2.3/8" backset has a 2.1/4" x 1" face plate.

2.3/4" backset has a 2.1/4" x 1.1/8" face plate.

### Strike plates

Passage latch=T-strike 2.3/4" x 1.1/8" Lip size=1.1/4".

Deadbolt latch=2.3/4" x 1.1/8" heavy duty for wood and metal door jambs.

### Cross Bores

Passage and deadbolt latches fit any standard 2.1/8" cross bore hole.

Both latches require a standard 1" edge bore.

### Cylinder

Solid brass, 5-pin, mortise cylinder with C-keyway.

**Figure 6**  
 Single Cylinder  
 101 RP trim

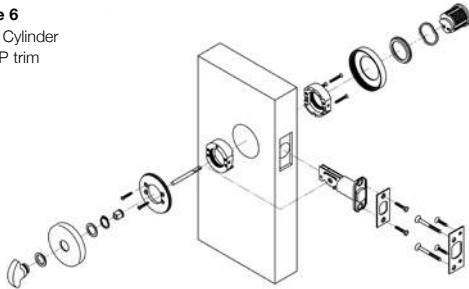

**Figure 7**  
 Privacy Bolt 105/K 1225  
 RSQ trim

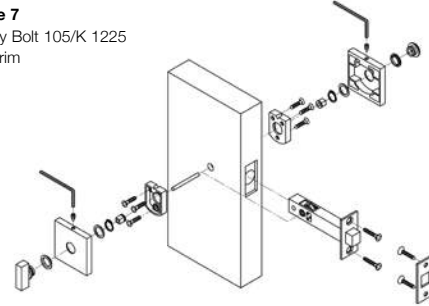

**Figure 8**  
 Escutcheon with deadbolt  
 103 EP trim

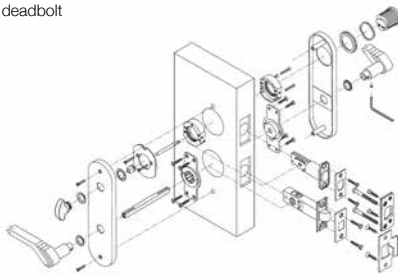

**Figure 9**  
 Single Cylinder deadbolt 101

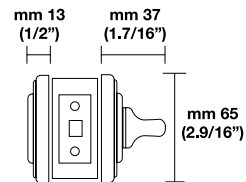

**Figure 10**  
 Model Single Cylinder deadbolt  
 101 RQ trim

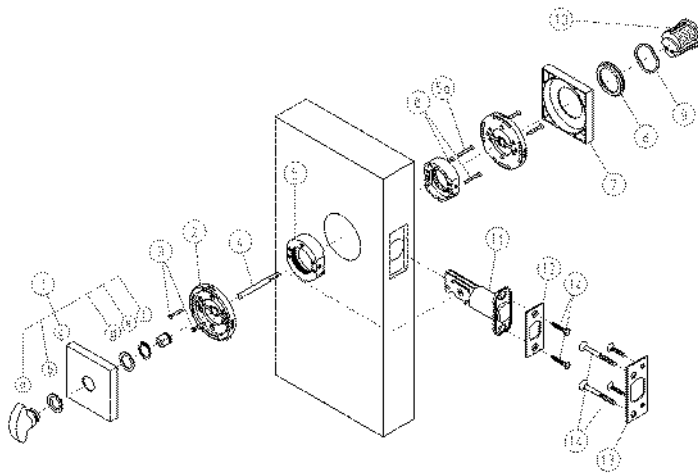

**Parts List**

1. Interior Rosette (1) includes:
  - a) thumbturn
  - b) nylon washer
  - c) rosette
  - d) metal washer
  - e) C-clip
  - f) nylon bushing
2. Under rosette (2)
3. 5/8" screws for under rosette (2)
4. Tailpiece (1)
5. Cylinder housing (1) includes 1.1/8" housing assembly screw
6. 1.1/8" cylinder housing screws (2)
7. Exterior rosette (1)
8. Cylinder collar (1)
9. Wave washer (1)
10. Cylinder with 2 keys (1)
11. Latch (1)
12. Face plate (1)
13. Strike plate (1)
14. Wood screws (6)
15. Allen wrench (not illustrated) (1)

# Mortise locks

Lever and Knob sets with rosette trim (specify RT, RP, RQ, RS) FIG.11 and 12.

Lever and Knob sets with long escutcheon trim (specify ET, EP, ER, NES) For figures refer on page 89-91. FIG. 13

**Entry Handlesets** FIG. 14

## Trim definitions

RT	Traditional rosette trim	ET	Traditional escutcheon plate trim
RP	Plain rosette trim	ER	Rectangular escutcheon plate trim
RQ	Square rosette trim	EP	Plain escutcheon plate trim
RS	Plain rosette trim (small)		
RSQ	Square rosette (small)		

## Door Thickness

Standard=1.3/4". For any other size, please specify.

## Backset

FIG. 17B

2.1/2" or 2.3/4" standard, please specify.

NOTE: H function only available with long escutcheon plates. Custom backsets and other sizes are available upon special request.

## Narrow Backset

1.1/2", 1.3/4", 2", 2.1/4" available on request

## Latch Bolt

Solid brass with anti-friction latch, 3/4" throw, reversible.

Standard bolt finish is Satin Brass (03D), Satin Chrome (26D). Retract=28°

## Deadbolt

Brass with hardened steel inserts, 1" throw.

Standard bolt finish is Satin Brass (03D), Satin Chrome (26D).

## Lock Front

Adjustable bevel, brass or stainless steel armor front. Standard front=8" x 1.1/4". FIG. 17A

## Strike Plate

4.7/8" x 1.1/4" Curved lip FIG. 17C

## Door Preparation

ANSI Specifications, A115.1. Templates and instructions are provided for all functions.

## Cylinder

Solid brass, 5-pin, mortise cylinder with C-keyway.

## Handing

Please specify: RH, LH, RHR, LHR. Refer to handing chart on page 123.

## Performance Specifications

ANSI A 156.13, Grade 1, UL Listed, 3 hour fire rating.

## Case

Heavy gauge plated steel.

## Hubs

5/16" (8mm) square.

## Dust Box

Included.

**Figure 11**  
ML F RQ trim

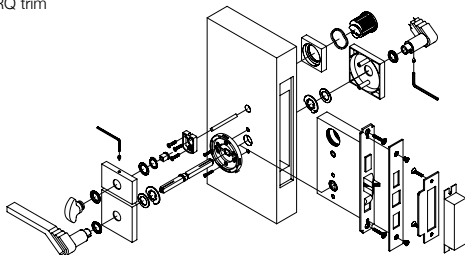

**Figure 12**  
ML F RP trim

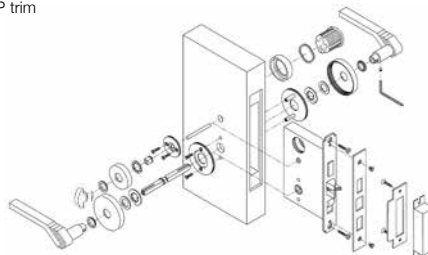

**Figure 13**  
ML F ER trim

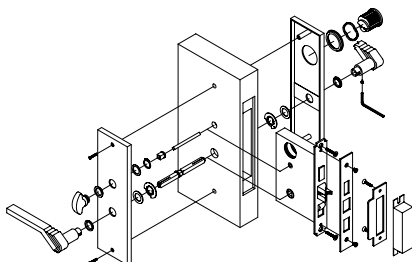

**Figure 14**  
ML TP F Entry Handleset

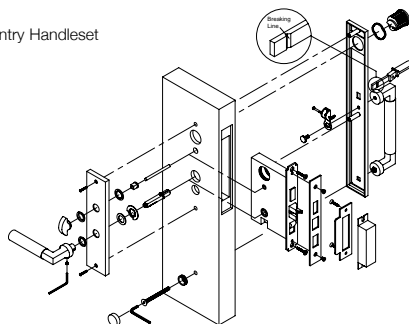

**Figure 17A**

Lock front

shown ML FD function

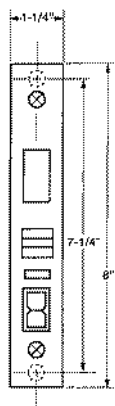
**Figure 17B**

Lock body

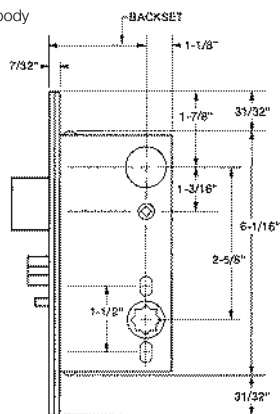
**Figure 17C**

Strike plate

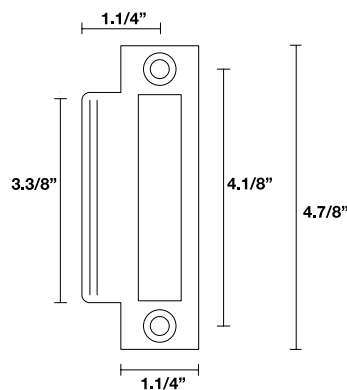
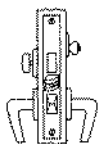
**FUNCTIONS**

**F ENTRANCE**

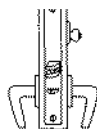
Latch bolt by key outside and lever either side unless outside lever is locked by toggle-action stop. Dead bolt by key outside and turnpiece inside. Turning inside lever retracts latch and dead bolt simultaneously. Outside lever remains locked.

**EW STOREROOM - ELEC ELECTRIFIED**

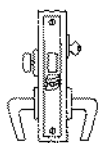
Latch by lever inside and key outside. Outside lever is always rigid. Auxiliary latch deadlocks latch bolt.

**FW ENTRANCE**

Latch bolt by lever either side. Dead bolt by key outside and turnpiece inside. A turn of inside lever retracts latch and dead bolt simultaneously-automatically unlocking outside lever. No Toggle.

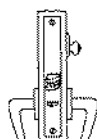
**ML ELEC**

Call factory for additional specification required.

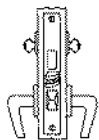
**AC ENTRANCE**

Latch bolt by lever either side unless outside lever is locked by toggle action stop. Dead bolt by key either side.

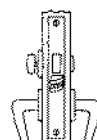
**J CLASSROOM**

Latch bolt by key outside and lever either side unless outside lever is locked by key outside. Auxiliary latch deadlocks latch bolt.

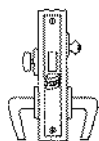
**B ENTRANCE**

Latch bolt by lever either side. Dead bolt by key outside and thumbturn inside. No Toggle. No emergency egress.

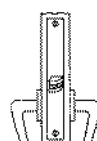
**LF PRIVACY**

Latch bolt by lever either side. Dead bolt by turnpiece inside and coin key outside. A turn of inside lever retracts latch and dead bolt simultaneously-automatically unlocking outside lever.

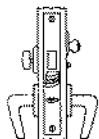
**H HOTEL**

Latch bolt by lever inside and guest or master key outside. Outside lever always rigid. Dead bolt by turnpiece inside and key outside. A turn of inside lever retracts latch and dead bolt simultaneously. Auxiliary latch deadlocks latch bolt.

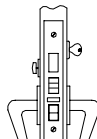
**ML FD ENTRANCE OR APARTMENT LOCK**

Latch bolt by key outside and lever either side. Unless outside lever is locked by toggle-action stop. Dead bolt by key outside and turnpiece inside. Turning inside lever retracts latch and dead bolt simultaneously. Outside lever remains locked. Auxiliary latch deadlocks latch bolt and prevents manipulation of locked toggle action stop.

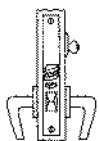
**E OFFICE**

Latch bolt by key outside and lever either side unless outside lever is locked by toggle-action stop. Auxiliary latch deadlocks latch bolt.

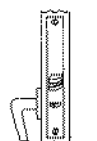
**NC COMMUNICATING**

Latch bolt by lever one side.

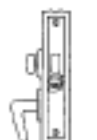
**LF-C COMMUNICATING**

Latch bolt by lever inside only. Dead bolt by turnpiece inside only. A turn of inside lever retracts latch and dead bolt simultaneously-automatically unlocking door.



# Mortise locks narrow backset

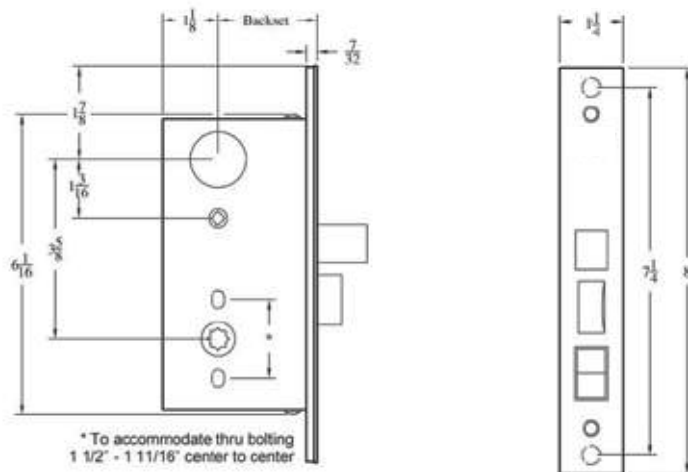

## FUNCTIONS

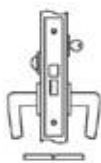

**ML FW Entrance**  
 Latch bolt by lever either side  
 Dead bolt by key outside and turn piece inside  
 A turn of inside lever retracts latch and dead bolt simultaneously, automatically unlocking outside lever

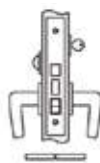

**ML F Entrance**  
 Latch bolt by key outside and lever either side unless outside lever is locked by toggle action stop  
 Dead bolt by key outside and turn piece inside  
 Turning inside lever retracts latch and dead bolt simultaneously  
 Outside lever remains locked until manually unlocked by toggle

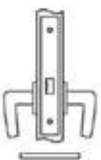

**ML N Passage**  
 Latch bolt by lever either side

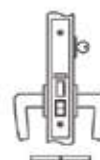

**ML E Office**  
 Latch bolt by key outside and lever either side unless outside lever is locked by toggle-action stop  
 Auxillary latch deadlocks latch bolt

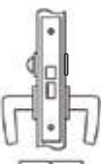

**ML LF Privacy**  
 Latch bolt by lever either side  
 Dead bolt by turn piece inside and optional emergency key outside  
 A turn of inside lever retracts latch and dead bolt simultaneously—automatically unlocking outside lever

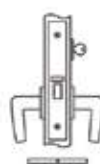

**ML EW Storeroom**  
 Latch by lever inside and key outside  
 Outside lever always RIGID  
 Auxillary latch deadlocks latchbolt

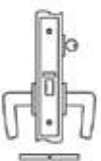

**ML J Classroom**  
 Latch bolt by key outside and lever either side unless outside lever is locked by key  
 Auxillary latch deadlocks latch bolt



# Stainless steel door hardware

## STAINLESS STEEL DOOR HARDWARE - INTERIOR SETS

### Passage FIG. 18 (shown with RSS small rosette trim)

RSS, RPS, and RQS rosette trims are reversible for right and left handed doors.

NES (narrow long escutcheon plates). Must specify door handing.

NERS narrow long rectangular escutcheon plate multi point. Must specify door handing.

### Privacy FIG.s 19, 20, 21 (shown with RQS, ERS, NES trims)

RPS and RQS are reversible for right and left handed doors.

Integral push button privacy features inside panic release function and outside emergency release.

ERS rectangular escutcheon FIG. 20

RSS (small rosette) trim is supplied with a privacy bolt (105 RSS) FIG. 23

NERS Narrow long rectangular escutcheon plate multi point. Must specify door handing.

NES (narrow long escutcheon plates) are supplied with a privacy bolt.

NES (narrow long escutcheon plates). Must specify door handing.

### Dummy FIG. 22 (for RSS, RPS, ERS, RSQ, NES trims)

Must specify door handing for single dummy.

Surface mounted spindle (X0571) or opposing spindle (X0572) available.

ERS/NES (narrow long escutcheon plates) with single dummy will have exposed mounting screws.

Full dummy sets specified with R/L have exposed mounting screws on the interior only.

### Rosette Trim

RSS Plain style 2" (50mm) dia. (Not recommended for heavily used doors)

RPS Plain style 2.9/16" (65mm) dia.

RQS Square style 2.9/16" (65mm) dia.

Please specify RPS, RQS or RSS for rosette.

### Long Escutcheon Plate Trim

NES Plain style (see page 90/91 for dimensions)

NOTE: RSS (small rosettes) and NES (narrow long escutcheon plates) can only be used for new doors which do not have a 2.1/8" cross bore hole. Privacy sets require a separate privacy bolt.

NERS Narrow long rectangular escutcheon plate multi point

ERS Rectangular escutcheon plate

Heavy duty springs attached to the rosettes or escutcheons and levers provide added strength and durability (Not supplied with knob sets). All rosette trims have concealed mounting screws.

### Door Thickness

Standard = 1.3/4". For any other size, please specify.

### Backset

Standard = 2.3/8". For 2.3/4" please specify.

### Cross Bore

RPS, RQS rosette, ERS escutcheon trim fits in any standard 2.1/8" cross bore hole with a 1" edge bore.

RSS, RSQS rosettes and NES narrow long escutcheon plates require a 5/8" cross bore hole.

### Latch Bolt

1/2" throw with 2.1/4" x 1" face plate. 8mm square hub size.

### Dust Box

Included.

### Strike Plate

Standard = T-strike 2.3/4" x 1.1/8". Lip size = 1.1/4"

Full lip strikes are available upon special request.

Square corner.

NOTE: Face plate, T-strike and screws are solid brass plated in satin nickel (15) or polished chrome (26) finishes.

**Figure 18**  
Passage Function  
RSS trim

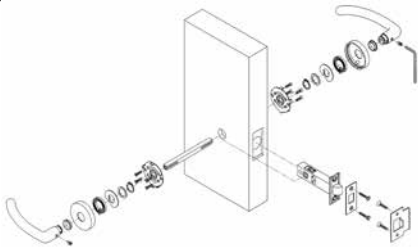

**Figure 19**  
Privacy Function  
RQS trim

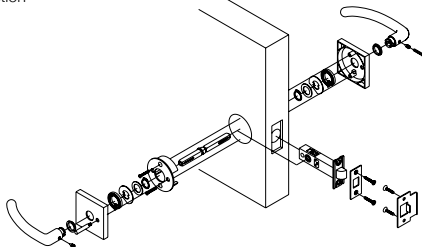

**Figure 20**  
Privacy Function  
ERS trim

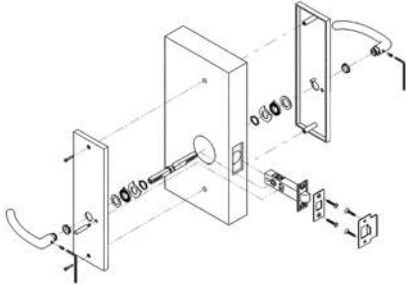

**Figure 21**  
Privacy Function  
NES trim

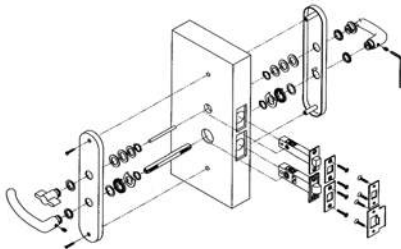

**Figure 22**  
Dummy RSQ trim

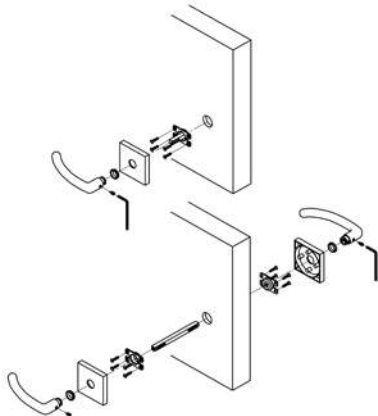

**Figure 23**  
Privacy Bolt  
105 RSS trim

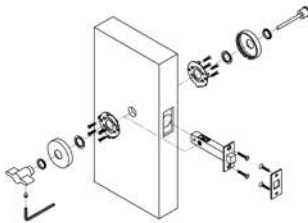

# Stainless steel door hardware

## STAINLESS STEEL DOOR HARDWARE - EXTERIOR SETS

### Privacy Bolt FIG. 24

105 RSS, 105 RSQS = Thumbturn and emergency release trim with latch bolt.  
105 RSS L/E, 105 RSQS L/E = Thumbturn with latch bolt. (no exterior trim)  
Decorative thumbturn with coin key emergency release on exterior. Includes concealed mounting screws.

### Deadbolts FIG. 25

Single Cylinder (101 RPS, 101 RQS)  
Double cylinder (102 RPS, 102 RQS)  
Features low profile trim (see FIG.9 on page 98) designs, which coordinate with all of our stainless steel lever and knob styles. Includes concealed mounting screws.

### Door Thickness

Standard = 1.3/4". For any other size please specify.

### Mortise Locks

FIG. 26 (ERS trim) FIG. 27 (RPS trim) FIG. 28 (NES trim)  
For mortise lock specifications and lock information, please see page 136-137.  
Face and strike plates are satin stainless steel for 32D finish.  
Polished stainless steel (32) finish uses a chrome plated solid brass lock front and strike plate.  
Mortise lock trim is designed to fit most mortise lock manufacturers.  
Please call factory for more information.

### Rosette Trim

RSS = Plain style 2" (50mm) dia. (not recommended for heavily used doors.)  
RPS = Plain style 2.9/16" (65mm) dia.  
RSQS = Square style 1.3/4" (45mm) (not recommended for heavily used doors.)  
RQS = Square style 2.9/16" (65mm) dia.

### Long Escutcheon Plate Trim

NERS = Narrow rectangular escutcheon (see page 112 for dimensions)  
NES = Narrow plain style (see page 90/91 for dimensions)  
ERS = Rectangular style (see page 90/91 for dimensions)

### Door Thickness

Privacy Bolt - Standard = 1.3/4". For 1.3/8" or larger than 1.3/4, please specify.  
Deadbolt - Standard = 1.3/4". For 1.3/8" or larger than 1.3/4", please specify.  
Mortise Lock - Standard = 1.3/4" For 1.3/8" or larger than 1.3/4", please specify.  
For any other sizes, please specify.

### Backsets

Privacy Bolt - Standard = 2.3/8". For 2.3/4" please specify.  
Deadbolt - Standard = 2.3/8". For 2" or 2.3/4" please specify.  
Mortise Locks - Must specify 2.1/2" or 2.3/4". Additional sizes are available upon request.

### Door Preparation

Privacy Bolt requires a 5/8" cross bore hole with a 1" edge bore hole.  
Deadbolt requires a standard 2.1/8" cross bore hole with a 1" edge bore hole.  
Mortise Locks. Templates and instructions are provided for all functions.

### Cylinders

Solid Brass, 5-pin, mortise cylinder with C-keyway.

### Dust Box

Included.

For more technical information please see the following pages:

Privacy Bolts - page 134  
Deadbolts - page 134  
Mortise Locks - page 136-137

**Figure 24**  
Privacy Bolt  
105 RSQS

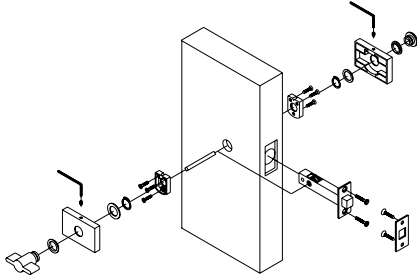

**Figure 25**  
Deadbolt Single Cylinder  
101 RPS

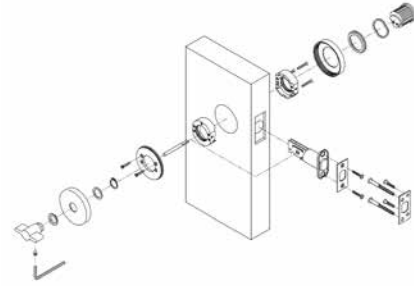

**Figure 26**  
ML F  
ERS trim

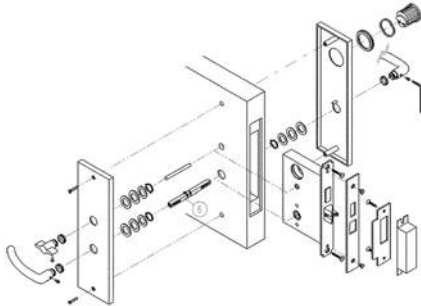

**Figure 27**  
ML F  
RPS trim

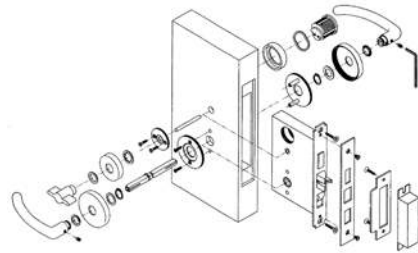

**Figure 28**  
ML F  
NES trim

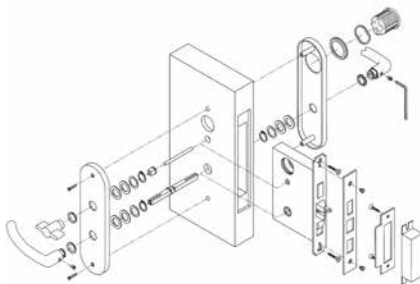

# Multi-Point Hardware

## Trim Options

- RSM Plain style rosette, 1,3/4" (45mm) dia. Solid brass. FIG. 32
  - RSSM Plain style rosette, 2" (50mm) dia. Stainless steel. Available in 32D finish only.
  - NEP Narrow long escutcheon plates. Solid brass.
  - NER Narrow long rectangular escutcheon plate. Solid brass.
  - NERS Narrow long rectangular escutcheon plate. Stainless steel. Available in 32D finish only.
  - NES Narrow long escutcheon plates. Stainless steel. Available in 32D finish only.
- RSM and RSSM trims include a profile cylinder with coordinated rosettes. For NEP/NES specifications see page 112.

## Functions

- EAB Entry function with American cylinder below the lever, 92mm center to center. FIG. 29
- PAB Patio function with the interior thumbturn below the lever, no keyway on the exterior plate.
- EAA Entry function with American cylinder above the lever, 92mm center to center. FIG. 30
- PAA Patio function with the interior thumbturn above the lever, no keyway on the exterior plate.
- EE Entry function with profile cylinder, 92mm center to center. FIG. 31
- PE Patio function with 1/2 profile cylinder & thumbturn, no keyway on the exterior plate.
- CE Custom entry function with special center to center sizes. Uses a profile cylinder.
- DA Active dummy pair.
- DS Single dummy, surface mounted spindle.

## Door Thickness

Standard = 1,3/4". We can also accommodate 2,1/4". Please call factory.

## Cylinders

Profile and American type cylinders are all solid brass construction, 5-pin with C-keyways.

## Spindle

8mm square.

## Handing

Handing is required for all multi-point hardware. Please specify RH or LH.

Refer to the handing chart on page 123.

## Finishes

RSM and NEP trims are stocked in polished brass (03) and satin nickel (15) finishes. NER trim stocked in polished chrome (26) and satin chrome (26D).

Custom finishes are available upon special request. Call factory for quotation.

RSSM, NES and NERS trims are stocked in satin stainless steel (32D) only. No custom plating on any stainless steel products.

**Figure 29**  
Entry EAB Function  
NEP trim

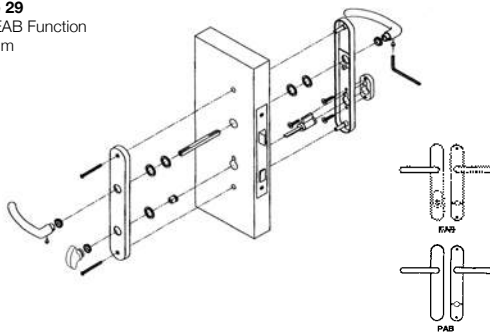

**Figure 30**  
Entry EAA Function  
NEP trim

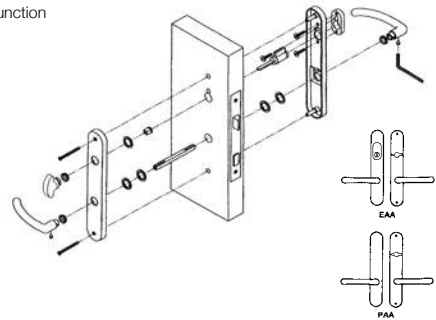

**Figure 31**  
Entry EE Function  
NEP trim

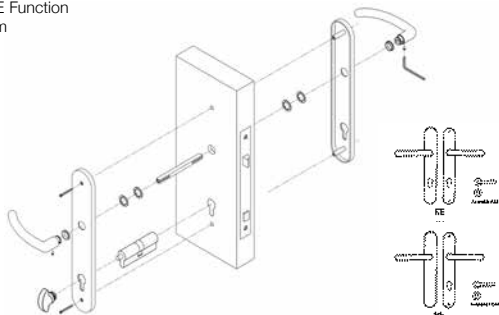

**Figure 32**  
Entry EE Function  
RSM trim

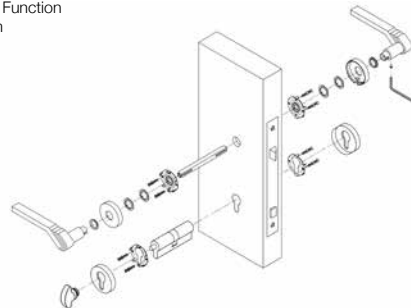

# Narrow long escutcheon plates

## INTERIOR SETS

**Passage** FIG.33 (shown with NES plates)  
 Must specify handing.

**Privacy** FIG.34 (NES trim) and FIG.35 (NEP trim)  
 Must specify handing.

Privacy function uses a privacy bolt. Integral privacy is not available with NEP or NES trim plates.  
 NOTE: NEP privacy bolt is below the lever. FIG. 35. NES privacy bolt is above the lever. FIG. 34.

**Dummy** FIG.36 and FIG.37

Must specify handing. Surface mounted spindles (X0571) for NES and (X0571 DMY SQ) for NEP.  
 Opposing dummy spindle available for NES, NEP (X0572). NEP and NES plates with a single dummy will have exposed mounting screws on the interior only. Full dummy sets specified with R/L have exposed mounting screws on the interior only.

### Trim Options

- NEP Narrow long escutcheon plates. Solid brass. For specifications see page 108.
- NES Plain long narrow escutcheon plates. Stainless steel. For specifications see page 108.
- NER Narrow long rectangular escutcheon plate. Solid brass. For specifications see page 108.
- NERS Narrow long rectangular escutcheon plate. Stainless steel. For specifications see page 108.

### Door Thickness

Standard = 1.3/4". For any other size, please specify.

### Backset

Standard = 2.3/8". For 2.3/4" please specify.

### Latch Bolt

1/2" throw with 2.1/4" x 1" face plate. 8mm square hub size (tubular latch).

### Strike Plate

Standard = T-strike 2.3/4" x 1.1/8". Lip size = 1.1/4" (tubular latch)

Full lip strikes are available upon special request. Square corner.

**Figure 33**  
 Passage Function  
 NES trim

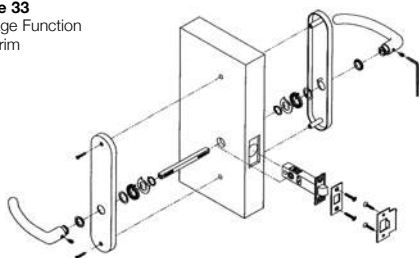

**Figure 34**  
 Privacy Function  
 NES trim

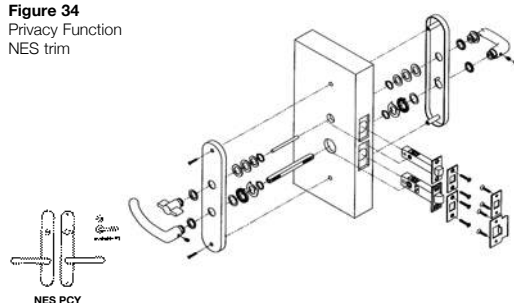

**Figure 35**  
 Privacy Function  
 NEP trim

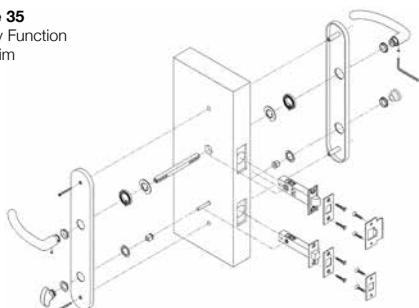

**Figure 36**  
 Dummy Single  
 NEP trim

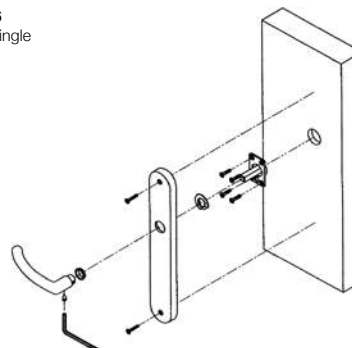

**Figure 37**  
 Dummy Pair  
 NES trim

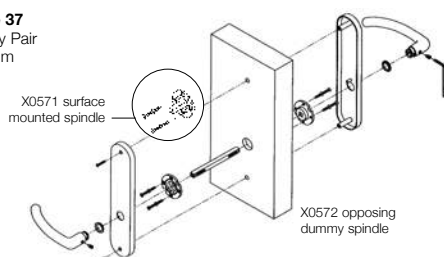



# Installation templates

**TRIM: RP - RT - RPS - RQ - RQS**

**Valli&Valli** (U.S.A.) INC.

**ROUND ROSETTE LOCKSET AND DEADBOLT INSTALLATION TEMPLATE**

**IMPORTANT NOTE**

If door is beveled, place template on low side of door bevel. Determine before drilling, length of latch enclosed for proper backset installation. Read instruction sheet before installing lock.  
Mark proper center for 2.1/8" diameter cross bore hole according to lockset requirement.

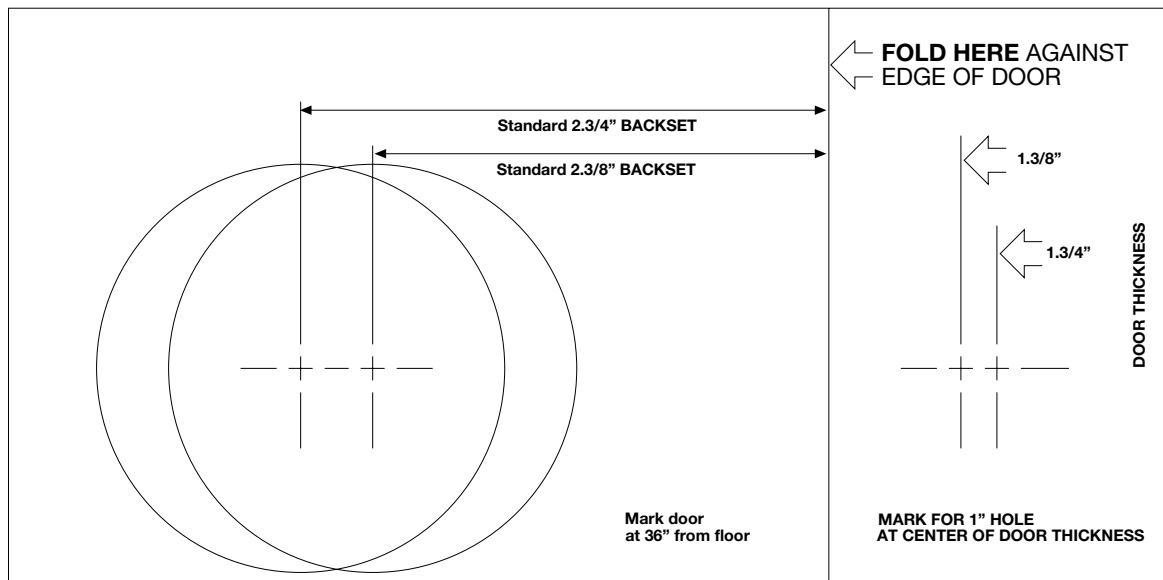

**TRIM: RS - RSS - RSQS - 105**

**Valli&Valli** (U.S.A.) INC.

**ROUND ROSETTE LOCKSET INSTALLATION TEMPLATE**

**IMPORTANT NOTE**

If door is beveled, place template on low side of door bevel. Determine before drilling, length of latch enclosed for proper backset installation. Read instruction sheet before installing lock.  
Mark proper center for 5/8" diameter cross bore hole according to lockset requirement.

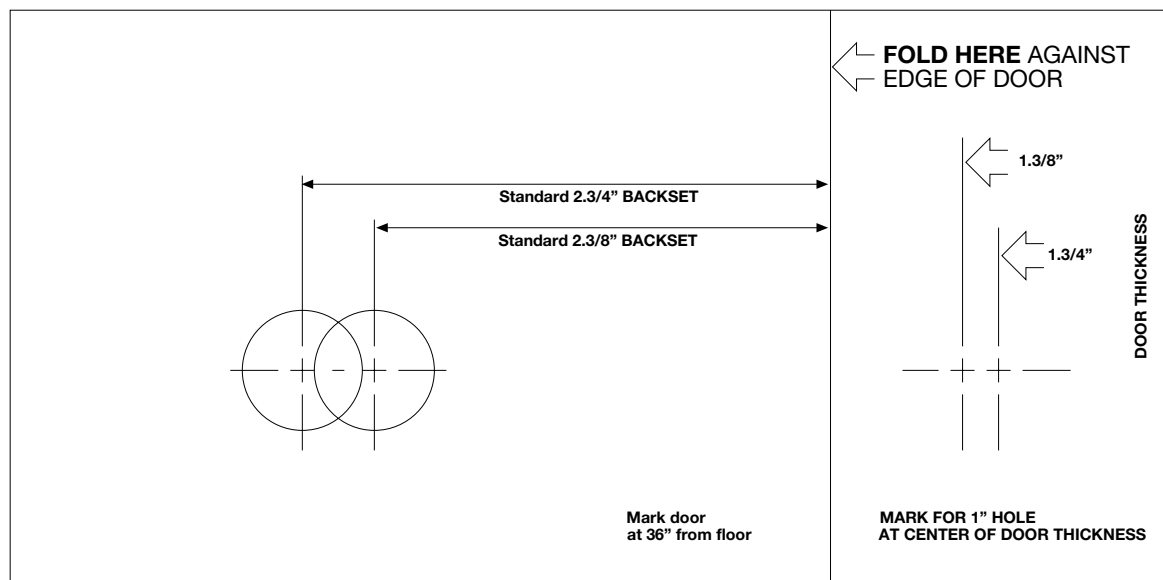

# ML F Entry Template Lever x Lever

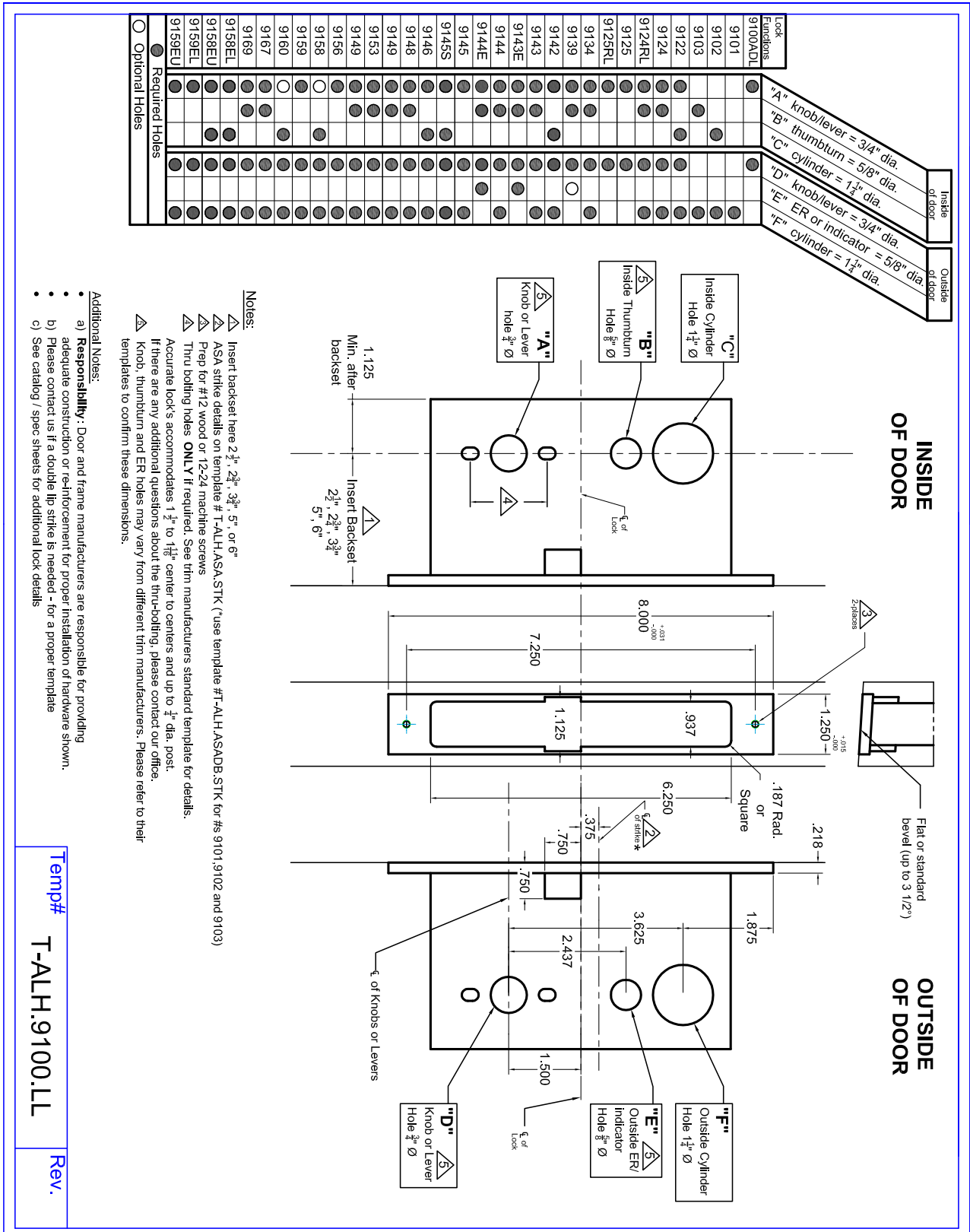

Lock Euronorms	Inside of door	Outside of door
9100ADL	●	●
9101	●	●
9102	●	●
9103	●	●
9122	●	●
9124	●	●
9124RL	●	●
9125	●	●
9125RL	●	●
9134	●	●
9139	●	●
9142	●	●
9143	●	●
9143E	●	●
9144	●	●
9144E	●	●
9145	●	●
9145S	●	●
9146	●	●
9148	●	●
9149	●	●
9153	●	●
9149	●	●
9156	●	●
9158	●	●
9159	●	●
9160	○	○
9167	●	●
9169	●	●
9158EL	●	●
9158EU	●	●
9159EL	●	●
9159EU	●	●
Optional Holes	○	○

Temp# T-ALH.9100.LL Rev.

# ML F TP Entry Template Handleset

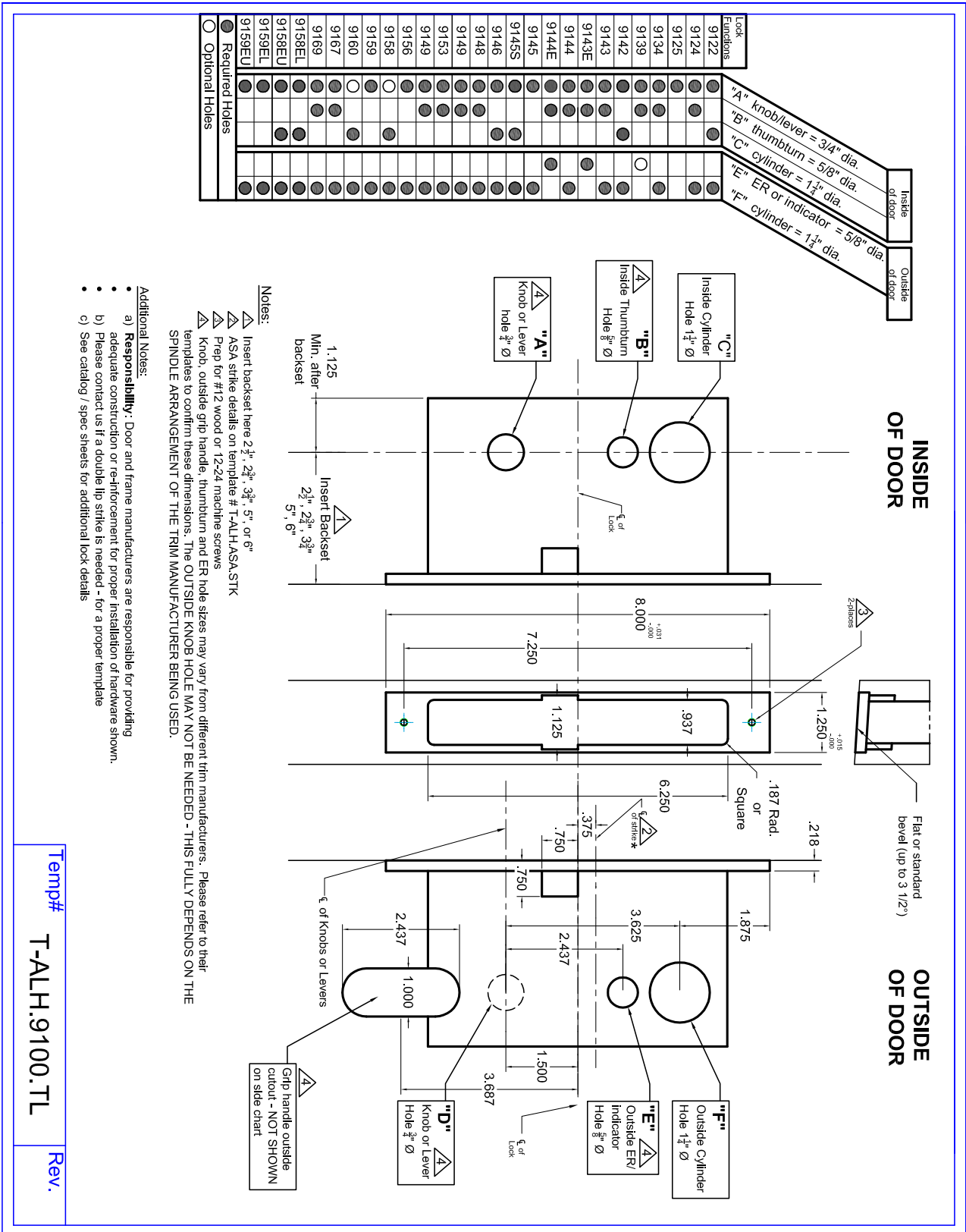

- Notes:**
- △ Insert backset here 2 1/2", 2 3/4", 3 3/4", 5", or 6"
  - △ ASA strike details on template # T-ALH.ASA.STK
  - △ Prep for #12 wood or 12-24 machine screws
  - △ Knob, outside grip handle, thumbturn and ER hole sizes may vary from different trim manufacturers. Please refer to their templates to confirm these dimensions. The OUTSIDE KNOB HOLE MAY NOT BE NEEDED - THIS FULLY DEPENDS ON THE SPINDLE ARRANGEMENT OF THE TRIM MANUFACTURER BEING USED.
- Additional Notes:**
- a) **Responsibility:** Door and frame manufacturers are responsible for providing adequate construction or re-inforcement for proper installation of hardware shown.
  - b) Please contact us if a double lip strike is needed - for a proper template
  - c) See catalog / spec sheets for additional lock details

Temp# **T-ALH.9100.TL** Rev.

# Dead Lock Template

## 7200 Series

### Auxiliary Dead Lock Installation Template

Note: All Dimensions Reflect Suggested Mortise Prep Dimensions.  
(Actual Lock Dimensions Are Slightly Smaller).

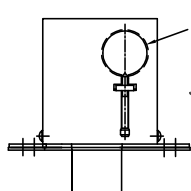
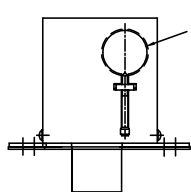
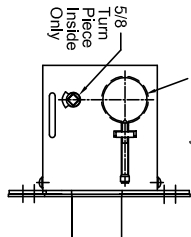
7201	7202	7203
 <p>1 1/4 Cylinder Outside Only</p>	 <p>1 1/4 Cylinder Both Sides</p>	 <p>1 1/4 Cylinder Outside Only 5/8 Turn Piece Inside Only</p>

Find Catalog Numbers Which Will Show Cutouts For Functions Desired. Refer To Composite Template Above For Locations And Sizes Of Holes.

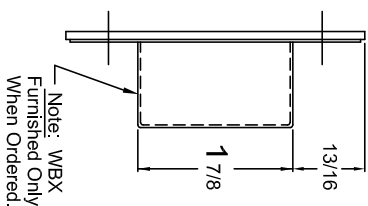
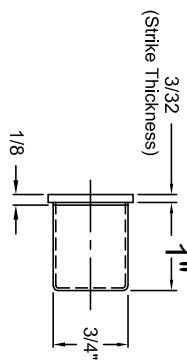
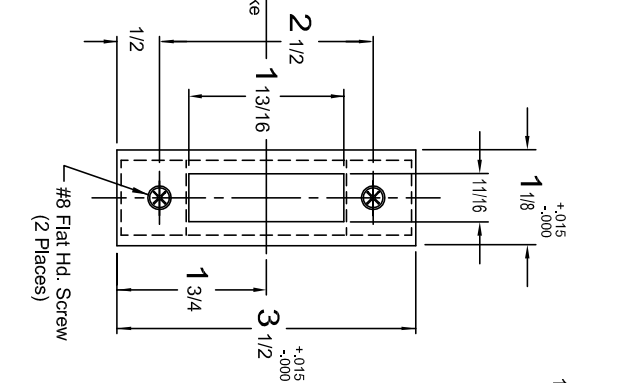
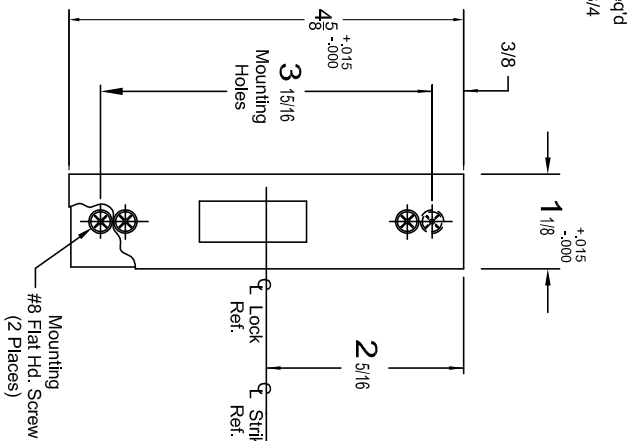
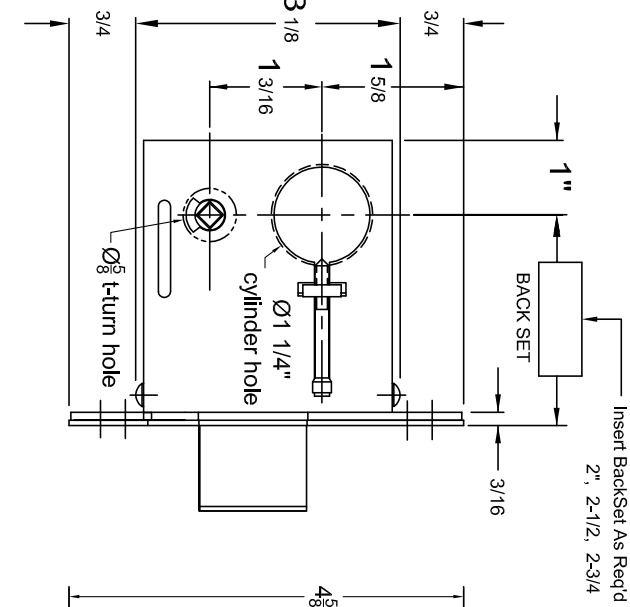
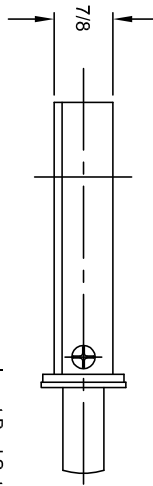

**Responsibility**  
Door And Frame Manufacturers Are Responsible For Providing Adequate Construction Or Re-Inforcement For Proper Installation Of Hardware Shown.

# Template PGE Pocket Pull

See Valli&Valli catalog - page 105

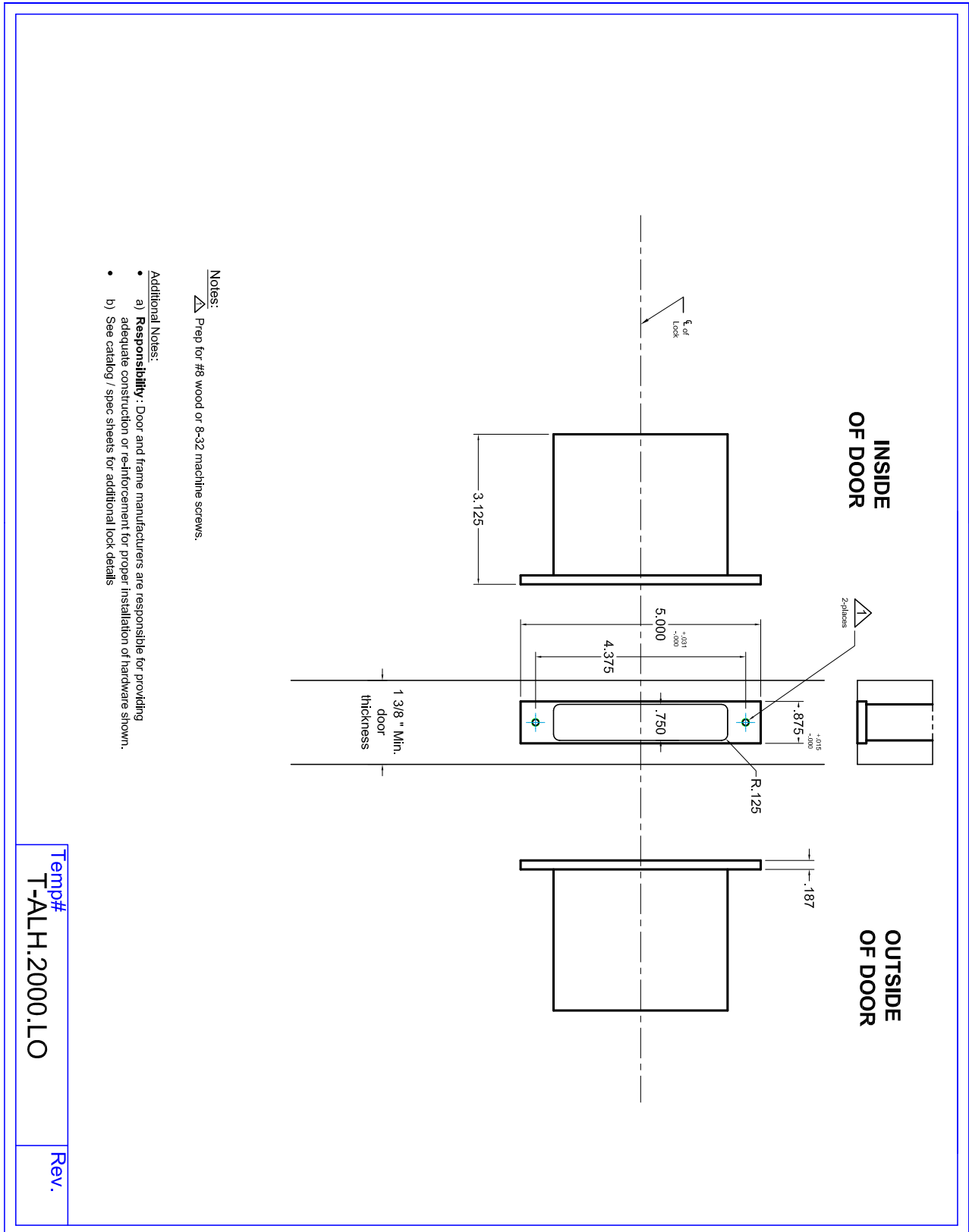

# Template PCY Pocket Door Lock

See Valli&Valli catalog - page 105

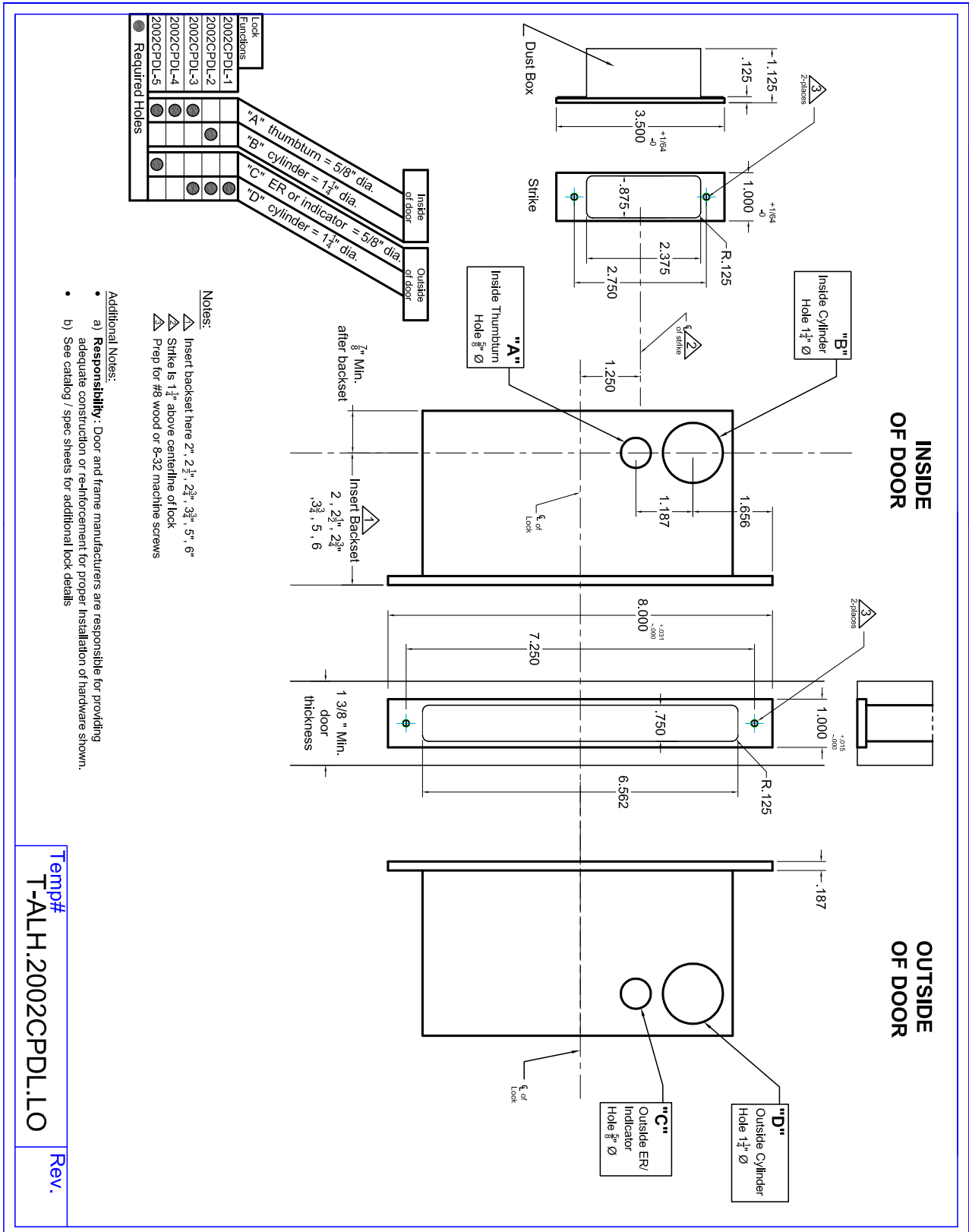

# Template ASA Strike

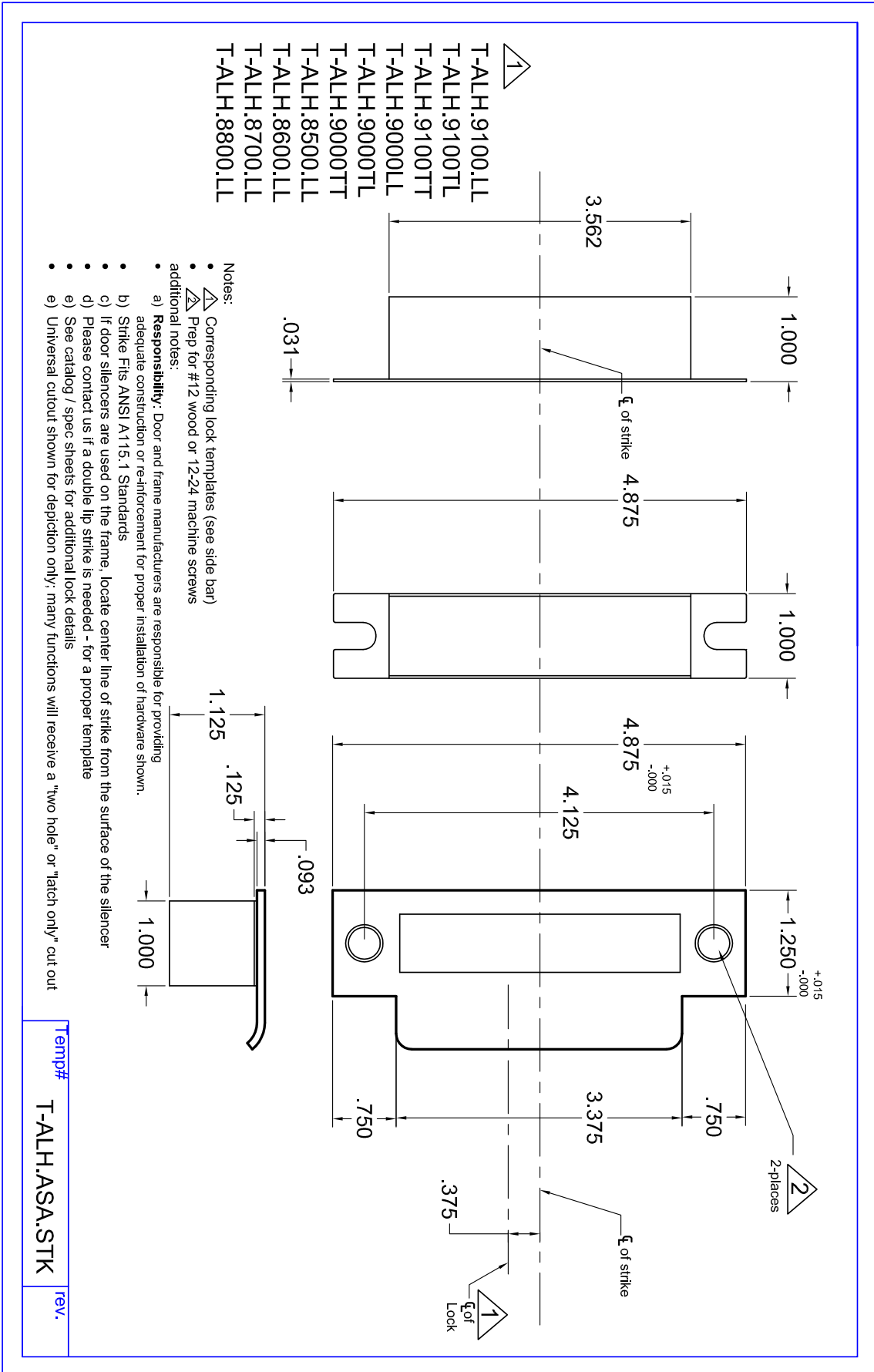

- T-ALH.9100.LL
- T-ALH.9100.TL
- T-ALH.9100.TT
- T-ALH.9000.LL
- T-ALH.9000.TL
- T-ALH.9000.TT
- T-ALH.8500.LL
- T-ALH.8600.LL
- T-ALH.8700.LL
- T-ALH.8800.LL

- Notes:
- Corresponding lock templates (see side bar)
  - Prep for #12 wood or 12-24 machine screws
  - **Responsibility:** Door and frame manufacturers are responsible for providing adequate construction or re-inforcement for proper installation of hardware shown.
  - additional notes:
    - a) **Responsibility:** Door and frame manufacturers are responsible for providing adequate construction or re-inforcement for proper installation of hardware shown.
    - b) Strike fits ANSI A115.1 Standards
    - c) If door silencers are used on the frame, locate center line of strike from the surface of the silencer
    - d) Please contact us if a double lip strike is needed - for a proper template
    - e) See catalog / spec sheets for additional lock details
    - e) Universal cutout shown for depiction only; many functions will receive a "two hole" or "latch only" cut out





# List of door thickness

# List of door thickness for each door lever

## DOOR HANDLES

Article	Series	Thickness from	to	1 3/4with spindle	1 3/8 with spindle
H 37	Tre B	33 mm	55 mm	8 x 114 mm	
H 310	Cinque C	33 mm	40 mm	8 x 114 mm	
H 311	Sei MB	30 mm	60 mm	8 x 114 mm	
H 315	G Novanta	33 mm	55 mm	8 x 114 mm	
H 317	AC Novantuno	33 mm	55 mm	8 x 114 mm	
H 326	AC 1 Novantacinque	33 mm	55 mm	8 x 114 mm	
H 327	AC 2 Novantacinque	33 mm	55 mm	8 x 114 mm	
H 329	RB Novantacinque	33 mm	55 mm	8 x 114 mm	
H 330	T Novantasette	33 mm	55 mm	8 x 114 mm	
H 332	M Novantotto	33 mm	55 mm	8 x 114 mm	
H 334	NF Novantotto	33 mm	55 mm	8 x 114 mm	
H 335	RM Novantotto	33 mm	43 mm	8 x 104 mm	8 x 96 mm
H 338	YK Duemila	33 mm	55 mm	8 x 114 mm	
H 341	HK2 Duemila	33 mm	55 mm	8 x 114 mm	
H 343	JP Duemila	40 mm	52 mm	8 x 104 mm	
H 344	JN Duemilauno	33 mm	50 mm	8 x 104 mm	
H 348	DC Duemiladue	33 mm	55 mm	8 x 114 mm	
H 350	CA Duemiladue	33 mm	55 mm	8 x 114 mm	
H 352	ODBC Duemiladue	32 mm	56 mm	8 x 114 mm	
H 354	FOG Duemilaquattro	40 mm	55 mm	8 x 104 mm	8 x 96 mm
H 356	ZH Duemilacinque	33 mm	55 mm	8 x 104 mm	
H 359	SOM NY Duemilasette	30 mm	60 mm	8 x 114 mm	
H 361	AC4 Duemilasei	40 mm	60 mm	8 x 114 mm	
H 362	CC Duemilauno	33 mm	60 mm	8 x 114 mm	
H 363	DC Duemila	33 mm	60 mm	8 x 114 mm	
H 364	MB Duemilanove	33 mm	60 mm	8 x 114 mm	
H 367	GV Duemilanove	33 mm	60 mm	8 x 114 mm	
H 368	CA Duemilanove	33 mm	60 mm	8 x 114 mm	
H 369	EG Duemilanove	33 mm	55 mm	8 x 104 mm	
H 370	MDF Duemiladieci	30 mm	55 mm	8 x 114 mm	
H 371	LK Duemilaundici	30 mm	55 mm	8 x 114 mm	
H 372	EG Duemilaundici	38 mm	48 mm	8 x 104 mm	
H 373	DOB Duemiladodici	40 mm	60 mm	8 x 114 mm	
H 375	Bassorilievo	40 mm	60 mm	8 x 114 mm	8 x 104 mm
H 376	Mercurio	40 mm	60 mm	8 x 114 mm	8 x 104 mm

UNI EN ISO

# Quality



www.icim.it

**CERTIFICATO n. 0689A/0**  
**CERTIFICATE No. \_\_\_\_\_**

SI CERTIFICA CHE IL SISTEMA DI GESTIONE AMBIENTALE DI  
 WE HEREBY CERTIFY THAT THE ENVIRONMENTAL MANAGEMENT SYSTEM OPERATED BY

**ASSA ABLOY Italia S.p.A.**

UNITA' OPERATIVE  
 OPERATIVE UNITS

**Sede e Unità Operativa**  
 Via Bovaresa, 13 - 40017 San Giovanni in Persiceto (BO)  
**Unità Operativa**  
 Via Concordia, 16 - 20838 Renate (MB)  
 Italia

E' CONFORME ALLA NORMA  
 IS IN COMPLIANCE WITH THE STANDARD

**UNI EN ISO 14001:2004**

PER LE SEGUENTI ATTIVITA'  
 FOR THE FOLLOWING ACTIVITIES

**EA: 17**

Progettazione e produzione di serrature meccaniche, elettriche ed elettroniche, chiavi, cilindri, lucchetti e chiudiporta mediante processi di produzione corpo chiudiporta, assemblaggio e confezionamento. Vendita di chiavi e cilindri. (Sito di San Giovanni in Persiceto).  
 Progettazione e produzione di maniglie e coordinati per l'arredamento mediante processi di: vibratura e brunitura a secco, decapaggio, brunitura, smerigliatura, sgrassaggio, lavaggio con detergenti, verniciatura, essiccazione, imballaggio e spedizione. (Sito di Renate)

*Design and production of: mechanical, electrical and electronic locks, keys, cylinders, padlocks and door closers, through processes of: production door closer body, assembly and packaging. Sale of Keystand cylinders (San Giovanni in Persiceto site).*  
*Design and production of handles and coordinates for the furnishings, through the processes of: tumbling dry, packing, burnishing, grinding, degreasing, washing with detergents, painting, drying, packaging and shipping (Renate site).*

Certificazione rilasciata in conformità al Regolamento Tecnico ACCREDIA RT-06  
 Il presente certificato è oggetto di rispetto del regolamento per la certificazione del rilascio e gestione ambientale delle attività.  
 The use and the validity of this certificate shall satisfy the requirements of the rules for the certification of company environmental management systems.

Data emissione First issue	Emissione corrente Current issue	Data di scadenza Expiring date
05/09/2014	05/09/2014	04/09/2017

  
**ICIM S.p.A.**  
 Piazza Ode Lucio Mapelli, 75 - 20899 Sesto San Giovanni (MI)



500 SP 001A ISO 9001:2008  
 720 SP 001B ISO 9001:2008  
 100 SP 001C ISO 9001:2008  
 100 SP 001D ISO 9001:2008  
 100 SP 001E ISO 9001:2008  
 100 SP 001F ISO 9001:2008  
 100 SP 001G ISO 9001:2008  
 100 SP 001H ISO 9001:2008  
 100 SP 001I ISO 9001:2008  
 100 SP 001J ISO 9001:2008  
 100 SP 001K ISO 9001:2008  
 100 SP 001L ISO 9001:2008  
 100 SP 001M ISO 9001:2008  
 100 SP 001N ISO 9001:2008  
 100 SP 001O ISO 9001:2008  
 100 SP 001P ISO 9001:2008  
 100 SP 001Q ISO 9001:2008  
 100 SP 001R ISO 9001:2008  
 100 SP 001S ISO 9001:2008  
 100 SP 001T ISO 9001:2008  
 100 SP 001U ISO 9001:2008  
 100 SP 001V ISO 9001:2008  
 100 SP 001W ISO 9001:2008  
 100 SP 001X ISO 9001:2008  
 100 SP 001Y ISO 9001:2008  
 100 SP 001Z ISO 9001:2008



www.cisq.com

Quality trade-marks/Marchi di qualità



**ICILA**  
**ISO 9001:2000**  
**Cert./ Zertifikat n. 77**  
**Institute for the Certification of Quality in the Wood and Decorative Industries**  
 Istituto per la Certificazione di Qualità delle Industrie del Legno e dell'Arredamento



**Italian Certification of Quality Systems**  
 Certificazione Italiana dei Sistemi di Qualità



**ISO 9001:2000**  
**Cert./ Zertifikat n. IT-2528**  
**International Quality Network**



**ACCESSIBLE**  
**All Valli & Valli USA inc Levers meet ADA accessibility requirements**

# Quality



www.icim.it

CERTIFICATO n. **0492/6**  
 CERTIFICATE No. \_\_\_\_\_

SI CERTIFICA CHE IL SISTEMA DI GESTIONE PER LA QUALITÀ DI  
 WE HEREBY CERTIFY THAT THE QUALITY MANAGEMENT SYSTEM OPERATED BY

**ASSA ABLOY Italia S.p.A.**

**Sede e Unità Operativa**  
 Via Bovaresa, 13 - 40017 San Giovanni in Persiceto (BO)  
**Unità Operative**  
 Via Concordia, 16 - 20838 Renate (MB)  
 Via Salvatore Quasimodo, 136 - 00144 Roma (RM)  
 Via S. Pio X, 52/A - 31020 San Vendemiano (TV)  
 Blocco 9.3 - Interporto - 40010 Bologna (BO)  
 Italia

E' CONFORME ALLA NORMA  
 IS IN COMPLIANCE WITH THE STANDARD

**UNI EN ISO 9001:2008**  
 PER LE SEGUENTI ATTIVITÀ  
 FOR THE FOLLOWING ACTIVITIES

**EA: 17 - 23e**

Progettazione, produzione, vendita e commercializzazione di serrature meccaniche, elettriche ed elettroniche; chiavi, cilindri, lucchetti, maniglioni antipanico e chiudiporta. Progettazione e produzione di maniglie e coordinati per l'arredamento.  
*Design, production, sale and trading of: mechanical, electrical and electronic locks; keys, cylinders, locks, panic exit devices and door closers.*  
*Design and manufacturing of handles and sets for furnishings*

Riferirsi al Manuale della Qualità per l'applicabilità dei requisiti della norma di riferimento.  
 Refer to Quality Manual for details of application to reference standard requirements.

Il presente certificato è soggetto al rispetto del regolamento per la certificazione dei sistemi di gestione per la qualità delle aziende.  
 The use and the validity of this certificate shall satisfy the requirements of the rules for the certification of company quality management systems.

Data emissione First issue 25/03/1996	Emissione corrente Current issue 06/03/2014	Data di scadenza Expiring date 05/03/2017
---	---	---

  
**ICIM S.p.A.**  
 Piazza Don Enrico Magelli, 75 - 20090 Sesto San Giovanni (MI)



ICIM S.p.A. è un ente di certificazione riconosciuto dal Ministero delle Attività Produttive e iscritto nel Registro degli Enti di Certificazione del Ministero delle Attività Produttive.  
 ICIM S.p.A. is a certification body recognized by the Ministry of Economic Development and registered in the Register of Certification Bodies of the Ministry of Economic Development.



CISQ è la Federazione Italiana di Organismi di Certificazione dei sistemi di gestione aziendale.  
 CISQ is the Italian Federation of management system Certification Bodies.

## Quality trade-marks/Marchi di qualità



**ICILA**

ISO 9001:2000  
 Cert./ Zertifikat n. 77

**Institute for the Certification of Quality in the Wood and Decorative Industries**

Istituto per la Certificazione di Qualità delle Industrie del Legno e dell'Arredamento



**Italian Certification of Quality Systems**

Certificazione Italiana dei Sistemi di Qualità



**ISO 9001:2000  
 Cert./ Zertifikat n.  
 IT-2528 International Quality Network**



**All Valli & Valli USA inc  
 Levers meet ADA  
 accessibility requirements**

# General sales terms and conditions

# General sales terms and conditions

All orders are accepted subject to the following Terms and Conditions of Sale. Any terms and/or conditions contained in the Buyer's purchase order or other writing pertaining to such order which are in conflict with or add to or subtract from the following Terms and Conditions of Sale shall not become part of any resulting contract unless expressly accepted in writing by Valli & Valli (U.S.A.) Inc. ("V&V").

## 1. GENERAL INFORMATION

- (a) V&V reserves the right to accept or reject any order for any reason.
- (b) No order is binding on V&V until received in writing and approved by V&V. V&V agrees to sell and Buyer agrees to buy only in accordance with these terms and conditions which are applicable to and binding upon the sale and purchase of every product sold by V&V. No departure from these terms and conditions in any respect whatsoever shall be valid except when in writing and signed by an authorized officer of V&V. Any additions, deletions or other changes to or in an order are subject to the terms and conditions stated herein. No salesman or agent of V&V has the authority to make any changes in V&V's terms and conditions or sale prices.
- (c) V&V shall deliver the products specified on an order within a reasonable time after acceptance of orders, and shall use reasonable efforts to make timely delivery subject to the ability of V&V to ship, at the time and in the quantity specified, contingent upon strikes, floods, fires, accidents, labor or material troubles, product availability, or rules and regulations of the United States or any State, municipal or other lawful authority therein or where V&V's products are manufactured, or other causes beyond the control of V&V, and V&V shall not be liable for damages for failure to make partial or complete shipment or for any delay in making shipments. In no event shall the terms of this provision affect Buyer's obligation to pay for goods sold and delivered.
- (d) The Buyer may not cancel an order without V&V's consent. If V&V is unable to make shipment of specified quantities of its standard products within thirty (30) days of the specified time and so notifies the Buyer, the Buyer may give notice to V&V by telefax confirmed by letter sent registered mail of its intention to cancel that part of the order which remains unshipped at the time of V&V's receipt of such telefax or within fifteen (15) days after the post-marked date of such letter, whereupon such unshipped part of the order shall be cancelled.
- (e) All specifications listed in our Catalog and/or Price List are subject to change without notice including packing, weights, measurements and product designs.

## 2. PRICES

- (a) Prices are quoted, products are sold, and all shipments are made F.O.B. V&V's warehouse, unless otherwise specified. All prices are stated in U.S. currency.
- (b) Each order, or any part thereof, is subject to billing and payment at V&V's prices in effect at the time of shipment.
- (c) V&V reserves the right to change any of the prices of an order up to the date of shipment, upon notice to the Buyer. Any orders upon which prices have been changed which are not confirmed by Buyer within fifteen (15) days of notice being sent shall be cancelled.
- (d) All prices are subject to additional federal, city and state taxes, if applicable.
- (e) Prices, terms and conditions of sale, and trade discounts, if any, are subject to change without prior notice at any time prior to V&V's acceptance of the Buyer's order.

## 3. TERMS OF PAYMENT

- (a) Terms of payment are thirty (30) days net from the date of V&V's invoice and payment is not timely unless actually received by V&V on or before the due date.
- (b) A service and carrying charge of one and one half (1-1/2%) percent per month (annual percentage rate eighteen (18%) percent) will be charged on all invoices outstanding more than thirty-five (35) days. Buyer shall pay all costs and expenses (including reasonable attorney's fees) incurred by V&V in connection with any payments not made when due. V&V reserves the right to stop confirmed shipments to accounts which have invoices over sixty (60) days past due.
- (c) If Buyer fails to pay an invoice at maturity or defaults on or repudiates this or any other agreement with V&V, or becomes insolvent or calls a meeting of its creditors or if a bankruptcy, insolvency, re-organization or arrangement proceeding is commenced by or against Buyer, V&V may (i) cancel this and/or any other contracts with Buyer, and Buyer shall remain liable for any damages to V&V; or (ii) (a) declare all outstanding invoices under this and/or any other contracts immediately due and payable; (b) defer any shipments hereunder; (c) sell all or part of the undelivered goods at private or public sale, at which V&V may become buyer; (d) bill at contract price all or any part of the undelivered goods to Buyer, with delivery to Buyer only after full payment is made; and (e) take possession of delivered but unpaid for goods wherever found without process of law.
- (d) If, at any time, reasonable grounds for insecurity arise with respect to Buyer's performance of its payment obligations to V&V. V&V may demand payment in full for the products or such financial security which in V&V's sole discretion shall be equivalent to the sales price of the products.

## 4. RUSH DELIVERY CHARGES \$ 25.00 NET

Applies to all orders requested to be shipped within 48 hrs.

## DROP SHIP CHARGES \$ 5.00

## 5. SHIPPING AND FREIGHT ALLOWANCE

V&V will ship products in any manner most satisfactory to V&V, based upon convenience, experience and cost. Full freight allowed and prepaid to all points in the continental United States on any shipment equal to or in excess of One Thousand (\$1,000.00) Dollars net invoice value by the carrier of V&V's selection.

No freight allowance on shipments of less than One Thousand (\$1,000.00) Dollars net invoice value. A One (\$1.50) Dollar fifty cent service charge per shipment shall be applied for freight handling and insurance coverage.

## 6. RETURNS

A written request must be received by V&V and approved by an authorized officer of V&V in writing prior to the return of any products. Any approved returns shall be delivered at Buyers expense freight prepaid to any point designated by V&V and a minimum of thirty-five (35%) percent handling charge will apply. A handling fee will be charged on all returned goods. All returned goods must be returned in the original factory sealed cartons and must be in saleable condition. Merchandise may be returned for credit toward future orders only. Credit must be applied within one (1) year of the date of issuance.

## 7. CLAIMS

Risks of theft, loss or damage to, or destruction of, the products shall pass to the Buyer when the products are placed in the possession of the first carrier at V&V's place of shipment. Claims for damage, loss in transit and delay in delivery must be made to the carrier by the Buyer. All other claims must be reported promptly within fifteen (15) days of receipt of merchandise. Replacement deliveries shall be made or returns accepted only if V&V's investigation supports the claim. V&V's liability with respect to substantiated claims shall be limited to either replacing or accepting the return of the products with refund of the original purchase price.

## 8. LIMITED WARRANTY

V&V warrants to third party purchasers that V&V products shall be free from defects in material or workmanship for a period of one (1) year following their purchase from an authorized V&V dealer. V&V's sole obligation under this warranty shall be to repair or replace products which V&V determines to be defective and which are returned to V&V with proper documentation during the warranty period, shipping charges prepaid to 100 Commerce Way, Suite 2, Hackensack, NJ 07601.

V&V DOES NOT ASSUME ANY WARRANTY RESPONSIBILITY FOR DAMAGES DUE TO CONDITIONS OVER WHICH V&V HAS NO CONTROL, INCLUDING BUT NOT LIMITED TO IMPROPER INSTALLATION, IMPACT, TAMPERING OR ABUSE. FINISHES CANNOT BE GUARANTEED FROM TARNISHING, EXCESSIVE WEAR, OR DETERIORATION DUE TO EXPOSURE TO ATMOSPHERIC CONDITIONS OVER WHICH V&V HAS NO CONTROL. V&V MAKES NO OTHER WARRANTIES, EXPRESS OR IMPLIED, WITH RESPECT TO THE PRODUCTS DELIVERED, INCLUDING WITHOUT LIMITATION, ANY WARRANTY OF MERCHANTABILITY OR FITNESS FOR A PARTICULAR PURPOSE. IN NO EVENT SHALL V&V BE LIABLE FOR ANY SPECIAL, INDIRECT, INCIDENTAL OR CONSEQUENTIAL DAMAGES INCLUDING, BUT NOT LIMITED TO, LOSS OF PROFITS OR DAMAGES TO BUSINESS OR BUSINESS RELATIONS.

THIS WARRANTY IS IN LIEU OF ALL OTHER WARRANTIES EXPRESS OR IMPLIED, STATUTORY OR OTHERWISE AND IS LIMITED TO THE DURATION OF THE WARRANTY PERIOD OF THIS EXPRESS WARRANTY. SOME STATES DO NOT ALLOW LIMITATION ON HOW LONG AN IMPLIED WARRANTY LASTS OR THE EXCLUSION OR LIMITATION OF INCIDENTAL OR CONSEQUENTIAL DAMAGES SO THE ABOVE LIMITATIONS OR EXCLUSIONS MAY NOT APPLY TO BUYER. THIS WARRANTY GIVES YOU SPECIFIC LEGAL RIGHTS AND BUYER MAY ALSO HAVE OTHER RIGHTS WHICH VARY FROM STATE TO STATE.

## 9. GOVERNING LAWS

Any controversy or claim arising out of or relating to the purchase or sale of V&V's products shall be construed in accordance with the laws of the State of New York and shall be settled by arbitration in the City, Country and State of New York in accordance with the current Commercial Arbitration Rules of the American Arbitration Association and judgment upon the award rendered may be entered in any court of competent jurisdiction.

## 10. SIZES AND DIMENSIONS

Conversion from metric to U.S. measurements is approximate. Refer to product for exact metric sizing.

## 11. PROJECTS

All project orders require a down payment. **Freight: FOB New Jersey warehouse**

## 12. DISCONTINUED

We can discontinue products or alter specifications at any time without prior notification or obligation. Product will continue to be available as long as inventory remains, after which the product will be discontinued. This program is intended to help our customers anticipate future needs and to avoid bidding or taking orders on parts which may not be available in sufficient quantities when needed.

## 13. INDUSTRY STANDARD

The prevailing industry standard is that the special order items, electrical products and specialty keyed products may not be returned.

## 14. INSTRUCTIONS

Door handles and their accessories are designed to open and close doors. They represent a complimentary element of the door, together with the frame, hinges, door panel, lock and cylinder.

Opening and closing a door with a handle requires certain actions, such as opening a security bolt.

Only in certain cases, such as on emergency doors, the handles serves the function of working the lock by lowering or pushing it.

Window handles too are to be considered only a complimentary part of the window. It is normally the opening system of the window that determines the hardware required and consequently the mechanism required for the working of the window handle.

Door handles, pull handles and window handles are often incorrectly used, damaging the product and the quality standard defined by the manufacturer.

Common errors include:

The use of the handle as a support or hook for objects which may be excessively heavy.

The use of the handle as a plaything by children.

The use of the handle as a doorstop against the wall.

Fusital products do not require excessive maintenance. For care and cleaning, except in those cases where a specific product is recommended for certain finishes, Fusital recommends the use of just a soft dry cloth.

To ensure correct installation, the instructions contained in the box should be followed.

If necessary consult the retailer or specialized personnel.

In the case of products in glass or porcelain together with brass, it should be remembered that these fragile materials are liable to break if used incorrectly.

Fusital recommends the use of doorstops fixed to the floor or the wall close to the door or its handle.

On all products with a grab screw Fusital recommends the use of a retaining compound.

It is also advisable to check the position and tightness of all fixing elements at regular intervals.

The user/purchaser of the product should ask the retailer for instructions regarding the correct installation, care and maintenance of the product.

Fusital products are subject to a continual process of development and updating, and production is constantly monitored by Valli&Valli Quality Assurance.

Most Fusital products are "tools" for opening and closing doors and windows.

Inevitably, as with all artifacts, depending on the material of which they are made and where they are made and where they are used, they are subject to wear and then passing of time.

Brass, an alloy subject to oxidation, has to be covered with a protective coating if its appearance is to remain unchanged over time.

Care should be taken during use and maintenance, as improper use or poor maintenance could damage the protective coating, permitting corrosion and consequently causing an anti-aesthetic appearance.

Stainless steel is generally considered to be indestructible.

However, even this material can show the occasional scratch or spot of rust.

Such rust-spots are so-called "surface ruse", and can be removed using an appropriate cleaner, available from specialized retailers.

The manufacturer cannot be held responsible for damage due to normal wear and tear, incorrect treatment, installation or maintenance or non-observance of the above warnings.





Headquarter/Showroom  
Valli&Valli (U.S.A.) Inc.  
22 West 21st Street  
6th Floor  
New York, NY 10010  
Tel. (212) 326 8811  
Fax (212) 326 8816  
Toll Free (877) 326 2565  
Toll Free (800) 423 7161  
E-mail: sales@vallivalli-us.com  
E-mail: w.sales@vallivalli-us.com

Warehouse  
Valli&Valli (U.S.A.) Inc.  
100 Commerce Way, Suite 2  
Hackensack, NJ 07601  
Tel. (973) 249 0085  
Fax (973) 249 0135

Italian commercial office  
Ufficio commerciale Italia

Tel. +39 0362 982271  
Fax +39 0362 982235  
vallitalia@assaabloy.it

Export office/Ufficio Export

Tel. +39 0362 982260  
Fax +39 0362 982214  
vall.export@assaabloy.it

Showroom  
New York  
22 West 21st Street  
6th Floor  
New York, NY 10010  
Tel. (212) 326 8811  
Fax (212) 326 8816

Factory/Stabilimento

20838 Renate (MB) Italy  
Via Concordia, 16

[www.vallivalli-us.com](http://www.vallivalli-us.com)  
[www.assaabloy.com](http://www.assaabloy.com)



[www.vallivalli-us.com](http://www.vallivalli-us.com)

**Valli&Valli (U.S.A.) Inc.**

**Headquarter/Showroom**

Valli&Valli (U.S.A.) Inc.  
22 West 21st Street  
6th Floor  
New York, NY 10010  
Tel. (212) 326 8811  
Fax (212) 326 8816  
Toll Free (877) 326 2565  
Toll Free (800) 423 7161  
E-mail: [sales@vallivalli-us.com](mailto:sales@vallivalli-us.com)  
E-mail: [w.sales@vallivalli-us.com](mailto:w.sales@vallivalli-us.com)

**Warehouse**

Valli&Valli (U.S.A.) Inc.  
100 Commerce Way, Suite 2  
Hackensack, NJ 07601  
Tel. (973) 249 0085  
Fax (973) 249 0135



[www.vallievalli.com](http://www.vallievalli.com)  
[www.assaabloy.com](http://www.assaabloy.com)

ASSA ABLOY is the global leader in door opening solutions, dedicated to satisfying end-user needs for security, safety and convenience.

RIF. 2011 01/15