

FALCON®

Locks

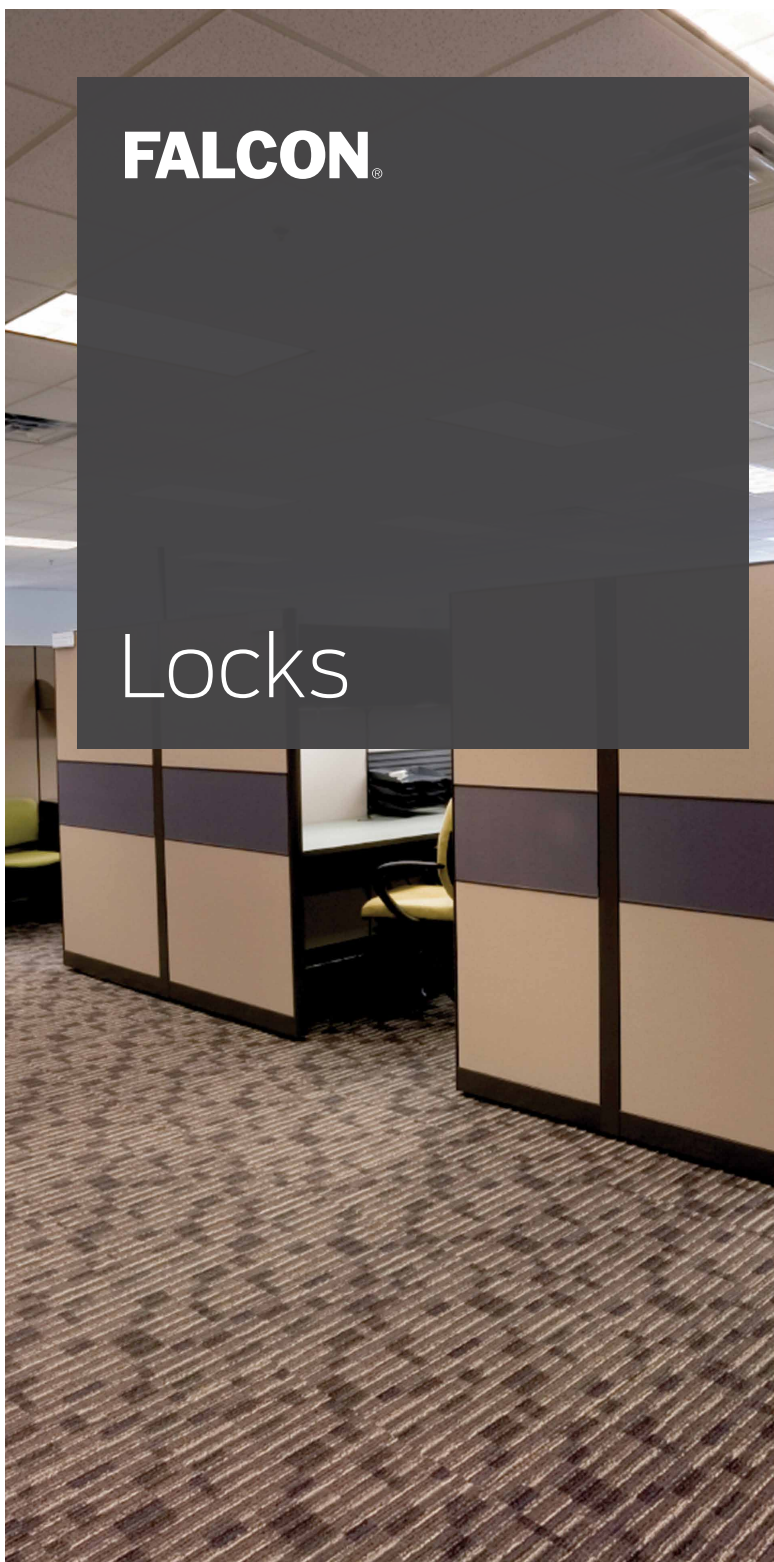

Contents

4-16	RU/RW Series
18-29	T Series
30-41	X Series
42-51	B Series
52-63	W Series
64-76	Auxiliary locks
78-93	MA Series



The Falcon difference

Safety, security and uncompromising value

At Falcon, we know that every product you sell not only has to meet local building codes, but also your expectations for performance and quality. We take your expectations seriously, and that's why we build our locks to deliver durability, convenience and unmatched value. After all, we've built our reputation on the same standards that you have – providing quality products at a reasonable price delivered on time. It's the way we do business and it's what makes Falcon locks a powerful choice no matter what your project.

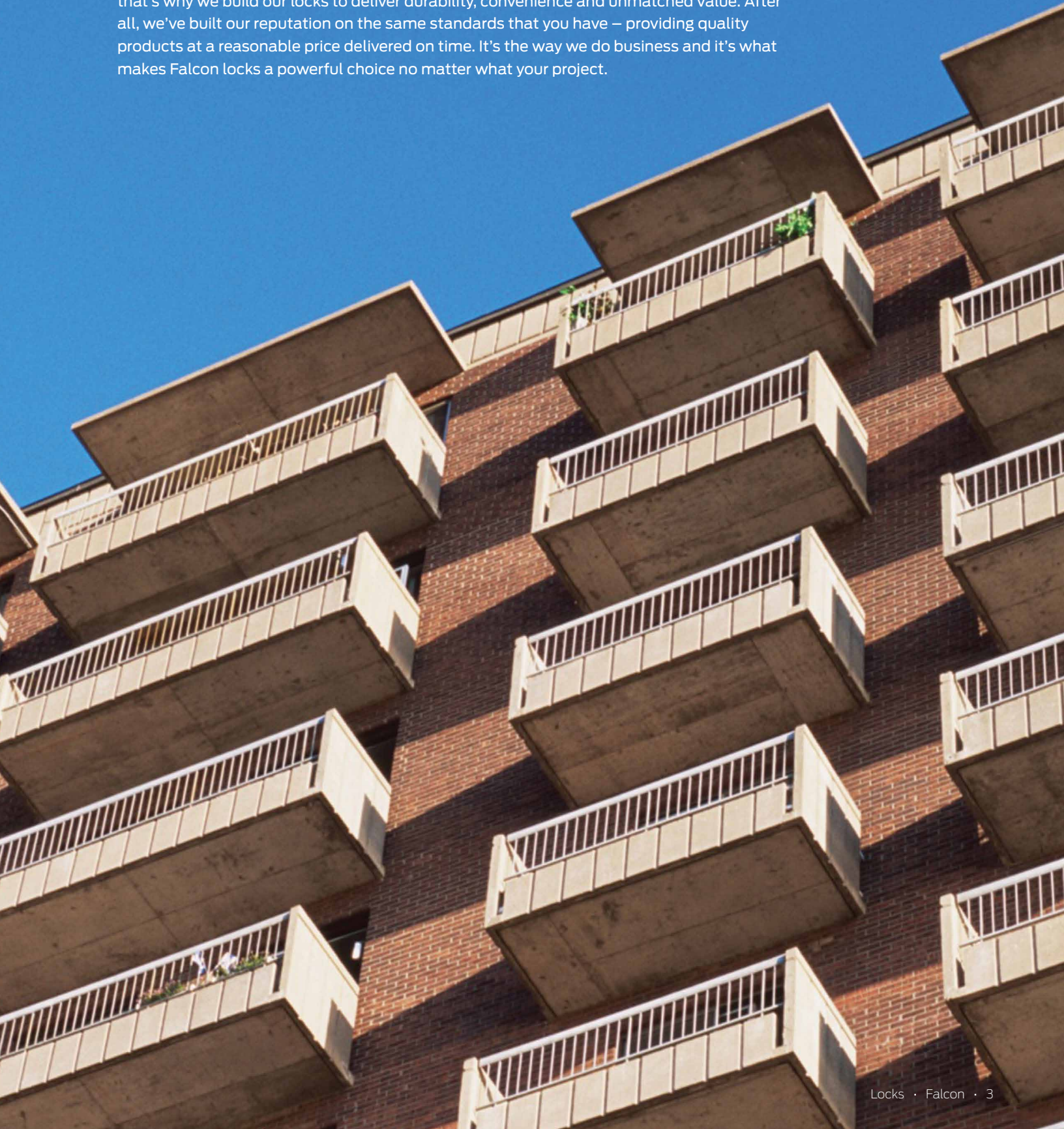

RU/RW Series

Extra heavy-duty preassembled unit locks

When you need to replace an existing notched-style lock and get up to code on ADA accessibility the Falcon RU/RW Series is a perfect fit. Designed specifically for retrofitting older and historical buildings, this unique lock combines old-fashioned styling with modern strength, security and convenience. Falcon RU/RW Series locks have an interchangeable core that can be removed for quick, easy re-keying. Our interchangeable cores are compatible with SFIC products from other manufacturers. And they're backed by one of the best names in the business.

Features

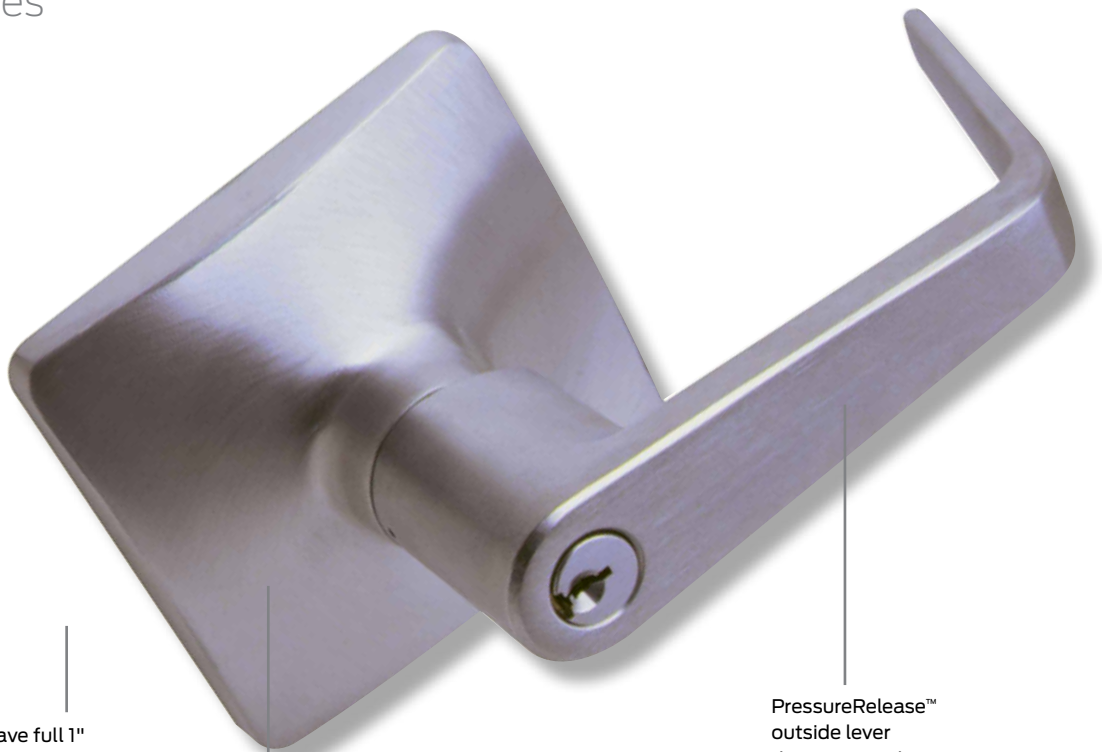

Deadlocks have full 1" latches standard

Trim is solid, bar stock brass

PressureRelease™ outside lever disengages when locked to protect internal mechanisms

Retrofit locks

The RU Series from Falcon is designed to retrofit existing unit locks manufactured by Falcon (Weiser), Corbin Russwin and Yale. It exceeds ANSI Grade 1 specifications and is UL/ULC listed. Incorporates Falcon's vandal resistant PressureRelease™ trim to prevent damage to internal mechanism. Installs with minimal rework to existing doors while preserving door and frame for cost effective project planning. Falcon's RU Series satisfies all ADA easy access requirements.

Features and benefits

Features include:

- Vandal resistant PressureRelease™ outside lever disengages when locked to prevent damage to internal mechanism.
- 3 lever designs.
- Complements Falcon's "family" of lever designs.
- "Power Spring™" in rose trim prevents lever sag.
- 12 commercial lock functions.
- 6 standard finishes: 605, 606, 612, 613, 625, 626.
- No exposed mounting screws.
- Solid bar stock deadlocking feature prevents latch binding and lock failure due to poor door alignment.
- Exceeds 800,000 cycle ANSI Grade 1 requirement.
- Meets or exceeds all other ANSI A156.2 rigorous Grade 1 specifications for key-in-lever products.

Benefits include:

- Preserves existing facility doors and frames.
- Preserves original architectural design without adapter plate or add-ons.
- Easy installation with minimal door modifications.
- Features a 4" square rose which covers existing mounting holes, most paint lines and required door rework.
- Complies with ADA easy access requirements.
- UL/ULC listed for 3 Hour A Label doors.
- Strikes available to match existing frame preparation.
- Reuse existing facility cylinders and key system.
- Non-handed chassis and field reversible trim and latch bolt for easy stocking and lower inventory cost.
- Key removable outside lever for easy cylinder replacement.
- Outside lever secured by a spring-loaded retainer. Retainer cannot be depressed when locks have been locked. Inside lever secured by a set screw. Levers have heavy-duty steel individual return springs in order to prevent lever sag.

RU Series specifications

Retrofit locksets shall be Falcon lock RU Series or equal and meet the following requirements:

- Exceeds ANSI A156.2 Grade1 key-in-lever specifications.
- Available with Falcon standard or interchangeable core cylinders in 6 and 7-pin configuration.
- Interchangeable core levers are non-removable with core installed.
- Available with some 6-pin competitor's keyways.
- Accepts interchangeable (removable) cores and standard 6-pin cylinders from the following manufacturers: Arrow, Assa, Best, Corbin Russwin (except Master-Ring), Medeco, Sargent, Schlage and Yale.
- PressureRelease™ (clutchable) outside lever.
- Heavy duty, solid levers are 5" long and have no inserts.
- No exposed mounting screws.
- Installs with 10-32 through-bolt screws with thread sealant for extra security and resistance to vibrating loose.
- Standard lock is for 1 3/4" thick doors. Also available for 2" and 2 1/4" thick doors.
- 2 3/4" backset only.
- ANSI strike standard.
- Optional OEM strikes available.

Levers

Levers are solid pressure cast zinc, finished to match mating parts. Roses are wrought brass or bronze, and are installed over pressure cast through-bolted rose inserts. Levers are secured by a spring-loaded retainer. Retainer cannot be depressed when locks have been locked.

A
Avalon



A
Avalon



D
Dane



D
Dane

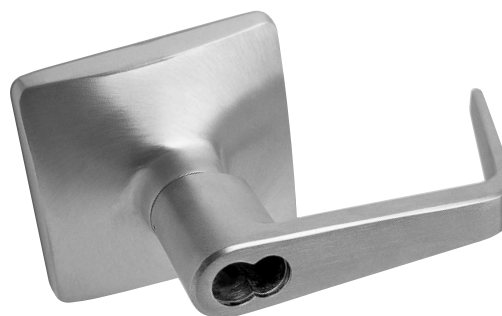

Q
Quantum













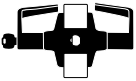











Q
Quantum



Functions

To order Falcon lock RU Series locksets, please consult page 12 for ordering information and assistance.

 Indicates interchangeable core available.

Catalog number	Function	Description
RU101		Passage/closet latchset—Latch bolt by levers at all times.
RU301		Privacy lock—Latch bolt by levers. Outside lever locked by push button in inside lever. Rotating inside lever or closing door releases push button. Emergency release in outside lever unlocks door.
RU381	 	Entry/restroom lock—Deadlocking latch bolt by levers except when outside lever is locked by key inside, then by key outside. Inside lever is always locked.
RU411	 	Asylum lock—Deadlocking latch bolt by key from either side at all times. Both levers inoperable.
RU501	 	Entry lock—Push button locking. Button on inside locks outside lever until unlocked by key or by rotating inside lever. Inside lever always free. Deadlocking latch bolt.
RU511	 	Entry/office lock—Turn/push button locking. Pushing and turning button locks outside lever requiring use of key until button is manually unlocked. Push button locking. Pushing button locks outside lever until unlocked by key or by rotating inside lever. Inside lever always free. Deadlocking latch bolt.
RU521	 	Office lock—Turn button locking. Turning button locks outside lever requiring use of key until button is manually unlocked. Inside lever always free. Deadlocking latch bolt.
RU561	 	Classroom lock—Deadlocking latch bolt by levers. Outside lever is locked by key in outside lever. Inside lever is always free.
RU571	 	Dormitory lock—Deadlocking latch bolt by levers except when locked by push button in inside lever. Key in outside lever locks or unlocks lever and releases button. Closing door releases push button. Inside lever always free.
RU581	 	Storeroom lock—Deadlocking latch bolt by lever inside or key outside. Outside lever is inoperable. Inside lever always free.
RU851	 	Storeroom (electrified-fail safe)—Latch bolt operated by lever from either side except when outer lever is electrically locked. When outer lever is locked (inoperable), latch bolt retracted by key in cylinder outside dead locking latch bolt. 24V/DC .185AMPS.
RU881	 	Storeroom (electrified-fail secure)—Deadlocking latch bolt operated by lever inside at all times. Outside lever inoperable until electrically unlocked, then latch bolt from either side. When outside lever is inoperable, latch bolt retracted by key in cylinder outside.

Interchangeable cores

The Falcon Lock RU Series accepts the following manufacturers' interchangeable cores:

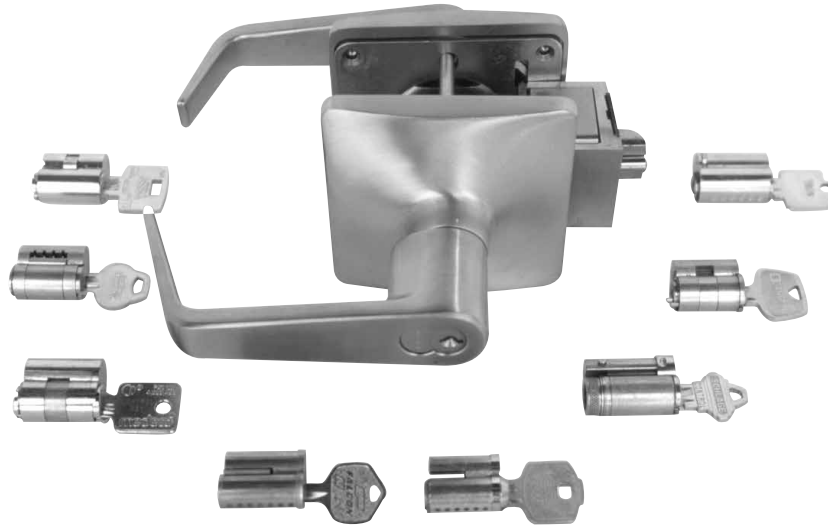

Interchangeable cores*

- Falcon
- Best
- Peaks (Kaba)
- Schlage
- Arrow
- Corbin Russwin
- Primus (Schlage)
- Yale - 32 Series
- Assa
- Sargent
- Medeco

*Locks must be modified for some cylinders. Be sure to specify manufacturer when ordering.

Interchangeable cores

Catalog number	Description
C606	For use in all RU Series I/C keyed locks – 6-pin (cover style)
C607	For use in all RU Series I/C keyed locks – 7-pin (cover style)
CB806	For use in all RU Series I/C keyed locks – 6-pin (cap style)
CB807	For use in all RU Series I/C keyed locks – 7-pin (cap style)

Note: Specify finish: 606 or 626. Specify keyway: "A" (standard or other keyway)

Standard cylinders

The Falcon Lock RU Series accepts the following manufacturers' 6-pin cylinders:



Standard 6-pin cylinders*

- Falcon
- Corbin Russwin
- Medeco
- Sargent
- Yale - Monolock - unit lock
- Arrow
- Peaks
- Schlage
- Assa
- Lori
- Primus (Schlage)
- Yale

*Locks must be modified for some cylinders. Be sure to specify manufacturer when ordering.

Standard cylinders

Catalog number	Description	Function
A23151-05	5-Pin assembly	All except 381 inside cylinder, 571
A23151-06	5-Pin assembly	All except 381 inside cylinder, 571
A23151-07	5-Pin assembly	All except 381 inside cylinder, 571
A23161-05	6-Pin assembly	All except 381 inside cylinder
A23161-06	6-Pin assembly	All except 381 inside cylinder
A23161-07	6-Pin assembly	All except 381 inside cylinder
A23171-05	7-Pin assembly	571
A23171-06	7-Pin assembly	571
A23171-07	7-Pin assembly	571

Note: Specify finish: 606 or 626. Specify keyway: "E", "G" (standard), "H", "K", "L", "N", "P".

Competitor keyways

Standard cylinders with competitor keyways - 6-pin

Catalog number	Description	Function
A23170-000	Arrow 'O' bitted	All except 381 IS, 571
A23170-OKA	Arrow 'KA' keyed alike 4	All except 381 IS, 571
A23170-OKD	Arrow 'KD' keyed different	All except 381 IS, 571
A23167-000	Corbin 60 'O' bitted	All except 381 IS, 571
A23167-OKD	Corbin 60 'KD' keyed different	All except 381 IS, 571
A23174-000	Corbin Russwin L4 'O' bitted	All except 381 IS, 571
A23168-000	Russwin D1 'O' bitted	All except 381 IS, 571
A23168-OKD	Russwin D1 'KD' keyed different	All except 381 IS, 571
A23166-000	Sargent LA 'O' bitted	All except 381 IS, 571
A23166-OKD	Sargent LA 'KD' keyed different	All except 381 IS, 571
A23160-000	Schlage C 'O' bitted	All except 381 IS, 571
A23160-OKA	Schlage C 'KA' keyed alike 4	All except 381 IS, 571
A23160-OKD	Schlage C 'KD' keyed different	All except 381 IS, 571
A23159-000	Schlage E 'O' bitted	All except 381 IS, 571
A23169-000	Yale 8 (Para) 'O' bitted	All except 381 IS, 571
A23169-OKD	Yale 8 (Para) 'KD' keyed different	All except 381 IS, 571
A23158-000	Yale GA 'O' bitted	All except 381 IS, 571
A23170-011	Arrow 'O' bitted	381 Inside cylinder
A23170-11A	Arrow 'KA' keyed alike 4	381 Inside cylinder
A23170-11D	Arrow 'KD' keyed different	381 Inside cylinder
A23167-011	Corbin 60 'O' bitted	381 Inside cylinder
A23167-11D	Corbin 60 'KD' keyed different	381 Inside cylinder
A23174-011	Corbin Russwin L4 'O' bitted	381 Inside cylinder
A23168-011	Russwin D1 'O' bitted	381 Inside cylinder
A23168-11D	Russwin D1 'KD' keyed different	381 Inside cylinder
A23166-011	Sargent LA 'O' bitted	381 Inside cylinder
A23166-11D	Sargent LA 'KD' keyed different	381 Inside cylinder
A23160-011	Schlage C 'O' bitted	381 Inside cylinder
A23160-11A	Schlage C 'KA' keyed alike 4	381 Inside cylinder
A23160-11D	Schlage C 'KD' keyed different	381 Inside cylinder
A23159-011	Schlage E 'O' bitted	381 Inside cylinder
A23169-011	Yale 8 (Para) 'O' bitted	381 Inside cylinder
A23169-11D	Yale 8 (Para) 'KD' keyed different	381 Inside cylinder
A23158-011	Yale GA 'O' bitted	381 Inside cylinder
A23170-012	Arrow 'O' bitted	571
A23170-12A	Arrow 'KA' keyed alike 4	571
A23170-12D	Arrow 'KD' keyed different	571
A23167-012	Corbin 60 'O' bitted	571
A23167-12D	Corbin 60 'KD' keyed different	571
A23174-012	Corbin Russwin L4 'O' bitted	571
A23168-012	Russwin D1 'O' bitted	571
A23168-12D	Russwin D1 'KD' keyed different	571
A23166-012	Sargent LA 'O' bitted	571
A23166-12D	Sargent LA 'KD' keyed different	571
A23160-012	Schlage C 'O' bitted	571
A23160-12A	Schlage C 'KA' keyed alike 4	571
A23160-12D	Schlage C 'KD' keyed different	571
A23159-012	Schlage E 'O' bitted	571
A23169-012	Yale 8 (Para) 'O' bitted	571
A23169-12D	Yale 8 (Para) 'KD' keyed different	571
A23158-012	Yale GA 'O' bitted	571

Options and accessories

Latches— $\frac{1}{2}$ " projection, standard, UL listed

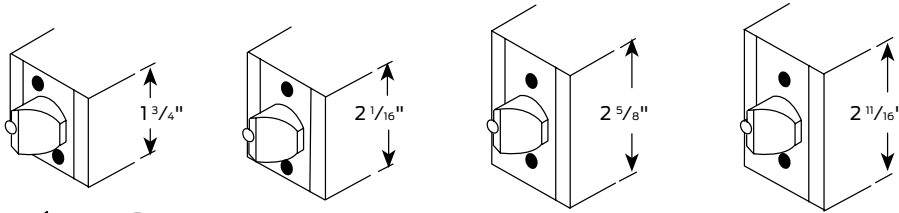

Latches for RU Series locks are $2\frac{3}{4}$ " backset for $1\frac{3}{4}$ " thick door.
Specify finish: 605, 606, 612, 613, 625, 626.

Catalog number	Description	Latch height
A31469-001	$2\frac{3}{4}$ " backset spring	$1\frac{3}{4}$ "
A31469-002	$2\frac{3}{4}$ " backset spring	$2\frac{1}{16}$ "
A31469-003	$2\frac{3}{4}$ " backset spring	$2\frac{5}{8}$ "
A31469-004	$2\frac{3}{4}$ " backset spring	$2\frac{11}{16}$ "
A31469-01D	$2\frac{3}{4}$ " backset deadlocking	$1\frac{3}{4}$ "
A31469-02D	$2\frac{3}{4}$ " backset deadlocking	$2\frac{1}{16}$ "
A31469-03D	$2\frac{3}{4}$ " backset deadlocking	$2\frac{5}{8}$ "
A31469-04D	$2\frac{3}{4}$ " backset deadlocking	$2\frac{11}{16}$ "

Latches— $\frac{3}{4}$ " projection, optional, UL listed

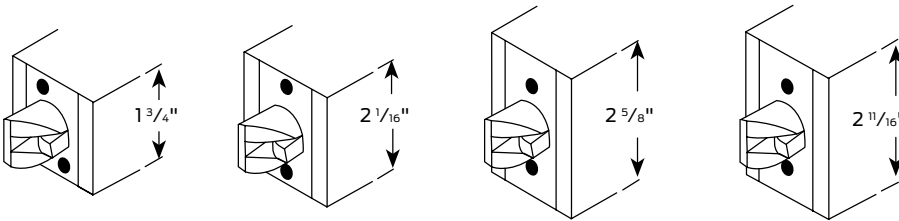

Latches for RU Series locks are $2\frac{3}{4}$ " backset, $1\frac{3}{4}$ " thick door.
Specify finish: 605, 606, 612, 613, 625, 626.

Catalog number	Description	Latch height
A31549-01D	$2\frac{3}{4}$ " backset deadlocking	$1\frac{3}{4}$ "
A31549-02D	$2\frac{3}{4}$ " backset deadlocking	$2\frac{1}{16}$ "
A31549-03D	$2\frac{3}{4}$ " backset deadlocking	$2\frac{5}{8}$ "
A31549-04D	$2\frac{3}{4}$ " backset deadlocking	$2\frac{11}{16}$ "

How to order

RU Series

For correct ordering, and to ensure no delays in shipment of your order, the following descriptive data must be listed in the sequence shown. Necessary information can be found in other parts of this catalog. The example below shows an order for 8 each RU locksets in the 521 Office function, D (Dane) trim design, 626 finish, 1 3/4" latch height, 4 7/8" ANSI strike, less cylinder, prepared for Russwin I/C core with 2 3/4" backset latch, to accommodate doors 1 3/4" thick.

- **Quantity:** Indicate the quantity required.
- **Catalog number:** Select catalog number. All catalog numbers shown in this catalog indicate 2 3/4" backset only. For thicker doors consult factory.
- **Trim design:** Indicate letter of lever design.
 - Example: A=Avalon; D=Dane; Q=Quantum.
- **Finish:** When the finish is the same for the outside and inside trim, it is shown once (626). For split finishes, the outside is designated first, then the inside (605 x 625).
- **Latches:** 2 3/4" backset only.
- **Strikes:** 4 7/8" X 1 1/4" ANSI standard. Optional retrofit strikes available: 3/4", 4 3/16" and 4 5/32". See page 13 for more details.
- **Cylinder type:** Locks are furnished with Falcon's standard cylinder unless otherwise specified. See page 8 for details. When ordered "less cylinder" it is necessary to indicate which competitor's standard cylinder or I/C core the lockset must be prepared for.
 - Example: Less cylinder - Prepared for Russwin I/C core and whether the cylinder is 6 or 7 pin.
- **Door hand:** Specify hand RH/LH or RHR/LHR so latch may be assembled to outer trim properly. Field reversible.
- **Keying detail:** We suggest using the standard terms developed by the Door & Hardware Institute.
 - Example: AA1 - Grand master keyed, master keyed, change key 1.
- **Keyways:** "G" is standard on regular cylinders, "A" is standard on interchangeable cores. Other keyways available. See page 10.

How to order example

Qty.	Catalog number	Trim design	Finish	Latch height*	Strike	Handing	Cylinder	Other requirements
8	RU521	D	626	1 3/4"	Std	RHR	Less cylinder	Prepare for Russwin I/C core

Finishes

The latest in modern techniques and equipment are used to apply the highest quality finish. Extra steps assure durable, consistent finishes and long useful life.

Although we apply the finest available protective plating and/or enamel coating to the surface of our products, these finishes have limitations and in time may deteriorate either from exposure to weather, pollution, perspiration, extremes

of climate, frequency of use or other factors. Deterioration of these finishes is, therefore, not a defect, but a normal process which is unavoidable. Our company cannot accept responsibility for finish deterioration in these circumstances and therefore the finishes cannot be guaranteed. These products will not be refinished or replaced under our warranty should deterioration of finishes occur.

Trim finishes chart

Description	ANSI No.	Available on
Bright brass	605	All trim
Satin brass	606	All trim
Satin bronze	612	All trim
Oil rubbed bronze	613	All trim
Bright chrome	625	All trim
Satin chrome	626	All trim

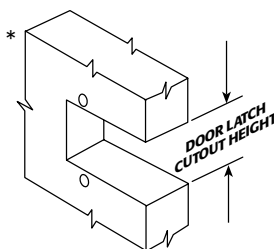

Latch heights currently identified and the manufacturer.

1. 1 3/4" Corbin, Russwin, Yale
2. 2 1/16" Corbin, Falcon
3. 2 5/8" Corbin, Sargent
4. 2 1/16" Russwin (Earliest)

Options and accessories

(continued)

Strikes

Furnished with a 4 7/8" ANSI Strike unless otherwise specified.

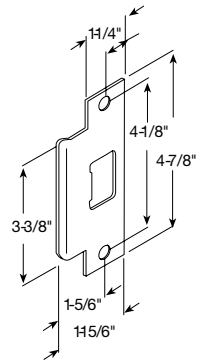

005164-000*
ANSI Prep A115.2

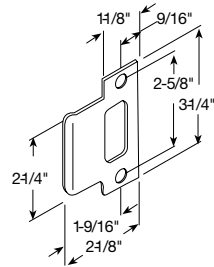

031471-000*
Early Corbin Russwin
single door

Note: Strike, door and lock same center line

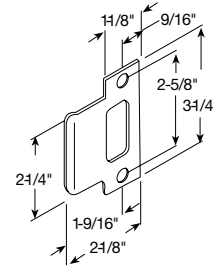

031471-001*
Early Corbin Russwin
single door

Note: Strike center line is not the same as door and lock

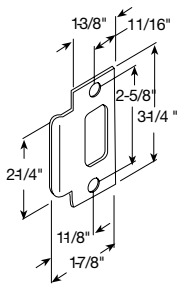

031472-000*
Early Corbin
Russwin pair
of doors

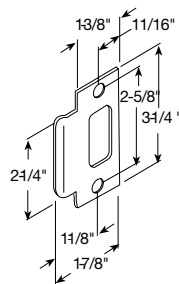

031473-000*
Yale mono pair
of doors

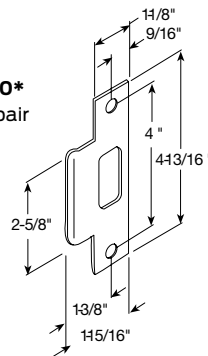

031474-000*
Early Corbin

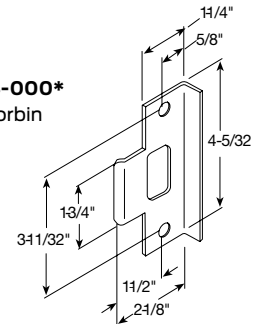

031477-000*
Early Russwin
unit lock

* Specify finish: 605, 606, 612 or 625, 626 or 630

Dust boxes

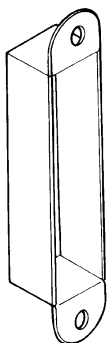

005099-000-30
1" deep. May be used with any 4 7/8" high (ANSI) strike.

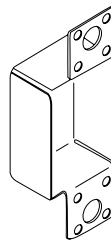

031453-000-30
3/4" deep. May be used with any 3 1/4" high strike.

Retrofit re-lever kits

Falcon Lock's mortise lock "Re-lever kits" are a quick, cost-effective solution to meeting ADA requirements. The Retrofit re-lever kit allows installation of our top quality levers without removing the locking unit. Retrofits most manufacturer's mortise knob locks—even older style cast versions—with a high quality Falcon lever in ten minutes or less.

Three easy steps:

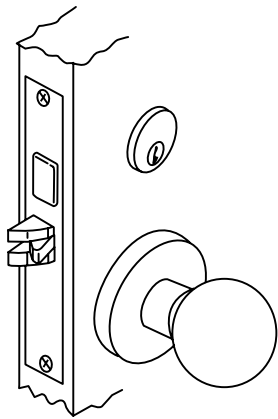

Step 1
Remove knob trim and cylinder.

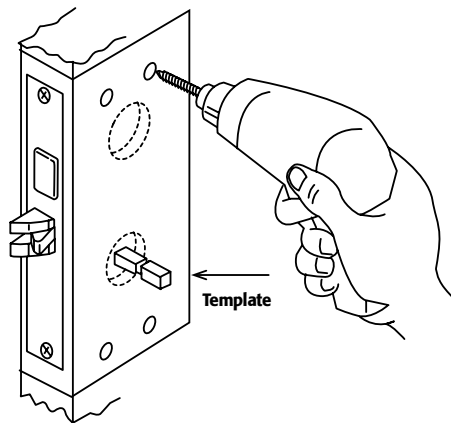

Step 2
Insert spindle from kit into hub.
Place enclosed template over
spindle and drill (4) holes.

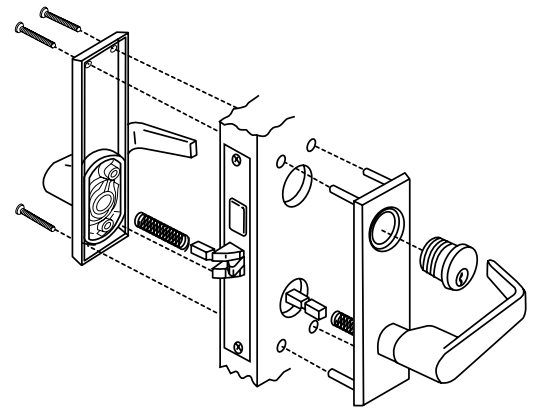

Step 3
Insert spindles in hubs and springs
in both levers. Position outer trim on
door, then through-bolt inner trim.
Reinstall cylinder, if necessary.

Falcon offers:

1. RW Series—Consists of a wrought, Napa style escutcheon with four mounting posts and die cast levers. Because the levers are die cast, the trim may be used on UL listed openings. Levers available: Avalon, Dane or Quantum.

How to order

Retrofit re-lever kits

For correct ordering, and to ensure no delays in shipment of your order, the following descriptive data must be listed in the sequence shown. Necessary information can be found in other parts of this catalog. The example below shows an order for 12 each RW leversets for use in the passage function, D (Dane) trim design, 626 finish, right hand door.

- **Quantity:** Indicate the quantity required.
- **Catalog number:** Select catalog number from below.
- **Trim design:** Indicate letter of lever design.
 - Example: A=Avalon; D=Dane; Q=Quantum.
- **Finish:** Specify ANSI finish number from below.
- **Function:** Specify current lock function for Retrofit.
- **Door hand:** Specify right hand or left hand.

How to order example

Qty.	Catalog number	Trim design	Finish	Function	Handing	Other requirements
12	RW340	D	626	For use on passage function	RH	Prepare for Russwin

Catalog numbers

Lock functions	Falcon	Arrow	Baldwin	Best	Corbin/ Russwin*	Lockwood	Sargent	Schlage**	Yale***	Marks
A. Passage	040	140	110	240	340	440	540	640	740	840
B. Privacy	041	141	111	241	341	441	541	641/645	741/745	841
C. Office/classroom/ storeroom	042	142	112	242	342/346	442	542	642/646	742/746	842
D. Entry/dormitory	043	143	113	243	343/347	443	543	643/647	743/747	843
E. Store door/public restroom/asylum	044	144	114	244	344/348	444	544	644/648	744/748	844

- A. Passage: No cylinder holes—outside or inside
- B. Privacy: Emergency hole outside —T-turn inside
- C. Office/classroom/storeroom: Cylinder hole outside—blank inside
- D. Entry/dormitory: Cylinder hole outside—T-turn inside

E. Store door/public restroom/asylum: Cylinder hole outside and inside

Note: Basic numbers for current products are listed. Consult factory for ordering numbers for older products or non-standard products.

* Corbin/Russwin 346, 347 and 348 are for 3 5/8" C to C with 1 1/2" master ring cylinder hole. All other Corbin/Russwin numbers are standard 3 3/8" C to C with standard mortise cylinder hole.

** Schlage K & L Series are for 3 55/64" C to C. K requires extra rotation. K requires 640, 645, 646, 647 and 648.

*** Yale 745, 746, 747 and 748 are for 3 1/2" C to C (old style Yale). All other Yale numbers are for 3 7/8" C to C (current Yale standard).

Trim finishes chart

Description	ANSI No.	Available on
Bright brass	605	All trim
Satin brass	606	All trim
Satin bronze	612	All trim
Oil rubbed bronze	613	All trim
Bright chrome	625	All trim
Satin chrome	626	All trim

* Consult current price book for finish availability by design.

Ordering information

1. Need sample lock chassis with spindle(s).
2. Specify center-to-center dimension of hub to cylinder.
3. Specify center-to-center dimension of hub to T-turn.
4. Specify exact spindle size (both inner & outer).

Conversion chart

RU Series Grade 1 Retrofit unit key-in-lever

ANSI number/grade	Function	Falcon	Corbin/Russwin	Old Corbin unit lock	Old Russwin unit lock	Old Yale mono-lock	Yale mono-lock retrofit	Old Falcon R Series
F75-1	Passage	RU101	UT5210	310	510	6201	6401	R101
F76-1	Privacy	RU301	UT5220	320	520	6202	6402	R301
F88-1	Vestibule	RU381	UT5272	354	546 1/2	6217	6417	R381
F87-1	Asylum	RU411	—	—	—	6230	—	R411
F82-1	Entry	RU501	UT5261	361	546	6204	6404	R501
F109-1	Entry/office	RU511	—	—	—	6207	6407	—
F81-1	Entry/office	RU521	UT5251	351	540	—	—	R521
F84-1	Classroom	RU561	UT5255	355	540 5/8	6208	6408	R561
F90-1	Dormitory	RU571	—	—	—	6222	6422	R571
F86-1	Storeroom	RU581	UT5257	357	552	6205	6405	R581
—	Storeroom	—	—	—	—	—	—	—
	(Electrified fail-safe)	RU851	—	—	—	—	—	—
	(Electrified fail-secure)	RU881	—	—	—	—	—	—

Trim styles

Falcon	Corbin/Russwin	Old Corbin unit lock	Old Russwin unit lock	Old Yale mono-lock	Yale mono-lock Retrofit	Old Falcon R Series
Avalon	—	912L	Beaulev	Jefferson	MO	—
Dane	Essex	912LR	Moderalev	Saxon	AU	—
Quantum	—	—	—	—	PB	—

All effort has been made to make this information comprehensive. Since no two products are exactly alike, this data represents those products which are similar. This information was obtained from trade services and is not guaranteed nor meant to represent any product as equal to any other product.

T Series

Grade 1, extra heavy-duty
cylindrical lever locks

Simply put, the Falcon T Series lock is the most versatile lockset in the industry. This extra heavy duty lock can accept any manufacturer's cylinder, and the cylinder can easily be removed for quick, easy re-keying. Redesigned with a compression spring behind the cylinder, the T Series is now stronger than ever and lever sag has been virtually eliminated. This adaptable lock is well suited to either new construction or retrofit use in buildings as varied as multi-family, retail, institutional and government/military.

Features

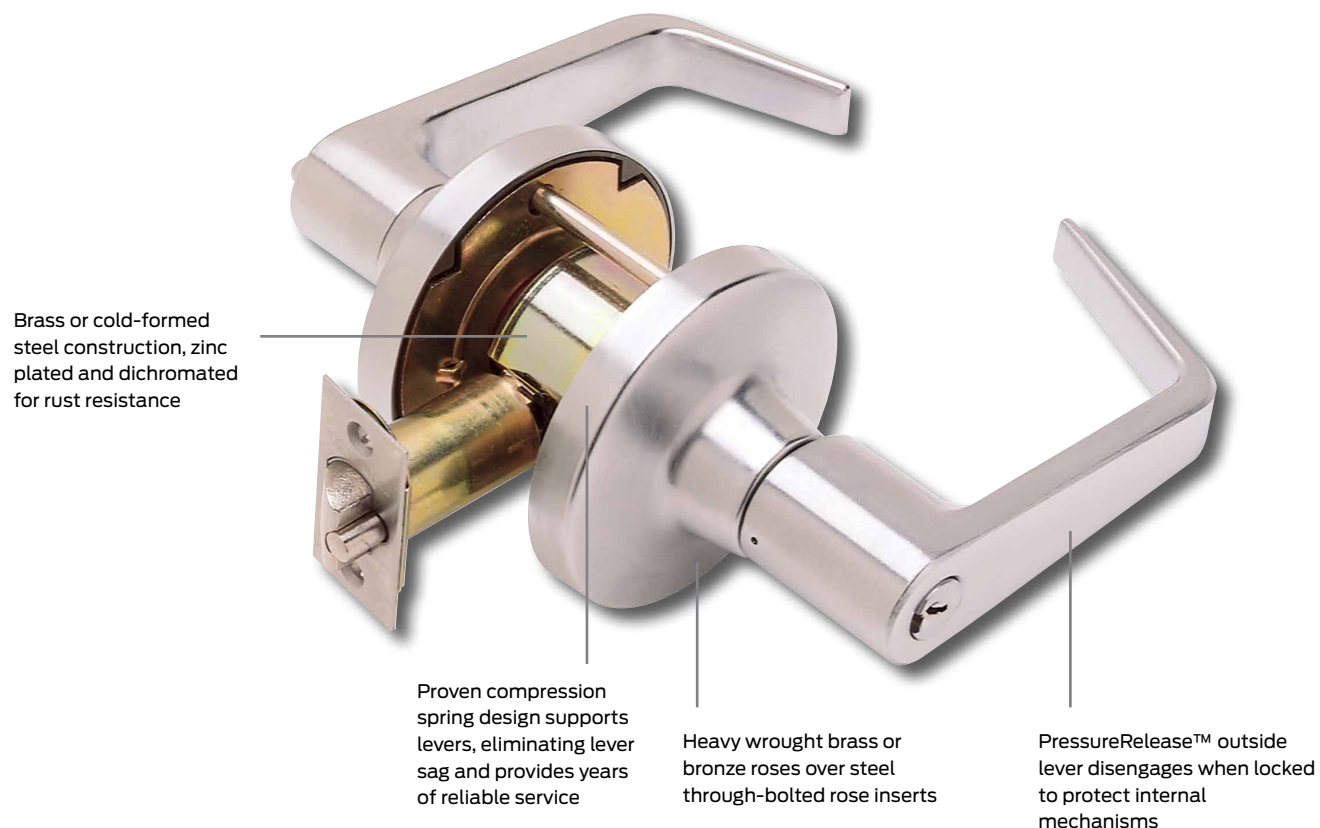

Cylindrical locks

Features

Door thickness: 1 3/4" to 2 1/8" standard. Thin door adapter kit (A30775-000-00) available for doors thinner than 1 3/4", please specify door thickness.

Backset: 2 3/4" standard. 2 3/8" also available. Link (A22161-005-10) available for 5" backset.

Mechanism: Parts constructed of brass or cold formed steel, zinc plated and dichromated for rust resistance. Springs are stainless steel.

Attachment: Lock chassis secured to door by threaded mounting nuts. Completely preassembled outer trim and inner spindle assembly are through-bolted over chassis using (2) 10-32 screws. Adding rose and lever to inner spindle assembly completes installation.

Handing: Locks are non-handed.

Cylinders: Drilled with 6-pin chambers, pinned in 5. Pinning in 6 chambers available when specified, at no cost. 7-pin cylinders also available. Cylinder assemblies removable to rekey. Also available with 6 or 7-pin interchangeable core cylinders. Cylinder housings and plugs machined from solid brass. Springs are phosphor bronze. Two nickel silver keys furnished standard. Interchangeable core design is available for small format (SFIC) and large format for most manufacturers, see page 8.

Keyways: "G" keyway standard on conventional cylinders. "A" keyway standard on I/C core cylinders. Also available with some optional keyways.

Trim: Roses are heavy wrought brass or bronze, installed over pressure cast rose inserts which are through-bolted through door. Levers are pressure cast (solid levers—no inserts) material finished to match mating parts.

Latches: 9/16" bolt projection, UL listed with latch faceplates 2 1/4" x 1 1/8" with square corners standard. 3/4" projection, UL listed latch with 2 3/4" backset also available. Adjustable front standard. See page 10 for optional latches.

Strikes: 4 7/8" x 1 1/4" ANSI strike with curved lip to meet ANSI A115.2 door frame preparation standard. Consult page 11 for other available strike sizes and configurations.

Screws: Furnished with combination screws for use in wood or metal doors and frames.

Electrified functions: Available in 24 VDC .185 AMP.

ANSI/BHMA: Meets ANSI/BHMA A156.2, Series 4000, Grade 1.

UL: 3 hour A label.

T Series specifications

Key-in-lever cylindrical locksets shall be Falcon lock T Series or equal and meet the following requirements:

- All locks shall meet the new ANSI/BHMA A156.2, Series 4000, Grade 1 for key-in-lever locksets.
- Locksets shall be UL Listed (3 hour A Label).
- Locksets shall be provided standard with Pressure Release™ feature. When outside lever is locked, it is not rigid but will move freely without operating the latch bolt.
- Lever trim shall have individual heavy-duty compression springs behind rose for lever return and to prevent lever sag. Trim shall be through-bolted with two (2) 10-32 screws coated with thread sealant to provide strength and resistance to loosening. Inner and outer trim shall "bottom out" to prevent door collapse. Roses shall be minimum of 3 1/2" diameter.
- All lever designs shall be solid and meet the federal ADA and state disability requirements. Inside levers shall be attached by Allen-head set screw to prevent tampering or vandalism.
- Locksets shall adjust to fit door thickness from 1 3/4" to 2 1/8".
- All locksets shall be non-handed and not require field disassembly for re-handing.
- Preparation for door must be non-handed. Acceptable manufacturer: Falcon lock

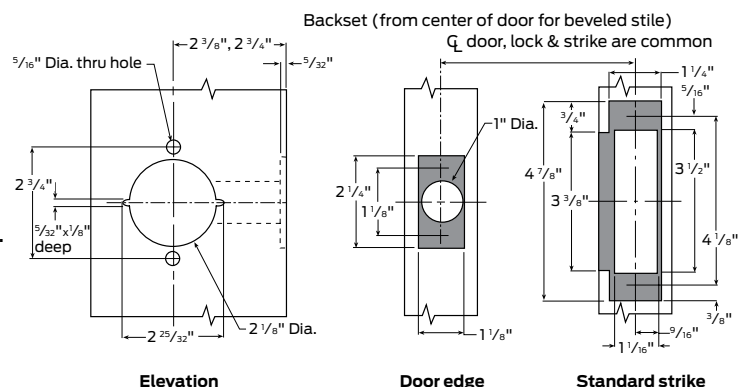

Levers

Levers are solid pressure cast zinc, finished to match mating parts. Roses are wrought brass or bronze installed over steel throughbolted rose inserts. Pressure Release™ levers are standard. Levers are secured by a spring-loaded retainer. Retainer cannot be depressed when locks have been locked.

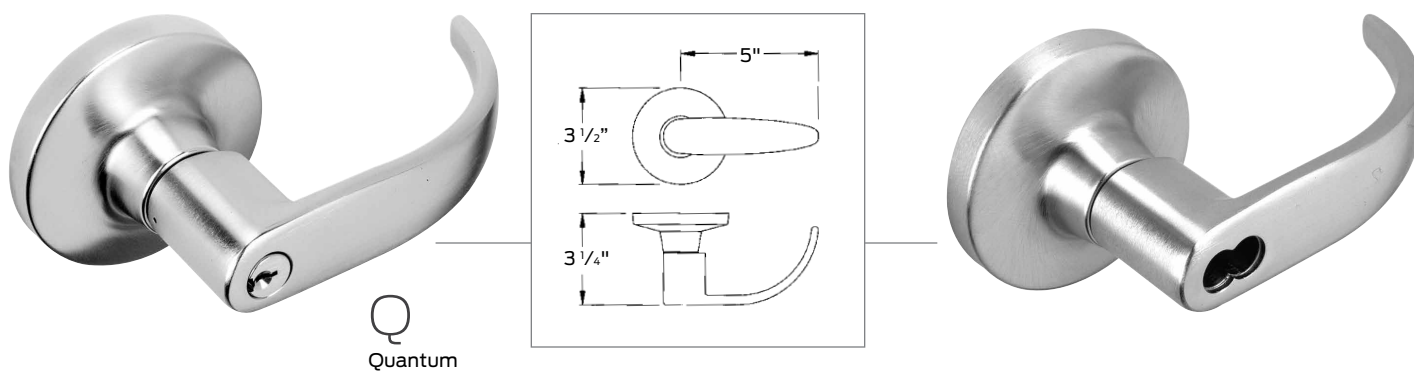
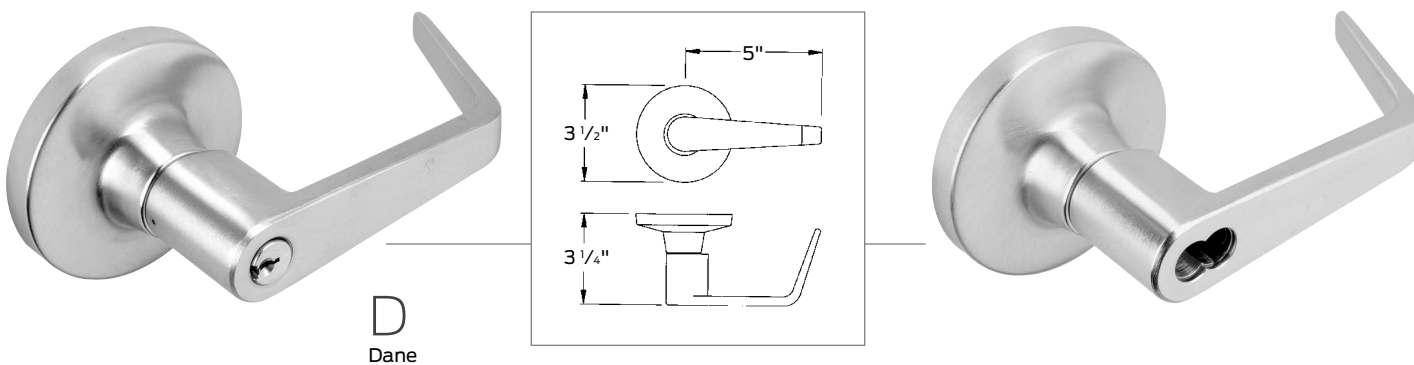
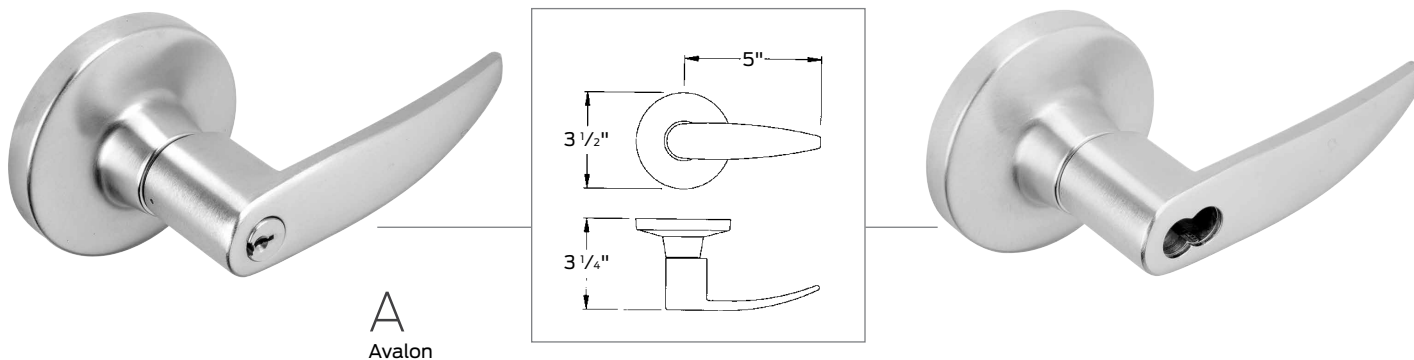

Abrasive coated levers

All levers are available with abrasive coating along the length of the lever to identify entrances to hazardous areas to the handicapped. To order add: "with abrasive coated outer lever" in detail section of order.

High performance compression springs

Falcon T series locks feature our high performance compression springs. This newly designed spring far exceeds ANSI/BHMA requirements for cycle tests, and ensures the most robust support for levers. Unlike typical torsion springs that can break at the bend points, this new design will provide years of reliable service even in high-use applications. A retrofit kit is available to outfit your existing T series locks with this new, more robust spring design.

Machined steel lever spindle carries high levels of torque and shear. This spindle is re-used when upgrading existing locks to the new design.

Heavy-duty case zinc rose insert accommodates the new style spring. This insert is replaced when upgrading to the new design.

New stamped steel torque plates hold the springs in place and transfer the spring energy to the spindle and lever assembly.

Stainless steel compression springs replace steel torsion springs, providing the most reliable and robust method of supporting levers.



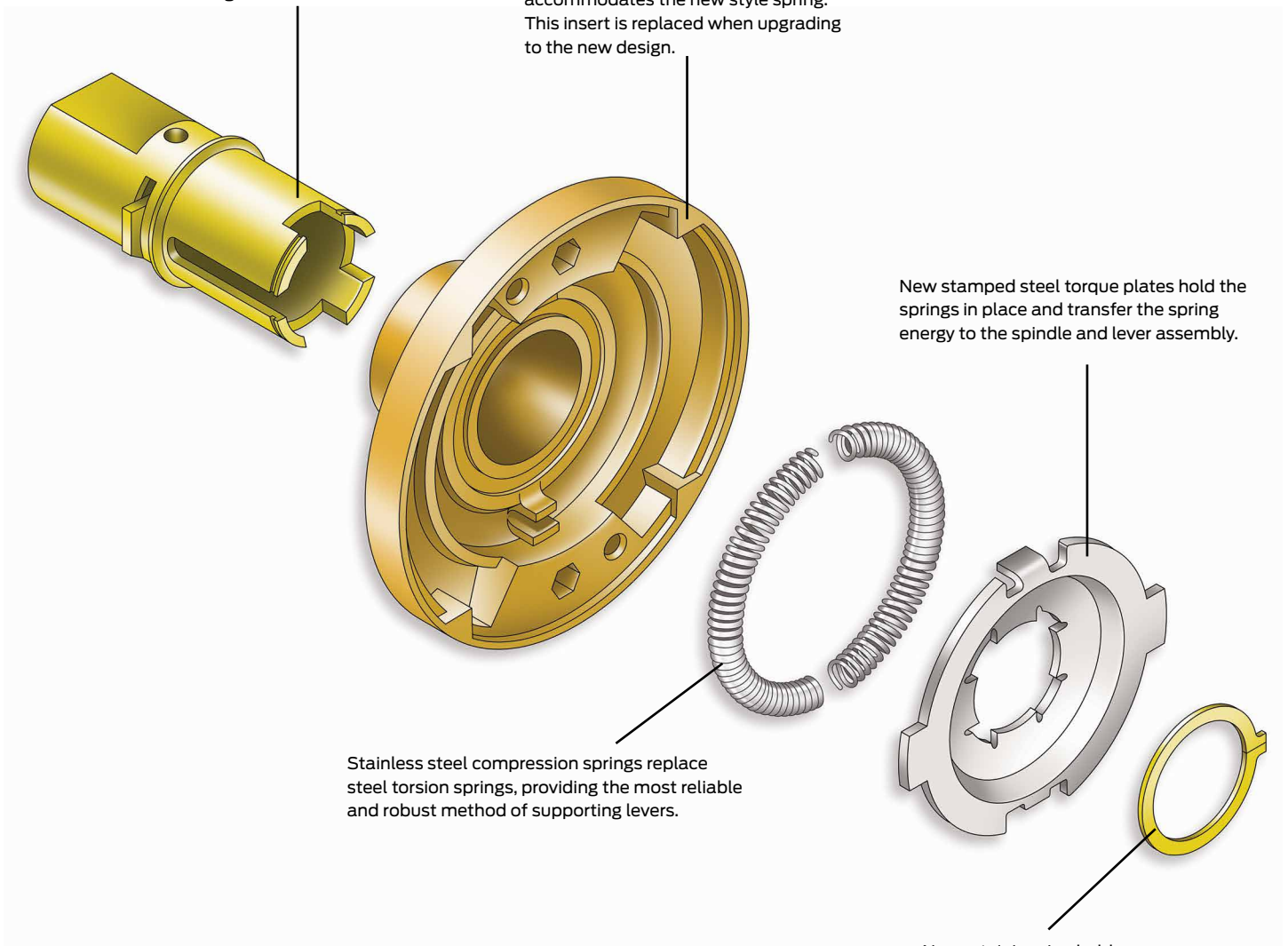







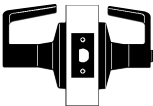
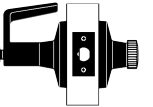

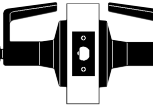

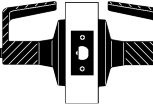

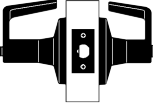

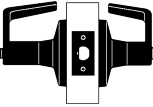

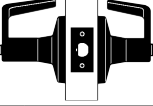

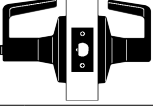
New retaining ring holds the assembly together.

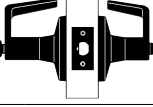

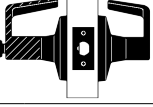
Functions

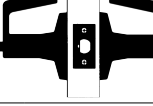
To order Falcon T Series locksets, please consult page 29 for ordering information and assistance.

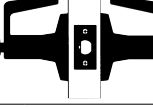
 Indicates interchangeable core available.

Catalog number	Function	Description	ANSI no. & grade
T101		Passage/closet latchset—Latch bolt by levers at all times.	F75-1
T301		Privacy lock—Latch bolt by levers. Outside lever locked by push button in inside lever. Rotating inside lever or closing door releases push button. Emergency release in outside lever unlocks door.	F76-1
T351	 	Closet lock—Deadlocking latch bolt by turn knob inside or lever outside except when outside lever is locked by key.	
T381	 	Classroom security lock—Deadlocking latch bolt by levers from either side except when outside lever is locked by key from inside. Outside key only retracts latch. Outside lever is locked and unlocked only by inside key.	F88-1
T411	 	Asylum lock—Deadlocking latch bolt operated by key in lever from either side. Both levers always inoperable.	F87-1
T501	 	Entry lock—Push button locking. Button on inside locks outside lever until unlocked by key or by rotating inside lever. Inside lever always free. Deadlocking latch bolt.	F82-1
T511	 	Entry/office lock—Turn/push button locking. Pushing and turning button locks outside lever requiring use of key until button is manually unlocked. Push button locking. Pushing button locks outside lever until unlocked by key or by rotating inside lever. Inside lever always free. Deadlocking latch bolt.	F109-1
T521	 	Office lock—Turn button locking. Turning button locks outside lever requiring use of key until button is manually unlocked. Inside lever always free. Deadlocking latch bolt.	F81-1
T561	 	Classroom lock—Deadlocking latch bolt by levers. Outside lever is locked by key in outside lever. Inside lever is always free.	F84-1
T571	 	Dormitory lock - Deadlocking latch bolt by levers except when locked by push button in inside lever. Key in outside lever locks or unlocks outside lever and releases button. Closing door releases push button. Inside lever always free.	F90-1
T581	 	Storeroom lock—Deadlocking latch bolt by lever inside or key outside. Outside lever is inoperable. Inside lever always free.	F86-1
T851	 	Storeroom (electrified – fail safe)—Inside Lever Always Free. Latch bolt operated by lever from either side except when outer lever is electrically locked. When outer lever is locked (inoperable), latch bolt retracted by key in cylinder outside. 24 volt DC .185 Amps, continuous duty.	
T881	 	Storeroom (electrified – fail secure)—Inside lever always free. Deadlocking latch bolt operated by lever inside at all times. Outside lever inoperable until electrically unlocked, then latch bolt from either side. When outside lever is inoperable latch bolt retracted by key in cylinder outside. 24 volt DC .185 Amps, continuous duty..	
T12		Dummy trim—Single trim-surface mounted rigid lever.	

Cylinders

The Falcon T Series accepts the following competitors standard 6-pin cylinders and interchangeable cores:

Standard 6-pin cylinders*

- Arrow
- Assa
- Corbin Russwin
- Lori
- Medeco
- Primus (Schlage)
- Sargent
- Schlage
- Yale

I/C removable cores*

- Arrow
- Best
- Corbin Russwin
- Medeco Keymark
- Medeco 32 Series
- Peaks (Kaba)
- Primus (Schlage)
- Sargent
- Schlage
- Yale

*Locks must be modified for some cylinders. Be sure to specify manufacturer when ordering.

Falcon interchangeable cores

Catalog number	Description
C606	For use in all T Series I/C keyed locks – 6-pin (cover style)
C607	For use in all T Series I/C keyed locks – 7-pin (cover style)
CB806	For use in all T Series I/C keyed locks – 6-pin (cap style)
CB807	For use in all T Series I/C keyed locks – 7-pin (cap style)

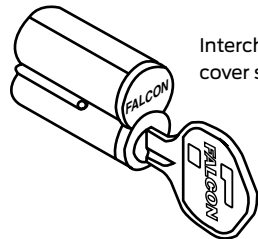

Interchangeable core cover style

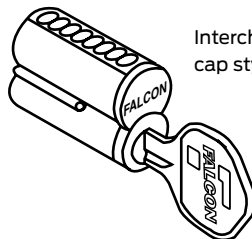

Interchangeable core cap style

Falcon standard cylinders

Catalog number			
5-Pin cylinder	6-Pin cylinder	7-Pin cylinder	Function
A23151-05	A23161-05	A23171-05	All except 381 I/S, 571
A23151-06	A23161-06	A23171-06	381 Inside cylinder
A23151-07	A23161-07	A23171-07	571

Note: Specify finish: 606 or 626. Specify keyway: "E", "G" (standard), "H", "K", "L", "N", "P".

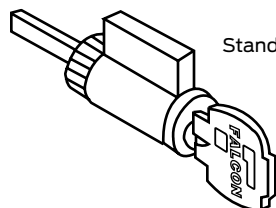

Standard cylinder

Competitor keyways

Standard cylinders with competitor keyways - 6

Catalog number	Description	Function
A23167-000	Corbin 60 'O' bitted	all except 381 IS, 571
A23167-OKD	Corbin 60 'KD' keyed different	all except 381 IS, 571
A23168-000	Russwin D1'O' bitted	all except 381 IS, 571
A23168-OKD	Russwin D1 'KD' keyed different	all except 381 IS, 571
A23174-000	Corbin/Russwin L4 'O' bitted	all except 381 IS, 571
A23166-000	Sargent LA 'O' bitted	all except 381 IS, 571
A23166-OKD	Sargent LA 'KD' keyed different	all except 381 IS, 571
A23160-000	Schlage C 'O' bitted	all except 381 IS, 571
A23160-OKA	Schlage C 'KA' keyed alike 4	all except 381 IS, 571
A23160-OKD	Schlage C 'KD' keyed different	all except 381 IS, 571
A23159-000	Schlage E 'O' bitted	all except 381 IS, 571
A23169-000	Yale 8 (PARA) 'O' bitted	all except 381 IS, 571
A23169-OKD	Yale 8 (PARA) 'KD' keyed different	all except 381 IS, 571
A23167-011	Corbin 60 'O' bitted	381 inside
A23167-11D	Corbin 60 'KD' keyed different	381 inside
A23168-011	Russwin D1'O' bitted	381 inside
A23168-11D	Russwin D1 'KD' keyed different	381 inside
A23174-011	Corbin/Russwin L4 'O' bitted	381 inside
A23166-011	Sargent LA 'O' bitted	381 inside
A23166-11D	Sargent LA 'KD' keyed different	381 inside
A23160-011	Schlage C 'O' bitted	381 inside
A23160-11A	Schlage C 'KA' keyed alike 4	381 inside
A23160-11D	Schlage C 'KD' keyed different	381 inside
A23159-011	Schlage E 'O' bitted	381 inside
A23169-011	Yale 8 (PARA) 'O' bitted	381 inside
A23169-11D	Yale 8 (PARA) 'KD' keyed different	381 inside
A23167-012	Corbin 60 'O' bitted	571
A23167-12D	Corbin 60 'KD' keyed different	571
A23168-012	Russwin D1'O' bitted	571
A23168-12D	Russwin D1 'KD' keyed different	571
A23174-012	Corbin/Russwin L4 'O' bitted	571
A23166-012	Sargent LA 'O' bitted	571
A23166-12D	Sargent LA 'KD' keyed different	571
A23160-012	Schlage C 'O' bitted	571
A23160-12A	Schlage C 'KA' keyed alike 4	571
A23160-12D	Schlage C 'KD' keyed different	571
A23159-012	Schlage E 'O' bitted	571
A23169-012	Yale 8 (PARA) 'O' bitted	571
A23169-12D	Yale 8 (PARA) 'KD' keyed different	571

Options and accessories

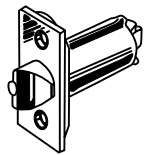

Square corner
9/16"

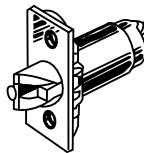

Square corner
3/4"

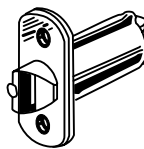

9/16" Radius corner
9/16" Projection



3 Hour



Latches—Grade 1, UL listed

Catalog number	Description	Faceplate size	Corner	Projection
A98535-000	2 3/4" Backset spring	2 1/4" x 1 1/8"	Square	9/16"
A98535-00D	2 3/4" Backset deadlocking	2 1/4" x 1 1/8"	Square	9/16"
A98538-000	2 3/4" Backset spring	2 1/4" x 1 1/8"	Radius 9/16"	9/16"
A98538-00D	2 3/4" Backset deadlocking	2 1/4" x 1 1/8"	Radius 9/16"	9/16"
A98835-OSD	2 3/4" Backset deadlocking	2 1/4" x 1 1/8"	Square	3/4"
A98838-OSD	2 3/4" Backset deadlocking	2 1/4" x 1 1/8"	Radius 9/16"	3/4"

Note: Specify finish 606, 612, 613, 630

Latches for T Series locks are UL Listed. 2 3/4" backset standard.

1" width latch face minimum. Unless otherwise specified, we furnish a 2 1/4" x 1 1/8" x square corner faceplate on 2 3/4" backset latches front standard.

Latches—Grade 2, UL listed for flat or beveled doors

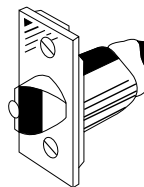

Square corner
1/2" projection

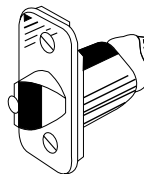

1/4" Radius corner
1/2" projection



3 Hour



Catalog number	Description	Faceplate size	Corner	Projection
A92320-000	2 3/8" Backset spring	2 1/4" x 1"	Square	1/2"
A92320-00D	2 3/8" Backset deadlocking	2 1/4" x 1"	Square	1/2"
A92321-000	2 3/8" Backset spring	2 1/4" x 1"	Radius	1/2"
A92321-00D	2 3/8" Backset deadlocking	2 1/4" x 1"	Radius	1/2"
A92330-000	2 3/4" Backset spring	2 1/4" x 1"	Square	1/2"
A92330-00D	2 3/4" Backset deadlocking	2 1/4" x 1"	Square	1/2"
A92331-000	2 3/4" Backset spring	2 1/4" x 1"	Radius	1/2"
A92331-00D	2 3/4" Backset deadlocking	2 1/4" x 1"	Radius	1/2"

Note: Specify finish 606, 612, 613, 630

Latches for T Series locks are UL Listed.

These grade 2 latches have self-adjusting fronts to accommodate beveled or flat front doors. Unless otherwise specified, we furnish a 2 1/4" x 1" x square corner faceplate on these latches.

Options and accessories

(continued)

Strikes

Furnished with a 4 7/8" ANSI Strike unless otherwise specified.

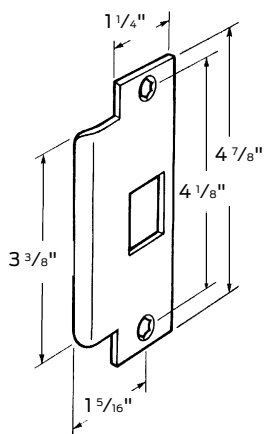

005164-000
ANSI prep A115.2

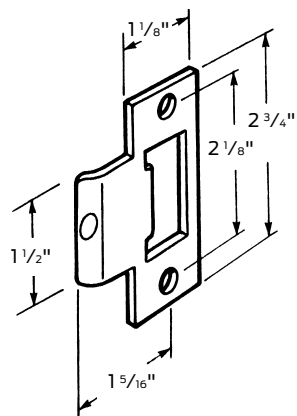

A05185-000
T-strike square corner

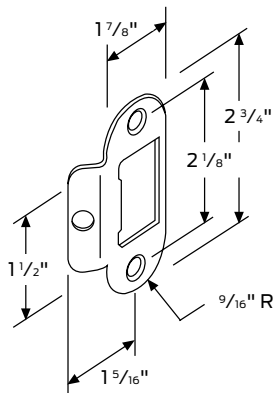

A05185-004
T-strike 9/16" radius

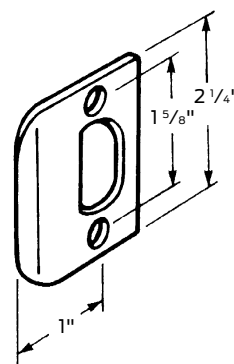

Q001-049
Full lip, square corner

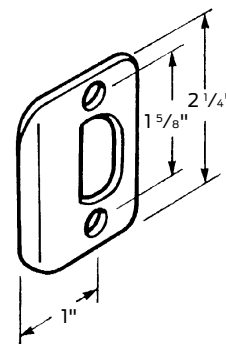

Q001-048
Full lip, 1/4" radius corner

Long backset extension link

A22161-005-00 Link for 5" Backset for use with 2 3/4" backset latches (except 3/4" projection).

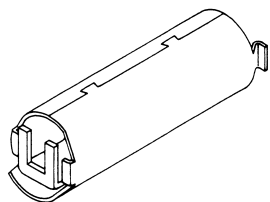

A22161-005-00

Dust boxes

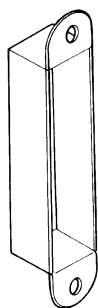

K510-066-PLA
(EC 3604)
1" deep. May be used with any 4 7/8" high (ANSI) strike.

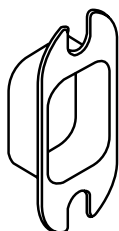

012191-003-70
1/2" deep. May be used with any 2 3/4" high (T) strike.

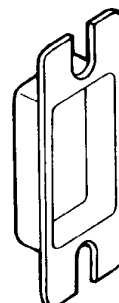

Q001-059
7/16" deep. May be used with any 2 1/4" (full lip) high strike.

Construction keying

Falcon offers two different construction key systems depending on the size of and application within the project. Both systems permit the installation and use of regular door locks during construction, yet completely preserve the security of the keying system for the ultimate building owner. The Master, Grand Master and change keys are never with the locks during the construction phase of a building. Only the “construction” keys are sent to the job site. Where the job permits, we will utilize the “Lost pin system” as our standard system for construction keying. Larger or more complicated jobs may require the use of our “Blockokey® System” for construction keying.

“Disposable construction” interchangeable cores

This newly designed disposable construction core (1408) is an inexpensive alternative to interior keyed construction cores. This core should be used on interior door applications or where security on a site is not a concern. No keys need to be issued. The disposable core is inserted in the lever or knob and is operated by a thumb turn, which retracts the latch bolt. Please use either brass or permanent construction cores on exterior doors or secured areas.

Locks with “Lost pin system”

Our “lost” pin construction key system consists of one construction pin and a shallow hole in the side of the plug.

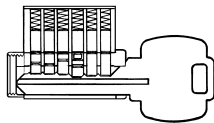

Construction key—KB566

When the “construction” key is used, the construction pin is always in the cylinder plug, sitting on top of the bottom pin. consists of one construction pin and a shallow hole in the side of the plug.

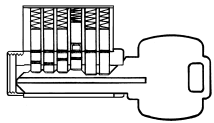

Master key—KB578

When the Master key is inserted, the construction pin is pushed up into the cylinder housing. As the Master key is rotated to the right, the construction pin will drop into the hole in the plug, thereby eliminating any future use of the construction key.

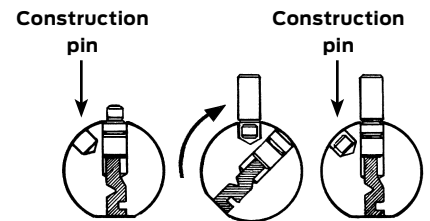

Locks with Blockokey® cylinders

All lock cylinders on a specific project are operable by a special “project key.” Duplicates of this key may be assigned by the building contractor to workmen and subcontractors as required. No regular change keys or Master keys are needed on the job. This eliminates the possibility of subsequent exposure from lost or stolen keys.

How to order locks with Blockokey® cylinders

Blockokey® locksets are ordered by adding the word “Blockokey” after the balance of the ordering information.

Example: 72 Each B511 D 626 1AA-72AA (Blockokey)

How locks with Blockokey® cylinders are used

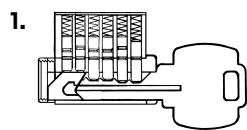

Project key—KB531

Lock cylinder is operated by the special “project key.” The last two pins in the cylinder are held inoperative by the key block.

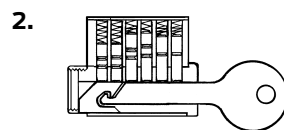

Removal tool—KB536

The special “project key” is canceled out by removal of the key block. A key block removal tool is furnished with the Master keys for the locks. Simply push the removal tool into the keyway, then withdraw it to remove the block. Thereafter, the “project key” will no longer operate the lock cylinder.

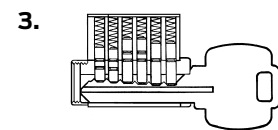

Change or master key—KB578

Cylinder is now only operable by the regular change key or Master key.

Conversion chart

T Series Grade 1 heavy duty cylindrical key-in-lever lock

ANSI no./Grade	Function	Falcon	Arrow	Best	Corbin/Ruswin	Marks	Sargent	Yale
F75-1	Passage	T101	H01	93KN	CL3310	95N	10U15	5401LN
F76-1	Privacy	T301	H02	93KL	CL3320	95L	10U65	5402LN
	Closet	T351	-	93RZ	CL3391	-	-	5407LN
F88-1	Classroom security	T381	H32	93KC	CL3372	95DA	10G16	5417LN
F87-1	Asylum	T411	H33	93KW	CL3332	95DW	10G17	5430LN
F82-1	Entry	T501	H13	93KB	CL3361	95B	10G24	5404LN
F109-1	Dormitory	T511	-	93KAB	CL3351	95AB	-	-
F81-1	Entry/office	T521	H11	93KAB	-	95A	10G05	5407LN
F84-1	Classroom	T561	H17	93KR	CL3355	95S	10G37	5408LN
F90-1	Dormitory	T571	H19	93KT	-	95T	10G54	5422LN
F86-1	Storeroom	T581	H12	93KD	CL3357	95F	10G04	5405LN
	Storeroom-fail safe	T851	-	93DEL	-	95FEL	10G70	-
	Storeroom-fail secure	T881	-	93DEU	-	95FEU	10G71	-
	Dummy-single	T12	H08	1DT	CL3350	95DO	10U94	455LN

Trim styles

Falcon	Arrow	Corbin/Best	Ruswin	Marks	Sargent	Yale
Dane	SR	15D or L	NZD	195/195R	LL	AU
Quantum	-	14D or L	PZD	295/295R	LP	PB
Avalon	-	16D or L	AZD	-	LB	MO

All effort has been made to make this information comprehensive. Since no two products are exactly alike, this data represents those products which are similar. This information was obtained from trade services and is not guaranteed nor meant to represent any product as equal to any other product.

How to order

For correct ordering, and to ensure no delays in shipment of your order, the following descriptive data must be listed in the sequence shown. Necessary information can be found in other parts of this catalog. The example below shows an order for 12 each T locksets in the 571 Dormitory function, D (Dane) trim design in a 626 (satin chrome) finish, with 2 3/4" backset latch, to accommodate doors 1 3/4" thick.

- **Quantity:** Indicate the quantity required.
- **Catalog number:** Select function number, cylinder type, and latch style from tables in this section.
- **Trim design:** Indicate letter of lever design required.
 - Example: AVA=Avalon; DAN=Dane; QUA=Quantum.
- **Finish:** When the finish is the same for the outside and inside trim, it is shown once (626). For split finishes, the outside is designated first, then the inside (605 x 625).
- **Latches:** 2 3/4" backset is standard. Adjustable front standard. A Grade 2 latch with a 1" faceplate in 2 3/8" and 2 3/4" backset also available. See page 10. All latches are UL listed 3 Hour.
- **Strikes:** 4 7/8" x 1 1/4" ANSI standard. Optional T-strike or full lip strike available. See page 11.
- **Cylinder type:** 6 pin is standard. For 7-pin add PD7 to product catalog numbers (eg. T501PD7 QUA).
- **Keying detail:** We suggest using the standard terms developed by DHI (Door and Hardware Institute) or ALOA (Associated Locksmiths of America Inc).
 - Example: AA1 - Grand Master keyed, Master keyed, change key 1.
- **Interchangeable core:** To order product capable of accepting an interchangeable core, add suffices from the keying table to the function number, preceding the latch style.
 - Example: T511JD will be supplied with a FSIC prepped lever to accept a competitor full size interchangeable core.
- **Keyways:** "G" is standard on regular cylinders, "A" is standard on interchangeable cores. Other keyways available. See current pricebook.
- **Additional keys:** Note the total number of keys required.
- **Large bow keys:** Add—"with large bow keys."

How to order example

Line item	Qty.	Product	Outside		Inside		Hand	Latch	Strike	Door thickness	Ext.	DIM	Additional details/keying
			Des	Fin	Des	Fin							
1	20	T571JD	Dan	626				98535	5164	1 3/4"			With 012191-003-70 dust box. FSIC prep IC-YA6

Finishes

The latest in modern techniques and equipment are used to apply the highest quality finish. Extra steps assure durable, consistent finishes and long useful life.

Although we apply the finest available protective plating and/or enamel coating to the surface of our products, these finishes have limitations and in time may deteriorate either from exposure to weather, pollution, perspiration, extremes

of climate, frequency of use or other factors.

Deterioration of these finishes is, therefore, not a defect, but a normal process which is unavoidable. Our company cannot accept responsibility for finish deterioration in these circumstances, and therefore the finishes cannot be guaranteed. These products will not be refinished or replaced under our warranty should deterioration of finishes occur.

Trim finishes chart

Description	ANSI No.	Available on
Bright brass	605	All trim
Satin brass	606	All trim
Satin bronze	612	All trim
Oil rubbed bronze	613	All trim
Bright chrome	625	All trim
Satin chrome	626	All trim

X Series

Grade 1, heavy-duty cylindrical knob locks

When you need a tough, reliable lock that can also withstand the corrosive conditions of a marine environment you need a Falcon X Series lock with our XC construction. The XC option provides a stainless steel and nonferrous constructed chassis that, when paired with stainless steel trim, provides a Grade 1 lock that is resistant to corrosion when exposed to moisture and salt. This full knob line features an interchangeable core that can be removed for quick, easy re-keying. Our interchangeable cores are compatible with SFIC products from other manufacturers. And they're backed by one of the best names in the business.

Features

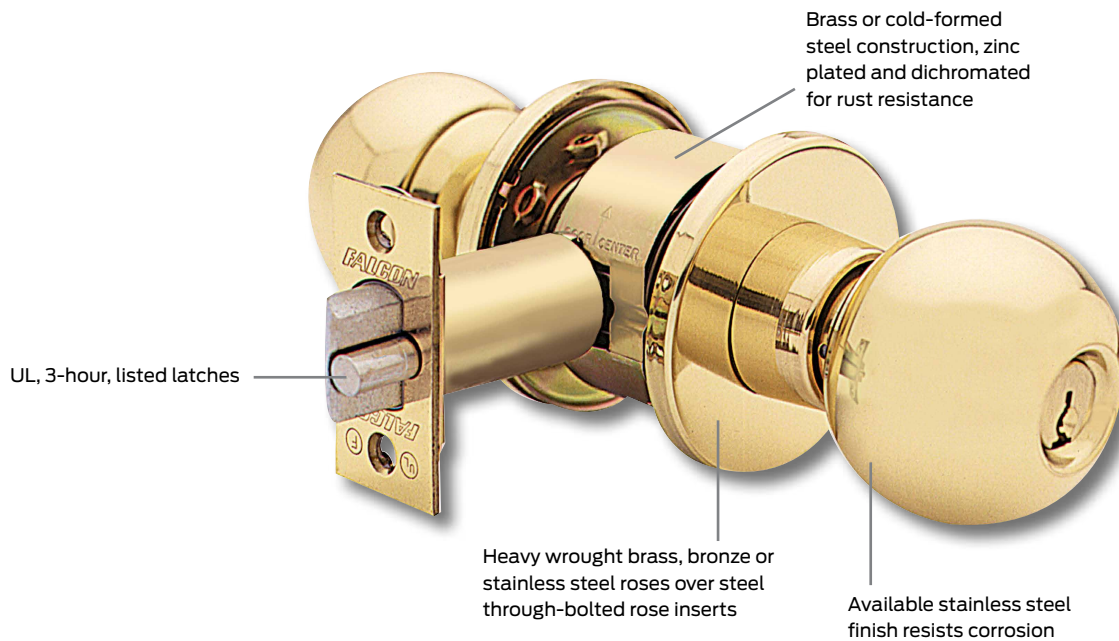

Cylindrical locks

Features

Door thickness: 1 3/8" to 1 7/8" doors. Locks for thicker doors also available. Consult factory.

Backset: 2 3/4" standard. 2 3/8" also available.

Mechanism: Parts constructed of brass or cold formed steel, zinc plated and dichromated for rust resistance. Springs are stainless steel. XC Series available with all internal parts of stainless steel or other nonferrous materials.

Attachment: Locks secured to door by threaded collars. Inner collar tightened by special wrench furnished with each lock. Outer rose contains locking plate to prevent unauthorized removal.

Handing: Specify hand of door when ordering. Field reversible.

Cylinders: Drilled with 6-pin chambers, pinned in 5. Pinning in 6 chambers available when specified, at no cost. 7-pin cylinders available in Hana design. Cylinder assemblies removable to rekey or change hand of lock. Also available with 6 or 7-pin interchangeable core cylinders—Elite and Troy designs. Cylinder housings and plugs machined from solid brass. Springs are phosphor bronze. Two nickel silver keys furnished standard. See page 8.

Keyways: "G" keyway standard on standard cylinders. "A" keyway standard on I/C core cylinders. Also available with other keyways and some competitor keyways. See pages 9-10.

Trim: Roses are heavy wrought brass, bronze or stainless steel, installed over wrought steel reinforcing plates. Knobs are brass, bronze or stainless steel secured by a steel knob retainer which cannot be depressed when lock has been locked. See individual designs on pages 5-6 for details.

Latches: 9/16" bolt projection, UL Listed for A-label applications. Standard latch faceplates 2 1/4" x 1 1/8" with square corners to accommodate beveled or flat front doors. 3/4" projection, UL Listed latch with 2 3/4" backset also available.

Strikes: 47/8" x 1 1/4" ANSI strike with curved lip to meet ANSI A115.2 standard door frame preparation standard. Consult Options and Accessories section for other strike sizes and configurations.

Screws: Furnished with combination wood/machine screws for use in wood or metal doors and frames.

ANSI/BHMA: Meets ANSI/BHMA A156.2, Series 4000, Grade 1.

UL: 3 hour A label.

X Series specifications

Key-in-knob cylindrical locksets shall be Falcon Lock X Series or equal and meet the following requirements:

- All locksets and latchsets shall meet Grade 1 requirements of ANSI/BHMA 156.2, Series 4000.
- Locksets and latchsets shall be UL Listed for use on 3 hour A label doors.
- Locksets and latchsets shall have 3 1/4" diameter round roses.
- Knobs shall be .050" minimum thickness. keyway standard on I/C core cylinders. Also available with other keyways and some competitor keyways. See pages 9-10.
- There shall be no exposed screws on trim.
- Locksets and latchsets shall have threaded collars for easy door thickness adjustment on both sides of lock.
- Cylinders shall have a minimum of 6 active pin chambers and shall be furnished with 2 nickel silver keys.
- Locksets shall have 6-pin (or 7-pin) interchangeable cores.

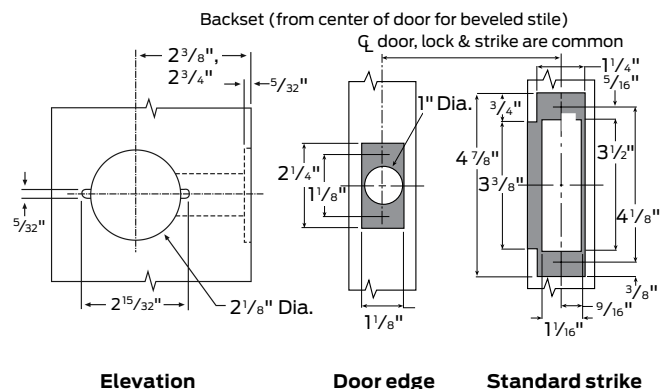

Knob designs

Knobs and roses

Knobs and roses are wrought brass, bronze or stainless steel (Troy) installed over steel or nonferrous reinforcing plates. Knobs are secured by a spring-loaded retainer. Retainer cannot be depressed when locks have been locked.

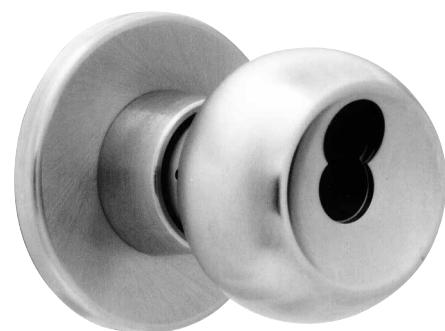
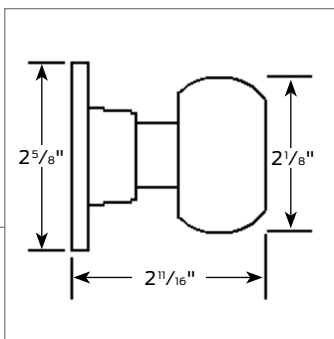

TG
Troy-Gala

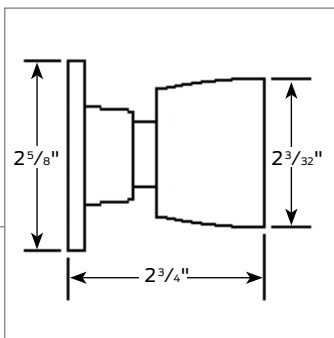

EG
Elite-Gala

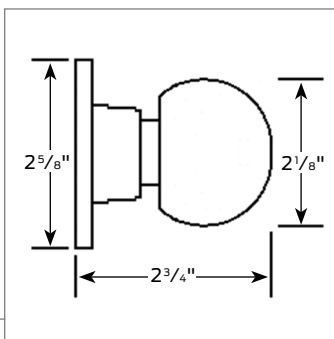
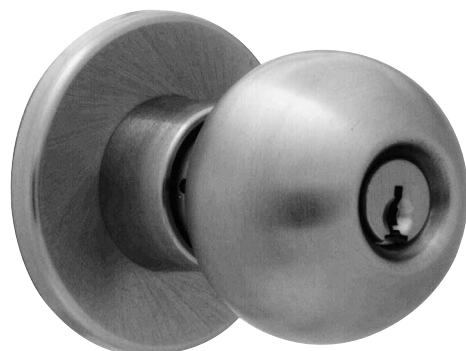

HG
Hana-Gala

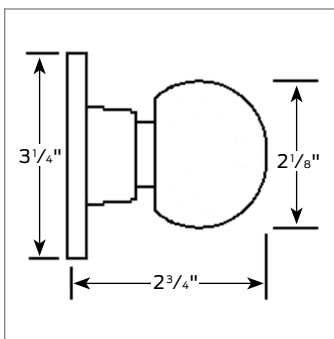

HY
Hana-York

Knob designs

(continued)

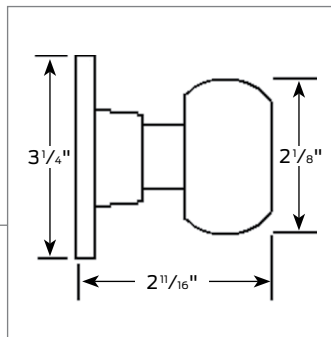

TY
Troy-York

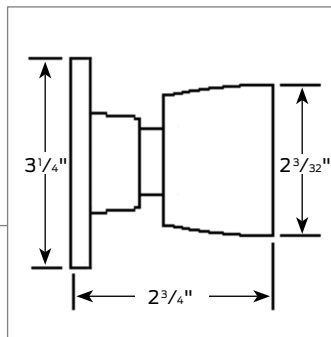

EY
Elite-York

Abrasive coated knobs

All trim is available with abrasive coating around the circumference of the knob to identify entrances to hazardous areas to the handicapped. To order, add: "with abrasive coated outer knob" in detail section of order.

Knurled knobs

All heavy duty knobs are available knurled to identify entrances to hazardous areas for the handicapped. To order add: "with knurled knob" (outer or inner) in detail section of order.

Functions

To order Falcon T Series locksets, please consult page 29 for ordering information and assistance.

 Indicates interchangeable core available.

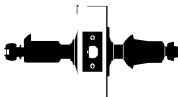
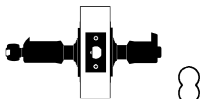
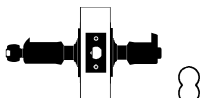
Catalog number	Function	Description	ANSI No. & Grade
X101		Passage/closet latchset—Latch bolt by knobs at all times.	F75-1
X301		Privacy lock—Latch bolt by knobs. Outside knob locked by push button in inside knob. Rotating inside knob or closing door releases push button. Emergency release in outside knob. Emergency Release Tool 001423-001-30.	F76-1
X411		Asylum lock—Deadlocking latch bolt by key from either side. Both knobs rigid.	F87-1
X501		Entry lock—Push button locking. Button on inside locks outside knob until unlocked by key or by rotating inside knob.	F82-1
X511		Entry/office lock—Turn/push button locking. Pushing and turning button locks outside knob requiring use of key until button is manually unlocked. Push button locking. Pushing button locks outside knob until unlocked by key or by turning inside knob.	F109-1
X521		Office lock—Turn button locking. Turning button locks outside knob requiring use of key until button is manually unlocked. Inside knob always free.	F81-1
X561		Classroom lock—Deadlocking latch bolt by knobs. Outside knob is locked by key in outside knob. Inside knob is always free.	F84-1
X571		Dormitory lock—Deadlocking latch bolt by knobs except when locked by push button in inside knob. Key in outside knob locks or unlocks outside knob and releases button. Closing door releases push button. Inside knob always free.	F90-1
X581		Storeroom lock—Deadlocking latch bolt by inside knob or key outside. Outside knob rigid.	F86-1
X12		Dummy trim—Single trim—surface mounted.	

Cylinders

Falcon interchangeable cores

Catalog number	Description
C606	For use in all X Series I/C keyed locks-6-pin (cover style)
C607	For use in all X Series I/C keyed locks-7-pin (cover style)
CB806	For use in all X Series I/C keyed locks-6-pin (cap style)
CB807	For use in all X Series I/C keyed locks-7-pin (cap style)

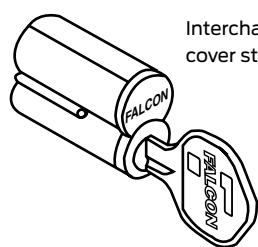

Interchangeable core cover style

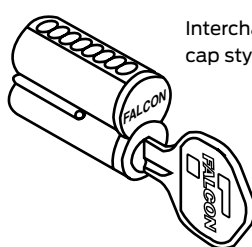

Interchangeable core cap style

Falcon standard cylinders

Catalog number	6-pin cylinder 5-pin cylinder	7-pin cylinder	Knob design	Function
A23151-00	A23161-00	N/A	E, T	561
A23152-00	A23162-00	N/A	E, T	411/501/511/521/581
A23151-02	A23161-02	N/A	E, T	571
A23151-02	A23161-02	A23171-01	H	561
A23152-02	A23162-02	A23172-02	H	411/501/511/521/581
A23151-03	A23161-03	A23171-02	H	571

Note: Specify finish: 606 or 626. Specify keyway: "E", "G" (standard), "H", "K", "L", "N" or "P".

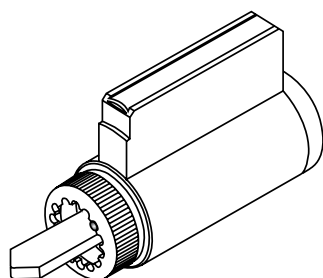

X381 outside
411, 501
511, 521, 581
Hana

Competitor keyways

Standard cylinders with competitor keyways — 6-pin

Functions: 561

Catalog no.	Description	Knob design
A23174-001	Corbin/Russwin L4 'O' bitted	E,T
A23167-001	Corbin 60 'O' bitted	E,T
A23167-1KD	Corbin 60 'KD' keyed different	E,T
A23168-001	Russwin D1 'O' bitted	E,T
A23168-1KD	Russwin D1 'KD' keyed different	E,T
A23166-001	Sargent LA 'O' bitted	E,T
A23166-1KD	Sargent LA 'KD' keyed different	E,T
A23160-001	Schlage C 'O' bitted	E,T
A23160-1KA	Schlage C 'KA' keyed alike 4	E,T
A23160-1KD	Schlage C 'KD' keyed different	E,T
A23159-001	Schlage E 'O' bitted	E,T
A23169-001	Yale 8 (PARA) 'O' bitted	E,T
A23169-1KD	Yale 8 (PARA) 'KD' keyed different	E,T

Note: Specify finish: 606 or 626.

Functions: 571

Catalog no.	Description	Knob design
A23167-004	Corbin 60 O-bitted	H
A23167-4KD	Corbin 60 KD	H
A23174-004	Corbin Russwin L4 O-bitted	H
A23168-004	Russwin D1 O-bitted	H
A23168-4KD	Russwin D1 KD	H
A23166-004	Sargent LA O-bitted	H
A23166-4KD	Sargent LA KD	H
A23160-004	Schlage C O-bitted	H
A23160-4KA	Schlage C KA4	H
A23160-4KD	Schlage C KD	H
A23159-004	Schlage E O-bitted	H
A23169-004	Yale 8 Para O-bitted	H
A23169-4KD	Yale 8 Para KD	H

Note: Specify finish: 606 or 626.

Functions: 411, 501, 511, 521 and 581

Catalog no.	Description	Knob design
A23174-005	Corbin/Russwin L4 'O' bitted	E,T
A23167-005	Corbin 60 'O' bitted	E,T
A23167-5KD	Corbin 60 'KD' keyed different	E,T
A23168-005	Russwin D1 'O' bitted	E,T
A23168-5KD	Russwin D1 'KD' keyed different	E,T
A23166-005	Sargent LA 'O' bitted	E,T
A23166-5KD	Sargent LA 'KD' keyed different	E,T
A23160-005	Schlage C 'O' bitted	E,T
A23160-5KA	Schlage C 'KA' keyed alike 4	E,T
A23160-5KD	Schlage C 'KD' keyed different	E,T
A23159-005	Schlage E 'O' bitted	E,T
A23169-005	Yale 8 (PARA) 'O' bitted	E,T
A23169-5KD	Yale 8 (PARA) 'KD' keyed different	E,T
A23174-006	Corbin/Russwin L4 'O' bitted	H
A23167-006	Corbin 60 'O' bitted	H
A23167-6KD	Corbin 60 'KD' keyed different	H
A23168-006	Russwin D1 'O' bitted	H
A23168-6KD	Russwin D1 'KD' keyed different	H
A23166-006	Sargent LA 'O' bitted	H
A23166-6KD	Sargent LA 'KD' keyed different	H
A23160-006	Schlage C 'O' bitted	H
A23160-6KA	Schlage C 'KA' keyed alike 4	H
A23160-6KD	Schlage C 'KD' keyed different	H
A23159-006	Schlage E 'O' bitted	H
A23169-006	Yale 8 (PARA) 'O' bitted	H
A23169-6KD	Yale 8 (PARA) 'KD' keyed different	H

Note: Specify finish: 606 or 626.

Functions: 561 Hana and X571 Troy & Elite

Catalog no.	Description	Knob design
A23174-003	Corbin/Russwin L4 'O' bitted	E,T, H
A23167-003	Corbin 60 'O' bitted	E,T, H
A23167-3KD	Corbin 60 'KD' keyed different	E,T, H
A23168-003	Russwin D1 'O' bitted	E,T, H
A23168-3KD	Russwin D1 'KD' keyed different	E,T, H
A23166-003	Sargent LA 'O' bitted	E,T, H
A23166-3KD	Sargent LA 'KD' keyed different	E,T, H
A23160-003	Schlage C 'O' bitted	E,T, H
A23160-3KA	Schlage C 'KA' keyed alike 4	E,T, H
A23160-3KD	Schlage C 'KD' keyed different	E,T, H
A23159-003	Schlage E 'O' bitted	E,T, H
A23169-003	Yale 8 (PARA) 'O' bitted	E,T, H
A23169-3KD	Yale 8 (PARA) 'KD' keyed different	E,T, H

Note: Specify finish: 606 or 626. Standard cylinders with competitor keyways - 7-Pin

Options and accessories

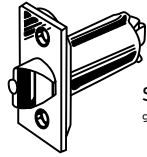

Square corner
9/16" projection

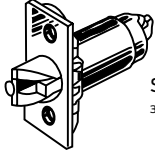

Square corner
3/4" projection

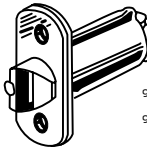

9/16" Radius corner
9/16" projection



3 Hour



Latches—Grade 1, UL listed

Catalog number	Description	Faceplate size	Corner	Projection
A98535-000	2 3/4" backset spring	2 1/4" x 1 1/8"	Square	9/16"
A98535-00D	2 3/4" backset deadlocking	2 1/4" x 1 1/8"	Square	9/16"
A98538-000	2 3/4" backset spring	2 1/4" x 1 1/8"	Radius 9/16"	9/16"
A98538-00D	2 3/4" Backset deadlocking	2 1/4" x 1 1/8"	Radius 9/16"	9/16"
A98835-OSD	2 3/4" Backset deadlocking	2 1/4" x 1 1/8"	Square	3/4"
A98838-OSD	2 3/4" Backset deadlocking	2 1/4" x 1 1/8"	Radius 9/16"	3/4"

Note: Specify finish 606, 612, 613, 630

Latches for X Series locks are UL listed. 2 3/4" backset standard.

1 1/8" width latch face minimum. Unless otherwise specified, we furnish a 2 1/4" x 1 1/8" x square corner faceplate on 2 3/4" backset latches front standard.

Latches—Grade 2, UL listed for flat or beveled doors

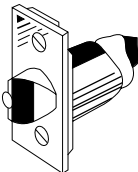

Square corner
1/2" projection

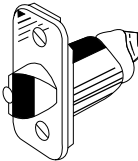

1/4" Radius corner
1/2" projection



3 Hour



Catalog number	Description	Faceplate size	Corner	Projection
A92320-000	2 3/8" backset spring	2 1/4" x 1"	Square	1/2"
A92320-00D	2 3/8" backset deadlocking	2 1/4" x 1"	Square	1/2"
A92321-000	2 3/8" backset spring	2 1/4" x 1"	Radius	1/2"
A92321-00D	2 3/8" backset deadlocking	2 1/4" x 1"	Radius	1/2"
A92330-000	2 3/4" backset spring	2 1/4" x 1"	Square	1/2"
A92330-00D	2 3/4" backset deadlocking	2 1/4" x 1"	Square	1/2"
A92331-000	2 3/4" backset spring	2 1/4" x 1"	Radius	1/2"
A92331-00D	2 3/4" backset deadlocking	2 1/4" x 1"	Radius	1/2"

Note: Specify finish 606, 612, 613, 630

Latches for X Series locks are UL Listed.

These grade 2 latches have self-adjusting fronts to accommodate beveled or flat front doors. Unless otherwise specified, we furnish a 2 1/4" x 1" x square corner faceplate on these latches.

Options and accessories

(continued)

Strikes

Furnished with a $4\frac{7}{8}$ " ANSI strike unless otherwise specified.

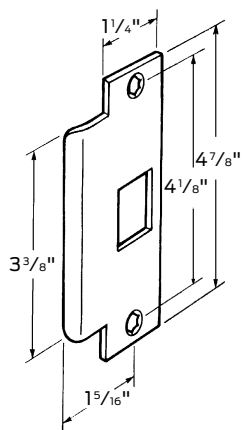

005164-000
ANSI prep A115.2

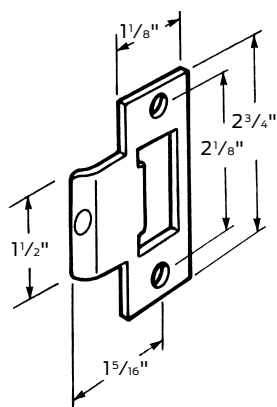

A05185-000
T-strike square corner

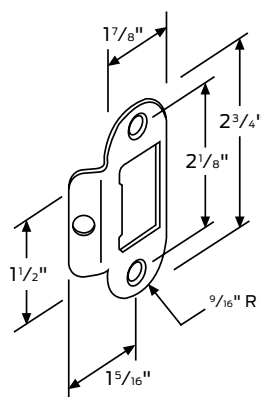

A05133-004
Vermin proof strike for ships

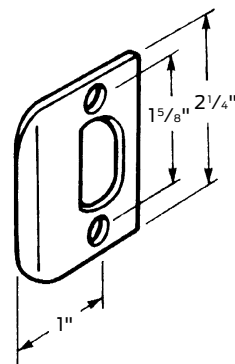

Q001-049
Full lip, square corner

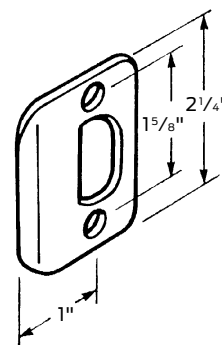

Q001-048
Full lip, $\frac{1}{4}$ " radius corner

Long backset extension link

A22161-005-00 Link for 5" backset for use with $2\frac{3}{4}$ " backset latches (except $\frac{3}{4}$ " projection).

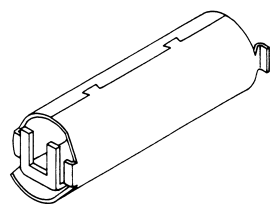

A22161-005-00

Dust boxes

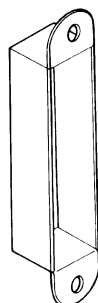

005099-000-30
1" deep. May be used with any $4\frac{7}{8}$ " high (ANSI) strike.

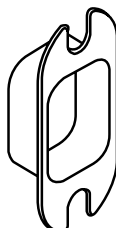

012191-003-70
 $\frac{1}{2}$ " deep. May be used with any $2\frac{3}{4}$ " high (T) strike.

Construction keying

Falcon offers two different construction key systems depending on the size of and application within the project. Both systems permit the installation and use of regular door locks during construction, yet completely preserve the security of the keying system for the ultimate building owner. The Master, Grand Master and change keys are never with the locks during the construction phase of a building. Only the “construction” keys are sent to the job site. Where the job permits, we will utilize the “Lost pin system” as our standard system for construction keying. Larger or more complicated jobs may require the use of our “Blockokey® System” for construction keying.

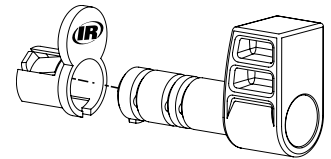

“Disposable construction” interchangeable cores

This newly designed disposable construction core (1408) is an inexpensive alternative to interior keyed construction cores. This core should be used on interior door applications or where security on a site is not a concern. No keys need to be issued. The disposable core is inserted in the lever or knob and is operated by a thumb turn, which retracts the latch bolt. Please use either brass or permanent construction cores on exterior doors or secured areas.

Locks with “Lost pin system”

Our “lost” pin construction key system consists of one construction pin and a shallow hole in the side of the plug.

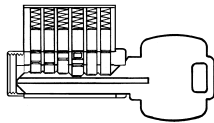

Construction key—KB566

When the “construction” key is used, the construction pin is always in the cylinder plug, sitting on top of the bottom pin. Consists of one construction pin and a shallow hole in the side of the plug.

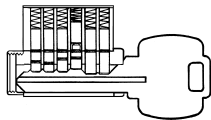

Master key—KB578

When the Master key is inserted, the construction pin is pushed up into the cylinder housing. As the Master key is rotated to the right, the construction pin will drop into the hole in the plug, thereby eliminating any future use of the construction key.

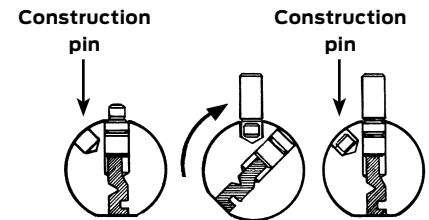

Locks with Blockokey® cylinders

All lock cylinders on a specific project are operable by a special “project key.” Duplicates of this key may be assigned by the building contractor to workmen and subcontractors as required. No regular change keys or Master keys are needed on the job. This eliminates the possibility of subsequent exposure from lost or stolen keys.

How to order locks with Blockokey® cylinders

Blockokey® locksets are ordered by adding the word “Blockokey” after the balance of the ordering information.

Example: 72 Each B511 D 626 1AA-72AA (Blockokey)

How locks with Blockokey® cylinders are used

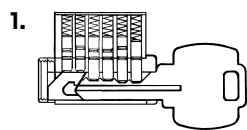

Project key—KB531

Lock cylinder is operated by the special “project key.” The last two pins in the cylinder are held inoperative by the key block.

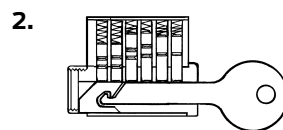

Removal tool—KB536

The special “project key” is canceled out by removal of the key block. A key block removal tool is furnished with the Master keys for the locks. Simply push the removal tool into the keyway, then withdraw it to remove the block. Thereafter, the “project key” will no longer operate the lock cylinder.

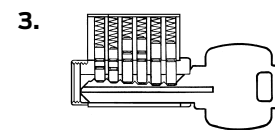

Change or master key—KB578

Cylinder is now only operable by the regular change key or Master key.

Conversion chart

X Series Grade 1 cylindrical key-in-lever lock

ANSI no./Grade	Function	Falcon	Arrow	Best	Corbin/Russwin	Marks	Sargent	Yale
F75-1	Passage	X101	H01	83KN	CK4210	80N	8U15	5401
F76-1	Privacy	X301	H02	83KL	CK4220	80L	8U65	5402
F87-1	Asylum	X411	H33	83KW	CK4232	80DW	8G17	5430
F82-1	Entry	X501	H13	83KAB	CK4261	—	8G24	5407
F109-1	Entry/office	X511	H11	83KAB	CK4251	80AB	8G24	5407
F81-1	Office	X521	H11	83KAB	CK4251	80A	8G05	5407
F84-1	Classroom	X561	H17	83KR	CK 4255	80S	8G37	5408
F90-1	Dormitory	X571	H19	83KT	CK4275	80T	8G54	5422
F86-1	Storeroom	X581	H12	83KD	CK4257	80F	8G04	5405
	Dummy—single	X12	H08	83K1DT	CK4250	80DO	8U93	455

Trim styles

Falcon	Arrow	Best	Corbin/Russwin	Marks	Sargent	Yale
Hana/Gala (HG)	BD	4C	GRC	280	OB	CA
Troy/Gala (TG)	TA	—	—	180	EC	LF
Elite/Gala (EG)	DD	6C	BRC	—	EG	BR

All effort has been made to make this information comprehensive. Since no two products are exactly alike, this data represents those products which are similar. This information was obtained from trade services and is not guaranteed nor meant to represent any product as equal to any other product.

How to order

For correct ordering, and to ensure no delays in shipment of your order, the following descriptive data must be listed in the sequence shown. Necessary information can be found in other parts of this catalog. The example below shows an order for 20 each X locksets in the 301 Privacy function, EG (Elite-Gala) trim design in a 626 (satin chrome) finish, with 2 3/4" backset latch, to accommodate doors 1 3/4" thick.

- **Quantity:** Indicate the quantity required.
- **Catalog number:** Select function number, cylinder type, and latch style from tables in this section.
- **Trim design:** Indicate letter of knob/rose design. EG = Elite/Gala; HY = Hana/York. Outside design always precedes inside design on split designs.
- **Finish:** When the finish is the same for the outside and inside trim, it is shown once (626). Outside finish always precedes inside finish on split finishes (605 x 625).
- **Latches:** 2 3/4" backset is standard. 2 3/8" backset available. All latches are UL listed 3-hour A label.
- **Strikes:** 4 7/8" x 1 1/4" ANSI standard. Optional T-strike or full lip strike available. See page 12.
- **Cylinder type:** 6-pin standard. For 7 pin add PD7 to product catalog numbers (eg. X511PD7 HAN). 7 pin conventional cylinders are available in Hana knob style only.
- **Door hand:** Locks are field reversible. Please specify handing on all keyed locks so that cylinders can be assembled in the upright position.
- **Keying detail:** We suggest using the standard terms developed by DHI (Door and Hardware Institute).
 - Example: AA1 - Grand Master keyed, Master keyed, change key 1.
- **Interchangeable core:** To order product capable of accepting an interchangeable core, add suffices from the keying table to the function number, preceding the latch style.
 - Example: X511HD will be supplied with SFIC keyed construction core.
- **Keyways:** "G" is standard on regular cylinders, "A" is standard on interchangeable cores. Other keyways available.
- **Additional keys:** Note the total number of keys required.
- **Large bow keys:** Add—"with large bow keys."

How to order example

Line item	Qty.	Product	Outside		Inside		Hand	Latch	Strike	Door thickness	Ext.	DIM	Additional details/keying
			Des	Fin	Des	Fin							
1	20	X301S	EG	626			LHR	98535	5185	1 3/4"			With 012191-003-70 dust box

Finishes

The latest in modern techniques and equipment are used to apply the highest quality finish. Extra steps assure durable, consistent finishes and long useful life.

Although we apply the finest available protective plating and/or enamel coating to the surface of our products, these finishes have limitations and in time may deteriorate either from exposure to weather, pollution, perspiration, extremes

of climate, frequency of use or other factors. Deterioration of these finishes is, therefore, not a defect, but a normal process which is unavoidable. Our company cannot accept responsibility for finish deterioration in these circumstances, and therefore the finishes cannot be guaranteed. These products will not be refinished or replaced under our warranty should deterioration of finishes occur.

Trim finishes chart

Description	ANSI No.	Available on
Bright brass	605	All trim
Satin brass	606	All trim
Satin bronze	612	All trim
Oil rubbed bronze	613	All trim
Bright chrome	625	All trim
Satin chrome	626	All trim
Satin stainless steel	630	Troy knobs only

B Series

Grade 2, medium-duty cylindrical lever locks

When you need a tough, reliable lock for a government/military, retail, industrial or multi-family project, you need a Falcon B Series lock. Our full line of Grade 2 locksets are a perfect replacement for existing locks, or a smart spec in new construction. With upgraded finishes these locks deliver style as well as strength. Falcon B Series locks feature an interchangeable core that can be removed for quick, easy re-keying, and are compatible with SFIC products from other manufacturers. Most important, they're backed by one of the best names in the business.

Features

Heavy wrought brass or bronze roses over steel through-bolted rose inserts

UL Listed 1 1/2 hour

Cylinder housings and plugs machined from solid brass

Brass or cold-formed steel construction with zinc dichromate plating for rust resistance



Cylindrical locks

Features

Door thickness: 1 3/8" to 2" standard.

Backset: 2 3/4" standard. 2 3/8" also available.

Mechanism: Parts constructed of brass or cold formed steel, zinc plated and dichromated for rust resistance. Springs are stainless steel.

Attachment: Lock chassis secured to door by two screws which pass through a steel rose insert inside and thread directly into the outer rose mounting assembly.

Handing: Locks are non-handed.

Cylinders: Drilled with 6-pin chambers, pinned in 5. Pinning in 6 chambers available when specified, at no cost. Cylinder assemblies removable to rekey. Also available with 6 or 7-pin interchangeable core cylinders. Cylinder housings and plugs machined from solid brass. Springs are phosphor bronze. Two nickel silver keys furnished standard.

Competitor cylinders: The B Series accepts these standard 6-pin cylinders: Assa, Kaba, Lori, Medeco, Primus and Schlage.

Keyways: "G" keyway standard on standard cylinders. "A" keyway standard on I/C core cylinders. Also available with some optional keyways. See page 9.

Trim: Roses are 3 1/2" diameter, heavy wrought brass or bronze, installed over steel rose inserts which are through-bolted through door. Levers are pressure cast zinc (solid levers no inserts) material finished to match mating parts.

Latches: 1/2" bolt projection. UL (3-hour, A Label) listed. Latches have self-adjusting fronts to accommodate beveled or flat doors. 2 3/8" backset with 2 1/4" x 1" latchfaces, 2 3/4" backset with 2 1/4" x 1 1/8" latchfaces. Deadlocking latches have a solid round bar stock DL bar preventing latch jamming and/or lock outs.

Strikes: 4 7/8" x 1 1/4" ANSI strike with curved lip to meet ANSI A115.2 door frame preparation standard. Consult Options and Accessories section for other available strike size and configurations.

Screws: Furnished with combination screws for use in wood or metal doors and frames.

ANSI/BHMA: Exceeds ANSI/BHMA A156.2, Series 4000, Grade 2.

UL: 3 hour, A label.

B Series specifications

Key-in-lever cylindrical locksets shall be Falcon B Series or equal and meet the following requirements:

- All locks shall meet the new ANSI/BHMA A156.2, Series 4000, Grade 2 test requirements for key-in-lever locksets.
- Locksets shall be UL Listed 3-hour, A Label.
- Lever trim shall have individual heavy-duty springs for lever return and to prevent lever sag. Trim shall be through-bolted with screws coated with thread sealant to provide strength and resistance to loosening.
- Roses shall be 3 1/2" diameter.
- All lever designs shall be solid (no inserts) and meet the federal ADA and state disability requirements.
- Locksets shall adjust to fit door thickness from 1 3/8" to 2".
- All locksets shall be non-handed and not require field disassembly for re-handing.
- Preparation for door must be non-handed. Acceptable manufacturer: Falcon lock

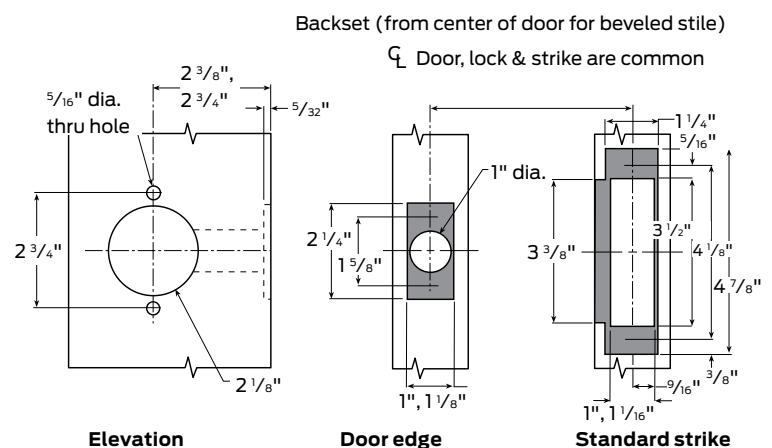

Lever designs

Levers

Levers are solid pressure cast zinc, finished to match mating parts. Roses are wrought brass or bronze installed over steel through-bolted rose inserts. Levers are secured by a spring-loaded retainer. Retainer in keyed lever cannot be depressed without key.



D
Dane

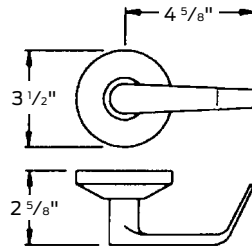

Q
Quantum

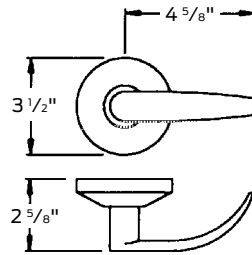















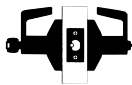

Abrasive strip levers

All levers are available with an abrasive strip along the inside length of the lever to identify entrances that may be hazardous to the handicapped. To order, change trim designation to: 6DA (Dane) or 6QU (Quantum) in trim section of order. Not available on 613 finish as abrasive strip will not hold.

Functions

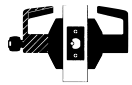
To order Falcon B Series locksets, please consult page 29 for ordering information and assistance.

 Indicates interchangeable core available.

Catalog number	Function	Description	ANSI number & grade
B101		Passage/closet latchset—Latch bolt by levers at all times.	F75-2
B161		Communicating/exit latch—Deadlocking latch bolt by inside lever. Non-removable blank plate outside.	
B301		Privacy lock—Latch bolt by levers. Outside lever locked by push button in inside lever. Rotating inside lever or closing door releases push button. Emergency release in outside lever unlocks door.	F76-2
B341	 	Connecting room/exit lock—Deadlocking latch bolt by inside lever except when locked by key. Non-removable blank plate outside ($2\frac{2}{32}$ " projection).	
B501	 	Entry lock—Push button locking. Button on inside locks outside lever until unlocked by key or by rotating inside lever. Inside lever always free. Deadlocking latch bolt.	F82-2
B511	 	Entry/office lock—Turn/push button locking. Pushing and turning button locks outside lever requiring use of key until button is manually unlocked. Push button locking. Pushing button locks outside lever until unlocked by key or by rotating inside lever. Inside lever always free. Deadlocking latch bolt.	F109-2
B561	 	Classroom lock—Deadlocking latch bolt by levers. Outside lever is locked by key in outside lever. Inside lever is always free.	F84-2
B581	 	Storeroom lock—Deadlocking latch bolt by lever inside or key outside. Outside lever is rigid. Inside lever is always free.	F86-2
B611	 	Assisted living lock—Deadlocking latch bolt by levers except when locked by push button on inside lever. Key in outside lever locks or unlocks outside lever and releases button. Closing door releases push button. Inside lever is always free.	
B12		Dummy trim—Single trim. Surface mounted rigid lever.	

Cylinders for competitor keyways

Falcon interchangeable cores

Catalog number	Description
C606	For use in all B Series I/C keyed locks (cover style)
C607	For use in all B Series I/C keyed locks (cover style)
CB806	For use in all B Series I/C keyed locks (cap style)
CB807	For use in all B Series I/C keyed locks (cap style)

Note: Specify finish: 606 or 626.

Specify keyway: "A" (standard) or other keyway.

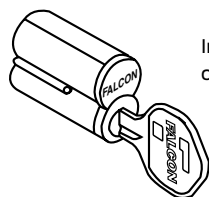

Interchangeable core cover style

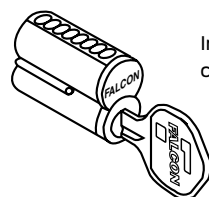

Interchangeable core cap style

Falcon standard cylinders

Catalog number	Description
A23155-02	5-pin* For use in all B Series except B611*
A23155-06	5-pin For use in all B Series except B611*
A23165-02	6-pin For use in all B Series except B611*
A23165-06	6-pin For use in all B Series except B611*

Note: Specify finish: 606 or 626.

Specify keyway: "E", "G" (standard), "H", "K", "L", "N", "P".

*B611 use same part number except -011, -11D and -11A

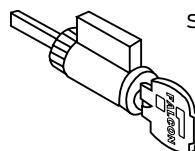

Standard cylinder

Standard cylinders with competitor keyways-6-pin

Catalog number	Description
A23167-013	Corbin 60 'O' bitted
A23167-13D	Corbin 60 'KD' keyed different
A23168-013	Russwin D1 'O' bitted
A23168-13D	Russwin D1 'KD' keyed different
A23174-013	Corbin Russwin L4 'O' bitted
A23174-13A	Corbin Russwin L4 'KA' keyed alike 4
A23166-013	Sargent LA 'O' bitted
A23166-13D	Sargent LA 'KD' keyed different
A23160-013	Schlage C 'O' bitted
A23160-13A	Schlage C 'KA' keyed alike 4
A23160-13D	Schlage C 'KD' keyed different
A23159-013	Schlage E 'O' bitted
A23169-013	Yale 8 (PARA) 'O' bitted
A23169-13D	Yale 8 (PARA) 'KD' keyed different

Note: Specify finish 606 or 626

For B611 use same part number except -011, -11A, -11D

Options and accessories

Latches—1/2" Projection, UL listed

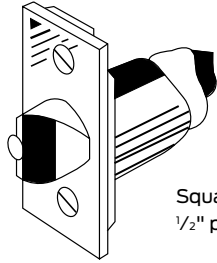

Square corner
1/2" projection

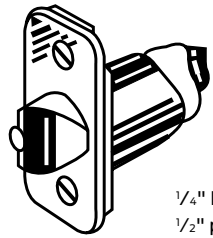

1/4" Radius corner
1/2" projection

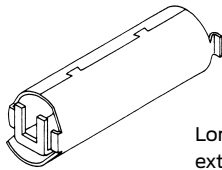

Long backset
extension link



1 1/2 Hour

Catalog number	Description (functions)	Faceplate size	Corner
A57420-000	2 3/8" Backset spring (101)	2 1/4" x 1"	Square
A57420-00D	2 3/8" Backset deadlocking	2 1/4" x 1"	Square
A57421-000	2 3/8" Backset spring (101)	2 1/4" x 1"	Radius
A57421-00D	2 3/8" Backset deadlocking	2 1/4" x 1"	Radius
A57425-000	2 3/8" Backset spring (101)	2 1/4" x 1 1/8"	Square
A57425-00D	2 3/8" Backset deadlocking	2 1/4" x 1 1/8"	Square
A57620-000	2 3/8" Backset spring (301)	2 1/4" x 1"	Square
A57620-00D	2 3/8" Backset deadlocking (611)	2 1/4" x 1"	Square
A57621-000	2 3/8" Backset spring (301)	2 1/4" x 1"	Radius
A57621-00D	2 3/8" Backset deadlocking (611)	2 1/4" x 1"	Radius
A57625-000	2 3/8" Backset spring (301)	2 1/4" x 1 1/8"	Square
A57625-00D	2 3/8" Backset deadlocking (611)	2 1/4" x 1 1/8"	Square
A57430-000	2 3/4" Backset spring (101)	2 1/4" x 1"	Square
A57430-00D	2 3/4" Backset deadlocking	2 1/4" x 1"	Square
A57431-000	2 3/4" Backset spring (101)	2 1/4" x 1"	Radius
A57431-00D	2 3/4" Backset deadlocking	2 1/4" x 1"	Radius
A57435-000	2 3/4" Backset spring (101)	2 1/4" x 1 1/8"	Square
A57435-00D	2 3/4" Backset deadlocking	2 1/4" x 1 1/8"	Square
A57630-000	2 3/4" Backset spring (301)	2 1/4" x 1"	Square
A57630-00D	2 3/4" Backset deadlocking (611)	2 1/4" x 1"	Square
A57631-000	2 3/4" Backset spring (301)	2 1/4" x 1"	Radius
A57631-00D	2 3/4" Backset deadlocking (611)	2 1/4" x 1"	Radius
A57635-000	2 3/4" Backset spring (301)	2 1/4" x 1 1/8"	Square
A57635-00D	2 3/4" Backset deadlocking (611)	2 1/4" x 1 1/8"	Square

Note: Specify finish: 605, 612, 613 or 630.

Latches for B Series locks are UL listed.

2 3/4" backset standard. 2 3/8" optional.

Unless otherwise specified, we furnish a 2 1/4" x 1" x square corner faceplate on 2 3/8" backset latches and 2 1/4" x 1 1/8" x square corner on 2 3/4" backset latches.

A31727-005-00 link for 5" backset. For use with 2 3/8" backset latches.

Options and accessories

(continued)

Strikes

Normally furnished with a 4 7/8" ANSI strike unless specified otherwise.

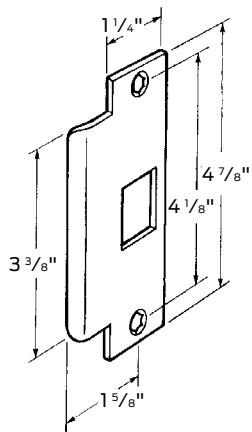

005164-000
ANSI Prep A115.2

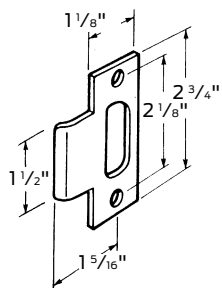

Q001-046
T-strike square corner

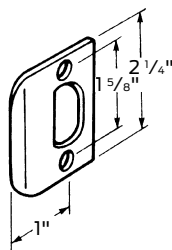

Q001-049
Full lip, square corner

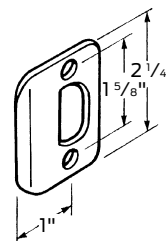

Q001-048
Full lip, 1/4" radius corner

*Specify finish: 605, 606, 612, 613, 626 or 630.

Dust boxes

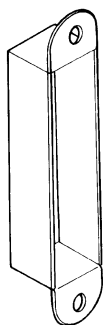

K510-066-PLA (EC 3604)
1" deep. May be used with any
4 7/8" high (ANSI) strike.

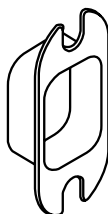

012191-003-70
1/2" deep. May be used with
any 2 3/4" high (T) strike.

Construction keying

Falcon offers two different construction key systems depending on the size of and application within the project. Both systems permit the installation and use of regular door locks during construction, yet completely preserve the security of the keying system for the ultimate building owner. The Master, Grand Master and change keys are never with the locks during the construction phase of a building. Only the “construction” keys are sent to the job site. Where the job permits, we will utilize the “Lost pin system” as our standard system for construction keying. Larger or more complicated jobs may require the use of our “Blockokey® System” for construction keying.

“Disposable construction” interchangeable cores

This newly designed disposable construction core (1408) is an inexpensive alternative to interior keyed construction cores. This core should be used on interior door applications or where security on a site is not a concern. No keys need to be issued. The disposable core is inserted in the lever or knob and is operated by a thumb turn, which retracts the latch bolt. Please use either brass or permanent construction cores on exterior doors or secured areas.

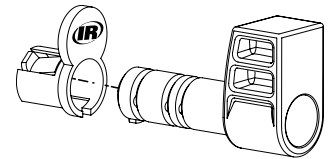

Locks with “Lost pin system”

Our “lost” pin construction key system consists of one construction pin and a shallow hole in the side of the plug.

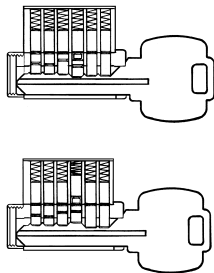

Construction key—KB566

When the “construction” key is used, the construction pin is always in the cylinder plug, sitting on top of the bottom pin.

Master key—KB578

When the Master key is inserted, the construction pin is pushed up into the cylinder housing. As the Master key is rotated to the right, the construction pin will drop into the hole in the plug, thereby eliminating any future use of the construction key.

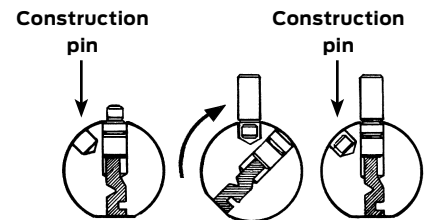

Locks with Blockokey® cylinders

All lock cylinders on a specific project are operable by a special “project key.” Duplicates of this key may be assigned by the building contractor to workmen and subcontractors as required. No regular change keys or Master keys are needed on the job. This eliminates the possibility of subsequent exposure from lost or stolen keys.

How to order locks with Blockokey® cylinders

Blockokey® locksets are ordered by adding the word “Blockokey” after the balance of the ordering information.

Example: 72 Each B511 D 626 1AA-72AA (Blockokey)

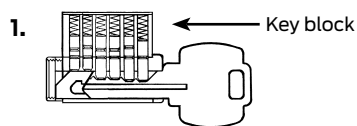

MProject key—KB531

Lock cylinder is operated by the special “project key.” The last two pins in the cylinder are held inoperative by the key block.

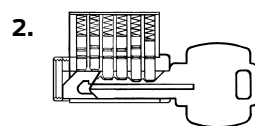

MProject Key—KB531

The special “project key” is canceled out by removal of the key block. A key block removal tool is furnished with the Master keys for the locks. Simply push the removal tool into the keyway, then withdraw it to remove the block. Thereafter, the “project key” will no longer operate the lock cylinder.

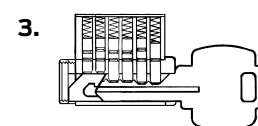

Change or master key—KB578

Cylinder is now only operable by the regular change key or Master key.

Conversion chart

B Series grade 2 cylindrical key-in-lever

ANSI number/grade	Function	Falcon	Arrow	Best	Corbin/Russwin	Marks	Sargent	Yale
F75-2	Passage	B101	M01	73KN	CL3910	N	65U15	5301LN
F76-2	Privacy	B301	M02	73KL	CL3920	L	65U65	5302LN
	Connecting/exit	B341	—	—	CL3981	SB	—	—
F82-2	Entry	B501	M13	—	—	—	—	—
F109-2	Entry/office	B511	M11	73KA	CL3951	AB	65G05	5307LN
F84-2	Classroom	B561	M17	73KR	CL3955	S	65G37	5308LN
F86-2	Storeroom	B581	M12	73KD	CL3957	F	65G04	5305LN
	Assisted living	B611	—	—	CL3975	—	—	—
	Dummy—single	B12	M08	1DT	CL3950	DO	65U93	—

Trim styles

Falcon	Arrow	Best	Corbin/Russwin	Marks	Sargent	Yale
Dane	SR	15C	NZD	170/170R	KL	CA
Quantum	BRR	—	PZD	270/270R	KP	PB

All effort has been made to make this information comprehensive. Since no two products are exactly alike, this data represents those products which are similar. This information was obtained from trade services and is not guaranteed nor meant to represent any product as equal to any other product.

How to order

For correct ordering, and to ensure no delays in shipment of your order, the following descriptive data must be listed in the sequence shown. Necessary information can be found in other parts of this catalog. The example below shows an order for 12 each B locksets in the 301 Privacy function, D (Dane) trim design in 626 (satin chrome) finish, with 2 3/4" backset latch, to accommodate doors 1 3/4" thick.

- **Quantity:** Indicate the quantity required.
- **Catalog number:** Select catalog number.
- **Trim design:** Indicate letter of lever design.
 - Example: D=Dane; Q=Quantum.
- **Finish:** When the finish is the same for the outside and inside trim, it is shown once (626). For split finishes, the outside is designated first, then the inside (605 x 625).
- **Latches:** 2 3/4" backset standard. 2 3/8" backset available. All latches are UL Listed 1 1/2 hour B Label.
- **Strikes:** 4 7/8" X 1 1/4" ANSI standard. Optional T-strike or full lip strike available. See page 7.
- **Cylinder type:** For 6-pin, add 6-pin.
- **Keying detail:** We suggest using the standard terms developed by A.H.C. (Architectural Hardware Consultants).
 - Example: AA1 - Grand master keyed, master keyed, change key 1.
- **Interchangeable core:** To order product capable of accepting an interchangeable core, add "FIC" (for interchangeable core). To order product with an interchangeable core, add "WIC" (with interchangeable core).
- **Keyways:** "G" is standard on regular cylinders, "A" is standard on interchangeable cores. Other keyways available. See page 7.
- **Additional keys:** Note the total number of keys required. Large bow keys: Add—"with large bow keys."

How to order example

Qty.	Catalog number	Trim design	Finish	Latch	Strike	Cylinder	Detail
12	B301S	Dan	626	Std	Std	-	2 3/4" backset - 1 3/4" door

Finishes

The latest in modern techniques and equipment are used to apply the highest quality finish. Extra steps assure durable, consistent finishes and long useful life.

Although we apply the finest available protective plating and/or enamel coating to the surface of our products, these finishes have limitations and in time may deteriorate either from exposure to weather, pollution, perspiration, extremes

of climate, frequency of use or other factors. Deterioration of these finishes is, therefore, not a defect, but a normal process which is unavoidable. Our company cannot accept responsibility for finish deterioration in these circumstances and therefore the finishes cannot be guaranteed. These products will not be refinished or replaced under our warranty should deterioration of finishes occur.

Trim finishes chart

Description	ANSI No.	Available on
Bright brass	605	All trim
Satin brass	606	All trim
Satin bronze	612	All trim
Oil rubbed bronze	613	All trim
Bright chrome	625	All trim
Satin chrome	626	All trim

W Series

Grade 2, medium-duty cylindrical lever and knob locks

Whether your application is government/military, retail, industrial or multi-family, there's a W Series lock that fits perfectly. In two popular lever and two popular knob styles Falcon can match most commercial door trim. The Falcon W Series locks feature conventional cylinders and small format interchangeable cores that are compatible with SFIC products from other manufacturers. Our conventional cylinders are available in all Falcon conventional key sections as well as Schlage C keyway, which we now masterkey across the complete Falcon product line. If quality product at a value price is what you are looking for, the Falcon W Series is the lock for you. And they're backed by one of the best names in the business, Allegion.

Features

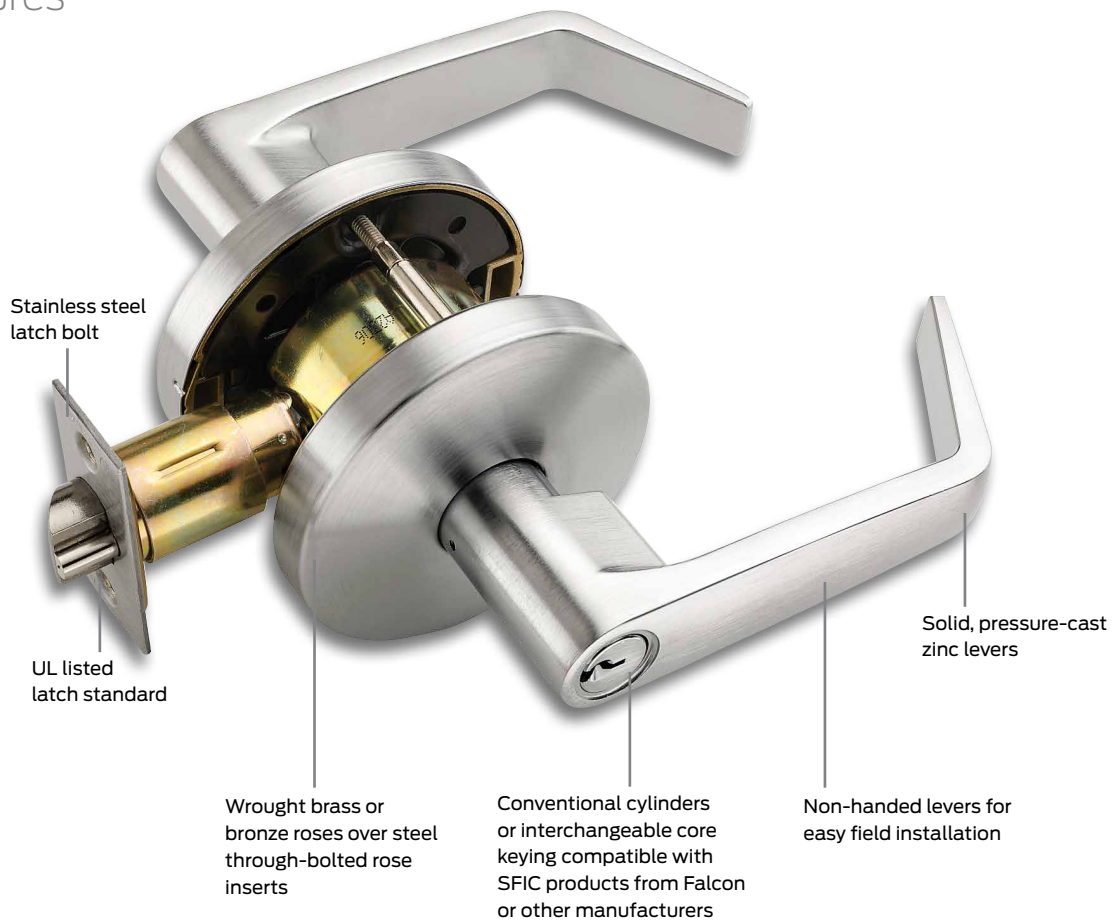

Cylindrical lever and knob locks

Features and specifications

W Series standard rose

Door thickness: 1³/₈" to 1³/₄" standard.

Backset: 2³/₄" standard; 2³/₈" also available.

Mechanism: Parts constructed of brass or cold-formed steel, zinc plated and dichromated for rust resistance. Springs are stainless steel.

Attachment: Lock chassis secured to door by two screws which pass through a steel rose insert inside and thread directly into the outer rose-mounting assembly, and two screws that screw into the chassis assembly.

Handing: Locks are non-handed.

Cylinder: Pinning in six chambers. Cylinder assemblies removable to re-key. Also available with 6- or 7-pin interchangeable core cylinders. Cylinder housings and plugs machined from solid brass. Springs are stainless steel. Two nickel silver keys furnished standard.

Competitor cylinder: The W Series accepts standard 6-pin cylinders available from Falcon, as well as Schlage, Corbin-Russwin, Yale and Sargent.

Keyways: "G" keyway standard on Falcon standard cylinders. "A" keyway standard on I/C core cylinders. Also available with some optional keyways. Schlage "C" keyway also available on standard cylinders, includes master key. Master keying available on all Falcon and Schlage "C" keyways.

Trim: Roses are heavy wrought brass or bronze, installed over steel rose inserts which are through-bolted through door. Levers are pressure-cast zinc (solid levers-no-inserts) finished to match mating parts.

Latches: 1/2" bolt projection made of stainless steel and UL listed for 3-hour door assemblies. Latches have self-adjusting fronts to accommodate beveled or flat doors. 2³/₈" backset with 1" x 2¹/₄" latch faces or 2³/₄" backset with 1¹/₈" x 2¹/₄" latch faces.

Strikes: 4⁷/₈" x 1¹/₄" ANSI strike with curved lip to meet ANSI A115.2 door frame preparation standard. Consult Options and Accessories section for other available strikes, sizes and configurations.

Screws: Furnished with combination screws for use in wood or metal doors and frames.

ANSI/BHMA: Meets ANSI/BHMA A156.2, Series 4000, Grade 2.

UL: 3-hour A label.

W Series small rose

Door thickness: 1³/₈" to 1³/₄" standard.

Backset: 2³/₈", 2³/₄" standard.

Mechanism: Parts constructed of brass or cold-formed steel, zinc plated and dichromated for rust resistance. Springs are stainless steel.

Attachment: Lock chassis secured to door by two screws which pass through a steel rose insert inside and thread directly into the outer rose-mounting assembly, and two screws that screw into the chassis assembly.

Handing: Locks are non-handed.

Cylinder: Pinning in six chambers. Cylinder assemblies removable to re-key. Also available with 6- or 7-pin interchangeable core cylinders. Cylinder housings and plugs machined from solid brass. Springs are stainless steel. Two nickel silver keys furnished standard.

Competitor cylinder: The W Series accepts standard 6-pin cylinders available from Falcon, as well as Schlage, Corbin-Russwin, Yale and Sargent.

Keyways: "G" keyway standard on Falcon standard cylinders. "A" keyway standard on I/C core cylinders. Also available with some optional keyways. Schlage "C" keyway also available on standard cylinders, includes master key. Master keying available on all Falcon and Schlage "C" keyways.

Trim: Roses are heavy wrought brass or bronze, installed over steel rose inserts which are through-bolted through door. Levers are pressure-cast zinc (solid levers-no-inserts) finished to match mating parts.

Latches: 1/2" bolt projection made of stainless steel and UL listed for 3-hour door assemblies. Latches have self-adjusting fronts to accommodate beveled or flat doors. 2³/₄" backset with 1¹/₈" x 2¹/₄" latch faces.

Strikes: 4⁷/₈" x 1¹/₄" ANSI strike with curved lip to meet ANSI A115.2 door frame preparation standard. Consult Options and Accessories section for other available strikes, sizes and configurations.

Screws: Furnished with combination screws for use in wood or metal doors and frames.

ANSI/BHMA: Meets ANSI/BHMA A156.2, Series 4000, Grade 2.

UL: 3-hour A label.

Cylindrical lever and knob locks

Features and specifications (continued)

W Series specifications

Key-in-lever cylindrical locksets shall be Falcon W Series or equal and meet the following requirements:

- All locks shall meet ANSI/BHMA A156.2, Series 4000, Grade 2 test requirements for key-in-lever locksets.
- Locksets shall be UL Listed 3-hour, A Label.
- Lever trim shall have individual heavy-duty springs for lever return and to prevent lever sag. Trim shall be through-bolted.
- All lever designs shall be solid (no inserts) and meet the federal ADA and state disability requirements.
- Locksets shall adjust to fit door thickness from $1\frac{3}{8}$ " to $1\frac{3}{4}$ ".
- All locksets shall be non-handed and not require field disassembly for re-handing.
- Preparation for door must be non-handed. Acceptable manufacturer: Falcon lock

Door templating

W Series standard rose

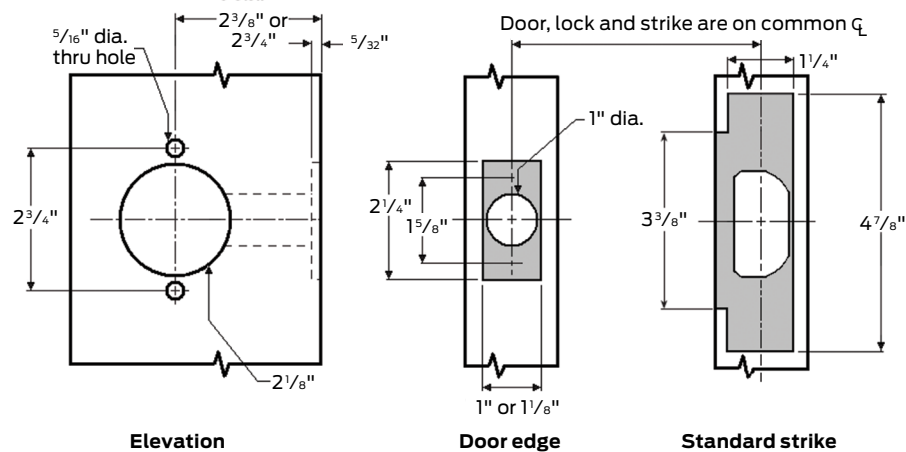

W Series small rose

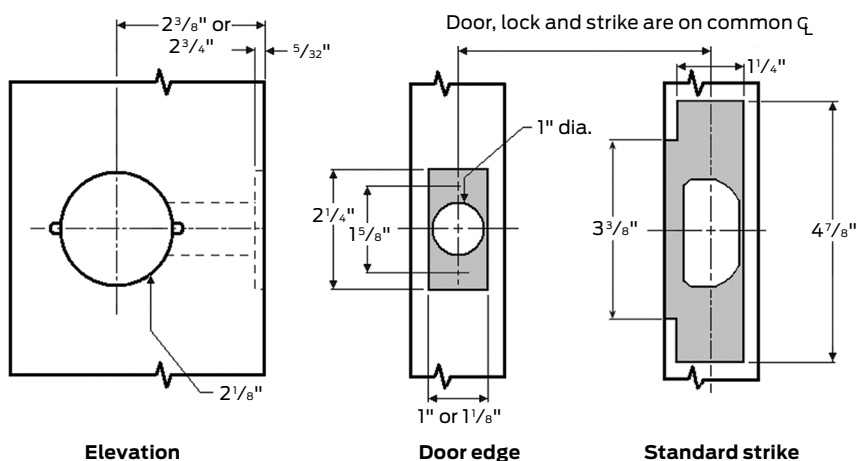

Lever designs

Levers

Levers are solid pressure cast zinc, finished to match mating parts. Roses are wrought brass or bronze installed over steel through-bolted rose inserts. A spring-loaded retainer secures levers. Secure side retainer cannot be depressed without a key that operates the lock.



**W Series
standard rose**
Dane lever shown
actual size



**W Series
small rose**
Dane lever shown
actual size

Standard rose

Dane

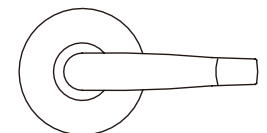
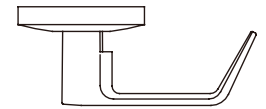

Quantum

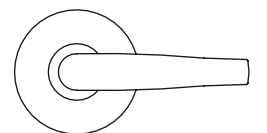
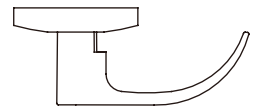

Small rose

Dane

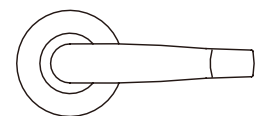
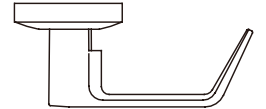

Quantum

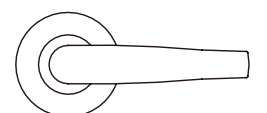





Abrasive lever options

All levers are available with an abrasive strip along the length of the lever to identify entrances to areas hazardous to the disabled. To order add 6 (for example, 6DA for Dane lever or 6QU for Quantum lever) to the order number.

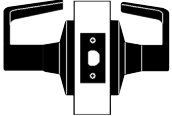
Functions

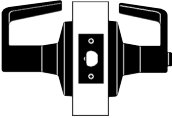
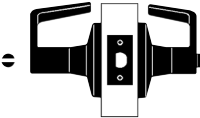
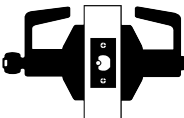
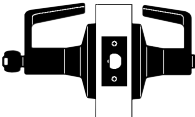
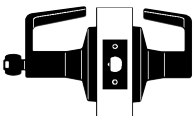
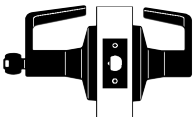
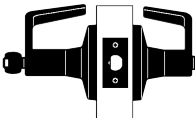
Levers

Catalog number	Description	ANSI number/grade
*W101	 <p>Passage latchset—Latch bolt by levers at all times.</p>	F75
*W161	 <p>Communicating/exit latch—Deadlocking latch bolt by inside lever. Non-removable blank plate outside. Inside lever is always free.</p>	
W201	 <p>Patio lock—Deadlocking latch bolt by levers. Outside lever is locked by push button from inside. Rotating inside lever or closing door releases button and unlocks outside lever.</p>	F77
*W301	 <p>Privacy lock—Latch bolt by levers. Outside lever is locked by push button on inside lever. Rotating inside lever or closing door releases push button and frees outside lever. Inside lever is always free. Emergency release in outside lever unlocks door.</p>	F76
W501	 <p>Entry lock—Push button locking. Button on inside locks outside lever until unlocked by key or by rotating inside lever. Closing door release push button and unlocks door. Inside lever always free. Deadlock latchbolt.</p>	F82
*W511	 <p>Entry/office lock—Deadlocking latch bolt by levers. Turn/push button locking. Pushing and turning button locks outside lever, requiring use of a key for unlocking the door until button is manually unlocked. Pushing button locks outside lever until unlocked by key or by rotating inside lever. Inside lever is always free.</p>	F109
*W561	 <p>Classroom lock—Deadlocking latch bolt by levers. Outside lever is locked by key in outside lever. Inside lever is always free.</p>	F84
*W581	 <p>Storeroom lock—Deadlocking latch bolt by lever inside or key outside. Outside lever is always locked. Inside lever is always free.</p>	F86
W711	 <p>Apartment entrance lock—Deadlocking latch bolt by levers. Turn/push button locking. Pushing and turning button locks outside lever, requiring use of a key for unlocking the door until button is manually unlocked. Pushing button locks outside lever until unlocked by key, by rotating inside lever, or by closing the door. Inside lever is always free.</p>	
*W12	 <p>Single dummy trim—Single trim, surface-mounted rigid lever.</p>	

*Available as small rose

Knob designs

Knobs are constructed of brass or cold-formed steel and are zinc-plated and dichromated for rust resistance. Springs are stainless steel. Roses are heavy-wrought brass or bronze, installed over wrought steel reinforcing plates. Knobs are brass or bronze, secured by a steel knob retainer, which cannot be depressed when lock has been locked.



Cointurn
Elite shown



Cylinder
Elite shown



Interchangeable core
Elite shown



Plain
Hana shown



Pushbutton (interior)
Hana shown



Thumbturn (interior)
Hana shown

Elite

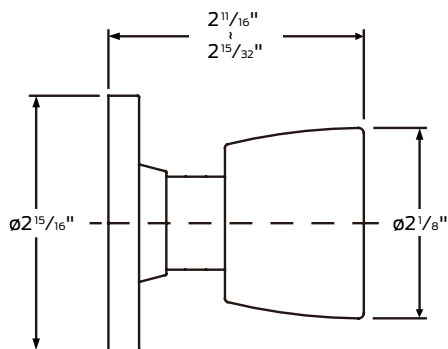

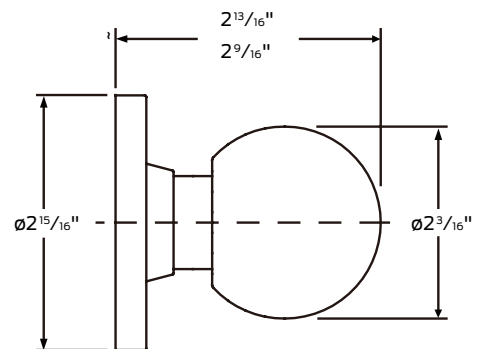

Hana

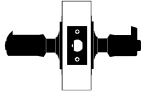
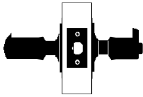
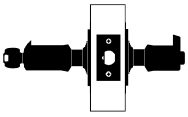
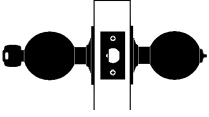
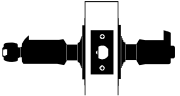
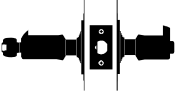
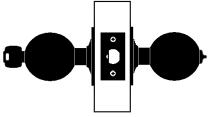

Functions

Knobs

Catalog number	Description	ANSI number/grade
W101	 <p>Passage latchset—Latch bolt by knob at all times.</p>	F75
W301	 <p>Privacy lock—Latch bolt by knobs. Outside knob is locked by push button on inside knob. Rotating inside knob or closing door releases push button and frees outside knob. Inside knob is always free. Emergency release in outside knob unlocks door.</p>	F76
W501	 <p>Entry lock—Push button locking. Button on inside locks outside knob until unlocked by key or by rotating inside knob.</p>	F82
W511	 <p>Entry/office lock—Deadlocking latch bolt by knobs. Turn/push button locking. Pushing and turning button locks outside knob, requiring use of a key for unlocking the door until the button is manually unlocked. Pushing button locks outside knob until unlocked by key or by rotating inside knob. Inside knob is always free.</p>	F109
W561	 <p>Classroom lock—Deadlocking latch bolt by knobs. Outside knob is locked by key in outside knob. Inside knob is always free.</p>	F84
W581	 <p>Storeroom lock—Deadlocking latch bolt by knobs. Outside knob is always locked. Inside knob is always free.</p>	F86
W711	 <p>Apartment entrance lock—Deadlocking latch bolt by knobs. Turn/push button locking. Pushing and turning button locks outside knob, requiring use of a key for unlocking the door until the button is manually unlocked. Pushing button locks outside knob until unlocked by key, by rotating inside knob, or by closing the door. Inside knob is always free.</p>	
W12	 <p>Single dummy trim—Single trim, surface-mounted rigid knob.</p>	

Cylinders

Falcon standard cylinders - 6-pin

Catalog number	Description
Q330-154	Falcon (specify keyway)
Q330-155	Falcon (for W561)

Note: Specify finish: 606 or 626
Specify keyway: G (standard), H, K, L, N, P

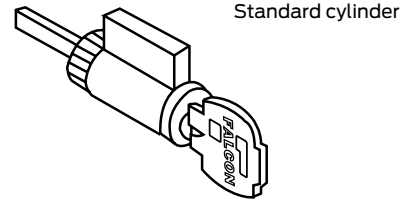

Standard cylinder

Falcon interchangeable core

Catalog number	Description
C606 (6-pin), C607 (7-pin)	For use in all I/C keyed locks (cover style)
CB806 (6-pin), CB807 (7-pin)	For use in all I/C keyed locks (cap style)

Note: Specify finish: 606 or 626
Specify keyway: A (standard) or other keyway

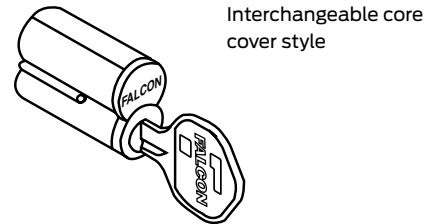

Interchangeable core cover style

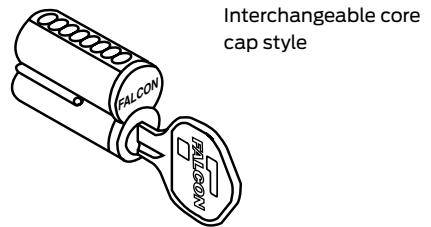

Interchangeable core cap style

Standard cylinders with other keyways - 6-pin

Catalog number	Description
Q330-152	Schlage C
Q330-153	Schlage C for W561
Q330-166	Corbin 60 (0 bit or KD only)
Q330-167	Corbin 60 (0 or KD only) for W561
Q330-210	Russwin D1 (0 bit or KD only)
Q330-211	Russwin D1 (0 bit or KD only) for W561
Q330-158	Cor/Russ L4 (0 bit or KD only)
Q330-159	Cor/Russ L4 (0 bit or KD only) for W561
Q330-160	Sargent LA (0 bit or KD only)
Q330-161	Sargent LA (0 bit or KD only) for W561
Q330-164	Tailpiece for Q330-154 Falcon and Schlage cylinders (All other functions)
Q330-165	Tailpiece for Q330-155 Falcon and Schlage cylinders (W 561 function only)
Q330-168	Tailpiece for SFIC (All functions)
Q330-156	Yale 8 (0 bit or KD only)
Q330-169	Tailpiece for W Lock knobs — SFIC

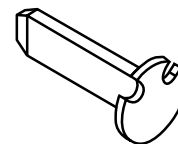

Q330-164
Conventional cylinder tailpiece

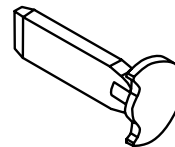

Q330-165
Conventional cylinder tailpiece W561

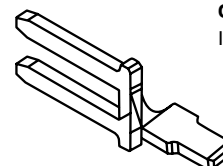

Q330-168
IC core tailpiece

Options and accessories

Latches and strikes

Latches

1/2" Projection, UL listed, stainless steel bolt

- Latches for W Series locks are 3-hour UL listed.
- 2 3/4" backset standard.
- 2 3/8" backset optional.
- Unless otherwise specified we furnish a 1" x 2 1/4" square corner faceplate on 2 3/8" backset latches, and a 1 1/8" x 2 1/4" square corner faceplate on 2 3/4" backset latches.

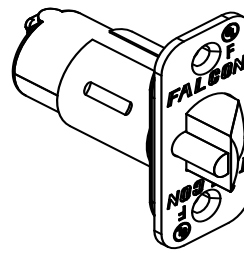

1/4" Radius corner
1/2" Projection

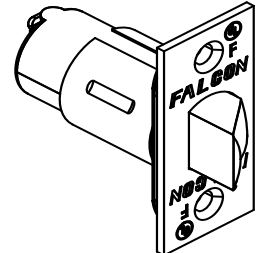

Square corner
1/2" Projection

Catalog number	Description (functions)	Faceplate size	Corner
Q330-192	2 3/4" backset dead locking (201, 711, 501)	1" x 2 1/4"	Square
Q330-193	2 3/4" backset dead locking (201, 711, 501)	1" x 2 1/4"	Radius
Q330-194	2 3/4" backset dead locking (201, 711, 501)	1 1/8" x 2 1/4"	Square
Q330-195	2 3/4" backset dead locking	1" x 2 1/4"	Square
Q330-196	2 3/4" backset dead locking	1" x 2 1/4"	Radius
*Q330-197	2 3/4" backset dead locking	1 1/8" x 2 1/4"	Square
Q330-198	2 3/8" backset dead locking (201, 711, 501)	1" x 2 1/4"	Square
Q330-199	2 3/8" backset dead locking (201, 711, 501)	1" x 2 1/4"	Radius
*Q330-200	2 3/8" backset dead locking (201, 711, 501)	1 1/8" x 2 1/4"	Square
Q330-201	2 3/8" backset dead locking	1" x 2 1/4"	Square
Q330-202	2 3/8" backset dead locking	1" x 2 1/4"	Radius
*Q330-203	2 3/8" backset dead locking	1 1/8" x 2 1/4"	Square
Q330-204	2 3/4" backset spring latch	1" x 2 1/4"	Square
Q330-205	2 3/4" backset spring latch	1" x 2 1/4"	Radius
*Q330-206	2 3/4" backset spring latch	1 1/8" x 2 1/4"	Square
Q330-207	2 3/8" backset spring latch	1" x 2 1/4"	Square
Q330-208	2 3/8" backset spring latch	1" x 2 1/4"	Radius
*Q330-209	2 3/8" backset spring latch	1 1/8" x 2 1/4"	Square

*Available as small rose

Strikes

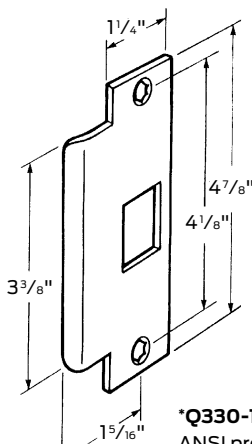

*Q330-148
ANSI prep
A115.2

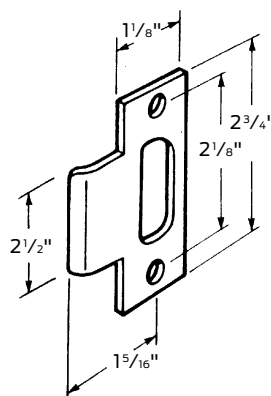

*Q330-149
T-strike
square corner

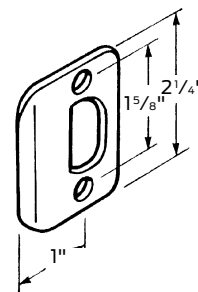

Q330-150
Full lip, 1/4"
radius corner

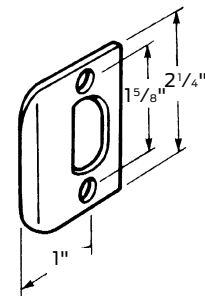

Q330-151
Full lip,
square corner

*Available as small rose

Construction keying

Falcon offers two different construction key systems depending on the size of and application within the project. Both systems permit the installation and use of regular door locks during construction, yet completely preserve the security of the keying system for the ultimate building owner. The Master, Grand Master and change keys are never with the locks during the construction phase of a building. Only the “construction” keys are sent to the job site. Where the job permits, we will utilize the “Lost pin system” as our standard system for construction keying. Larger or more complicated jobs may require the use of our “Blockokey® System” for construction keying.

“Disposable construction” interchangeable cores

This newly designed disposable construction core (1408) is an inexpensive alternative to interior keyed construction cores. This core should be used on interior door applications or where security on a site is not a concern. No keys need to be issued. The disposable core is inserted in the lever or knob and is operated by a thumb turn, which retracts the latch bolt. Please use either brass or permanent construction cores on exterior doors or secured areas.

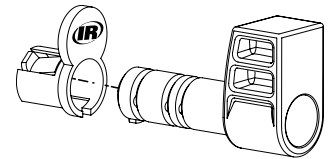

Locks with “Lost pin system”

Our “lost” pin construction key system consists of one construction pin and a shallow hole in the side of the plug.

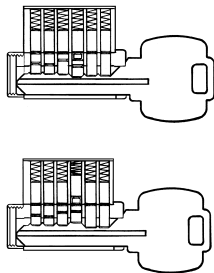

Construction key—KB566

When the “construction” key is used, the construction pin is always in the cylinder plug, sitting on top of the bottom pin.

Master key—KB578

When the Master key is inserted, the construction pin is pushed up into the cylinder housing. As the Master key is rotated to the right, the construction pin will drop into the hole in the plug, thereby eliminating any future use of the construction key.

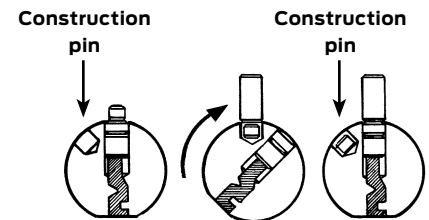

Locks with Blockokey® cylinders

All lock cylinders on a specific project are operable by a special “project key.” Duplicates of this key may be assigned by the building contractor to workmen and subcontractors as required. No regular change keys or Master keys are needed on the job. This eliminates the possibility of subsequent exposure from lost or stolen keys.

How to order locks with Blockokey® cylinders

Blockokey® locksets are ordered by adding the word “Blockokey” after the balance of the ordering information.

Example: 72 W511PD DAN 626 RH 30-209 30-149 1AA-72AA (Blockokey)

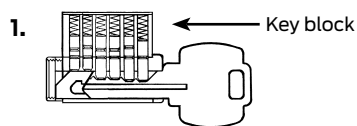

Project key—KB531

Operation of the lock cylinder is by the special “project key.” The last two pins in the cylinder are inoperative because of the “key block” mechanism.

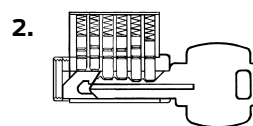

Removal tool – KB536

The “project key” no longer operates the cylinder when the “key block” mechanism is removed. A key block removal tool comes with the master keys for the locks. Push the removal tool into the keyway and then withdraw it to remove the block. Thereafter the project key will no longer operate the lock cylinder.

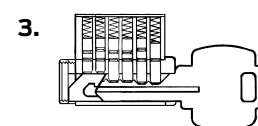

Change or master key—KB578

Cylinder is now only operable by the regular change key or Master key.

Conversion chart

W Series grade 2 cylindrical key-in-lever

ANSI number/grade	Function	Falcon	Arrow	Cal-Royal	Corbin/Russwin	Dorma	Hager	Marks	Best
C75	Passage	W101	RL01	SL-30	CL3810	CL710	3510	N	7KN
	Comm/exit	W161	RL03	SL-50	—	CL725	3525	DC	—
F77	Patio	W201	FL04	—	CL3840	CL730	—	P	—
F76	Privacy	W301	FL02	SL-20	CL3820	CL740	3540	L	7KL
F109	Entry/office	W511	RL11	—	CL3851	CL753	3553	AB	7KAB
F84	Classroom	W561	RL17	SL-03	CL3855	CL770	3570	S	7KR
F86	Storeroom	W581	RL12	SL-05	CL3851	CL780	3580	F	7KD
	Apt. Entry	W711	—	—	—	—	—	—	—
	Dummy single	W12	RL08	SL-40	CL3850	CL701	3517	DO	7KIOT
F82	Entry	W501	—	SL-00	CL3861	CL750	—	B	—

Trim styles

Falcon	Arrow	Cal-Royal	Corbin/Russwin	Dorma	Hager	Marks	S. Parker
Dane	SR	SL	NZD	LR	Withnell	170	SL
Quantum	BRR	RL	PZD	LC	Archer	270	—

All effort has been made to make this information comprehensive. Since no two products are exactly alike, this data represents those products which are similar. This information was obtained from trade services and is not guaranteed nor meant to represent any product as equal to any other product.

How to order

For correct ordering and to ensure no delays in shipment of your order, the following descriptive data must be listed in the sequence shown. Necessary information can be found in other parts of this catalog. The example to the right shows an order for 12 each W locksets in the 581 storeroom function, QUA (Quantum) trim design in a 626 (satin chrome) finish, with a 2 3/4" backset latch, to accommodate doors 1 3/4" thick.

- **Quantity:** Indicate the quantity required.
- **Catalog number:** Select function number, cylinder type, and latch style from tables in this section.
- **Trim design:** Indicate letter of lever design. DAN = Dane; QUA = Quantum; ELI = Elite; HAN = Hana. If Falcon W Series small rose is required, specify SR = Small Rose. Outside design always precedes inside design on split designs. If adding an abrasive lever option, add 6 to design code (example 6DAN).
- **Finish:** When the finish is the same for the outside and inside trim, it is shown once (626). Outside finish always precedes inside finish on split finishes (605 x 625).
- **Latches:** 2 3/4" backset is standard. 2 3/8" backset available. All latches are UL listed 3-hour A label.
- **Strikes:** 4 7/8" x 1 1/4" ANSI standard. For other options, see page 12.
- **Cylinder type:** 6-pin.
- **Keying detail:** We suggest using the standard terms developed by DHI (Door and Hardware Institute) or ALOA (Associated Locksmiths of America).
 - Example: AA1 - Grand Master keyed, Master keyed, change key 1.
- **Interchangeable core:** To order product capable of accepting an interchangeable core, add suffices from the keying table to the function number, preceding the latch style.
 - Example: W511HD will be supplied with SFIC keyed construction core.
- **Keyways:** "G" is standard on regular cylinders. "A" is standard on interchangeable cores. Other keyways available. See page 9.
- **Additional keys:** Note the total number of keys required.
- **Large bow keys:** Add—"with large bow keys" under additional details.

How to order example

Line item	Qty.	Product	Outside		Inside		Hand	Latch	Strike	Door thickness	Ext.	DIM	Additional details/keying
			Des	Fin	Des	Fin							
1	12	W581D	QUA	626			RHR	30-197	30-149	1 3/4"			

Finishes

The latest in modern techniques and equipment are used to apply the highest quality finish. Extra steps assure durable, consistent finishes and long useful life.

Although we apply the finest available protective plating and/or enamel coating to the surface of our products, these finishes have limitations and in time may deteriorate either from exposure to weather, pollution, perspiration, extremes

of climate, frequency of use or other factors. Deterioration of these finishes is, therefore, not a defect, but a normal process which is unavoidable. Our company cannot accept responsibility for finish deterioration in these circumstances, and therefore the finishes cannot be guaranteed. These products will not be refinished or replaced under our warranty should deterioration of finishes occur.

Trim finishes chart

Description	ANSI No.	Available on
Bright brass	605	All trim
Satin brass	606	All trim
Oil rubbed bronze	613	All trim
Bright chrome	625	All trim
Satin chrome	626	All trim

Note: Not available on W Series small rose levers.

Auxiliary locks

Deadlocks and deadbolts

Deadbolt locks provide an extra measure of protection against break-in when used as a supplement to an existing lockset. In applications ranging from military and government projects to multi-family housing, retail and restaurants, Falcon deadbolts deliver superior performance and the flexibility of multiple keying systems. Our full line of Grade 1 and 2 auxiliary locks feature interchangeable cores that are compatible with SFIC products from other manufacturers. And they're backed by Allegion, the best name in the business.

Features

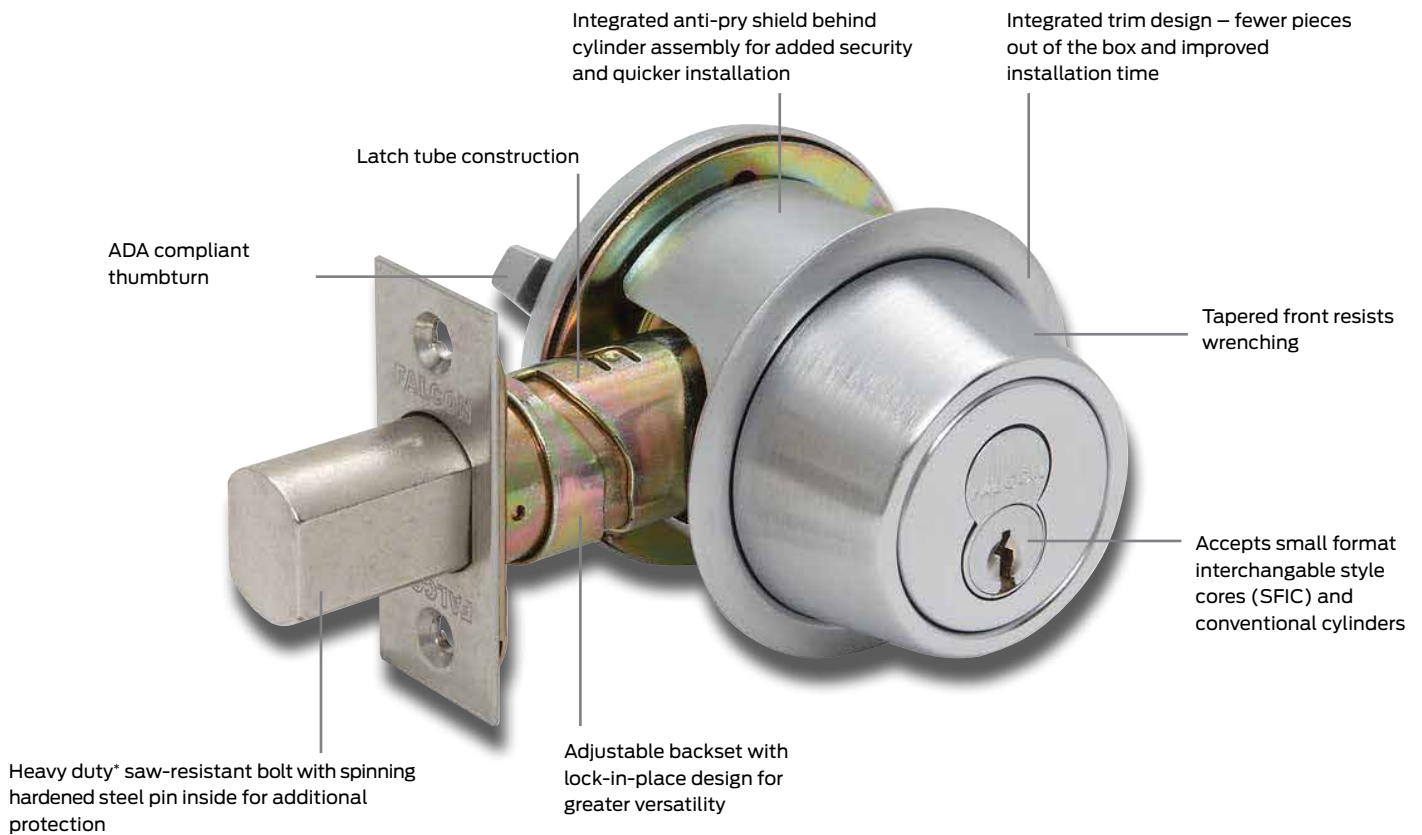

*Grade 1 - High strength steel - powdered
Grade 2 - Zinc

D100 Series

Grade 1, heavy-duty deadlocks

Features

Door thickness: $1\frac{3}{8}$ " to $1\frac{3}{4}$ " Up to $2\frac{1}{4}$ " door thickness also available.

Backsets: $2\frac{3}{8}$ " - $2\frac{3}{4}$ " adjustable deadbolt.

Attachment: Locks are solidly attached to the door by $\frac{1}{4}$ " heat-treated steel bolts. These bolts pass through a steel plate (D111, D121 and D141) or the inner cylinder housing (D131) and thread directly into the back of the outer cylinder housing.

A permanent cap is inserted over the inside cylinder (D131) making the bolts nearly impossible to remove.

Handing: Non-handed. May be used on right hand or left hand doors swinging in or out.

Cylinders: Furnished with solid brass plug and housing, drilled with 6-pin chambers, pinned in 5 unless otherwise specified. Also available with 7-pin cylinders. Available with 6 or 7-pin interchangeable cores. Furnished with two (2) nickel silver keys standard.

Keyways: "G" keyway standard on conventional cylinders. "A" keyway standard on I/C core cylinders. Also available with some optional keyways.

Exposed trim: Wrought brass or bronze reinforced with steel insert.

Deadbolts: Deadbolt locks are furnished with deadbolts which have a full 1" projection. Housed within the deadbolt is a free-turning, $\frac{1}{4}$ " thick, hardened steel, saw-resistant roller. Furnished standard with $2\frac{3}{8}$ " - $2\frac{3}{4}$ " adjustable backset and $1\frac{1}{8}$ " x $2\frac{1}{4}$ " faceplate. Optional 1" x $2\frac{1}{4}$ " faceplate. Consult Options and Accessories section for other optional faceplates. D100 bolt is high strength steel.

Strikes: $2\frac{3}{4}$ " x $1\frac{1}{8}$ " lipless strike standard. ANSI $4\frac{7}{8}$ " x $1\frac{1}{4}$ " lipless, $2\frac{1}{4}$ " full lip strikes, a $2\frac{3}{4}$ " x $1\frac{1}{8}$ " T-strike or a security strike are available. Consult options and accessories section.

Screws: Furnished with wood/machine screws for use on wood or metal doors or frames.

ANSI/BHMA Standard: A156.5, 2001, Grade 1.

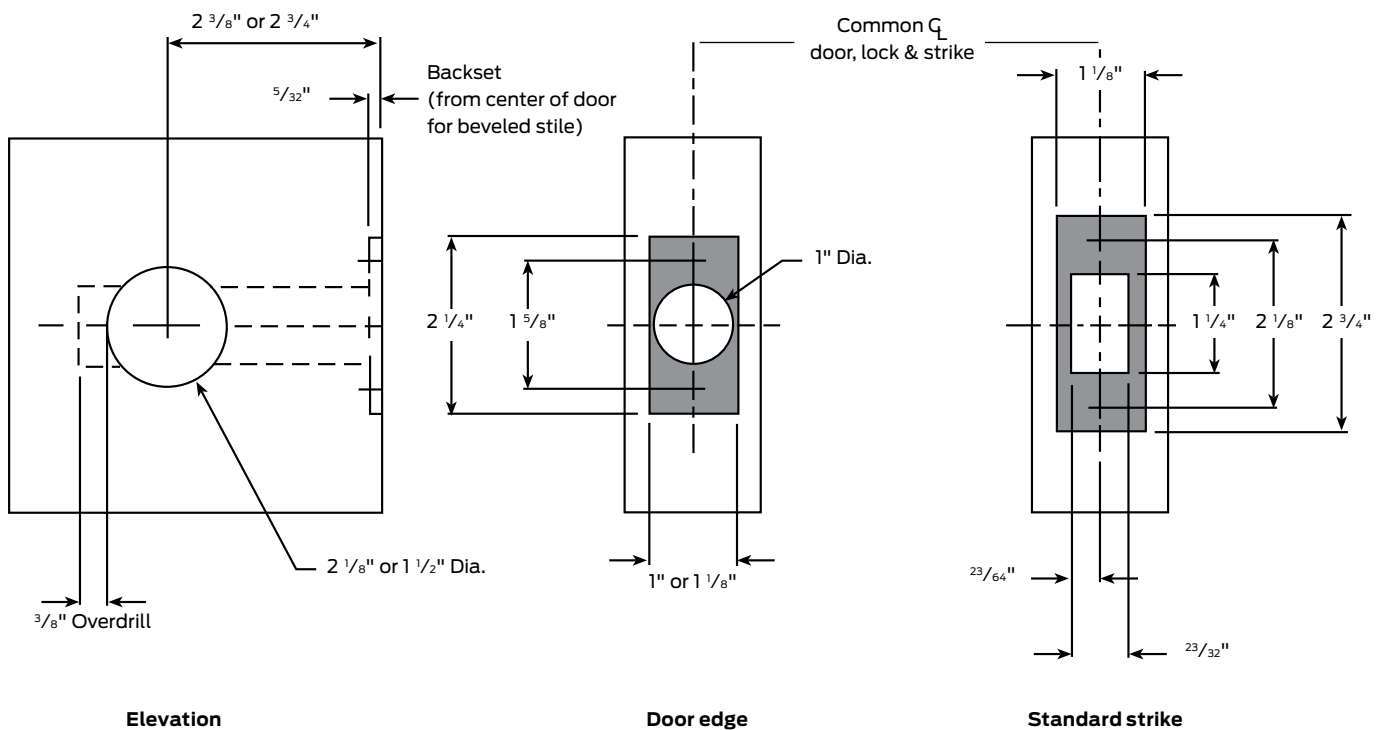

Deadlock styles

D100 Series

Classroom deadlock (schoolhouse safety)

Deadbolt thrown or retracted by key from outside. Inside turn will only retract bolt. Bolt automatically deadlocks when fully thrown.

ANSI/BHMA E01711



D111



Single cylinder deadlock

Deadbolt thrown or retracted by key only. Blank plate inside. Bolt automatically deadlocks when fully thrown.

ANSI/BHMA E01611



D121



Double cylinder deadlock

Deadbolt thrown or retracted by key from either side. Bolt automatically deadlocks when fully thrown.

ANSI/BHMA E01411



D131



Single cylinder deadlock with turn

Deadbolt thrown or retracted by key or by turn. Bolt automatically deadlocks when fully thrown.

ANSI/BHMA E01511



D141



D200 Series

Grade 1, medium-duty deadlocks

Features

Door thickness: $1\frac{3}{8}$ " to $1\frac{7}{8}$ ". For thicker doors, available up to $2\frac{1}{4}$ ".

Backsets: $2\frac{3}{8}$ " - $2\frac{3}{4}$ " adjustable deadbolt.

Attachment: Locks are solidly attached to the door by $\frac{1}{4}$ " heat-treated steel bolts. These bolts pass through a steel plate (D211, D221 and D241) or the inner cylinder housing (D231) and thread directly into the back of the outer cylinder housing.

Handing: Non-handed. May be used in right hand or left hand doors swinging in or out.

Cylinders: Furnished with solid brass plug and housing, drilled with 6-pin chambers, pinned in 5 unless otherwise specified. Available with 6 or 7-pin interchangeable cores. Furnished with two (2) nickel silver keys standard.

Keyways: "G" keyway standard on conventional cylinders. "A" keyway standard on I/C core cylinders. Also available with some optional keyways.

Exposed trim: Wrought brass or bronze reinforced with steel insert.

Deadbolts: Deadbolt locks are furnished with deadbolts which have a full 1" projection. Housed within the deadbolt is a free-turning, $\frac{1}{4}$ " thick, hardened steel, saw-resistant roller. Furnished standard with $2\frac{3}{8}$ " - $2\frac{3}{4}$ " adjustable backset and $1\frac{1}{8}$ " x $2\frac{1}{4}$ " faceplate. Optional 1" x $2\frac{1}{4}$ " faceplate. Consult Options and Accessories section for other optional faceplates. D200 bolt is cast zinc.

Strikes: $2\frac{3}{4}$ " x $1\frac{1}{8}$ " lipless standard. ANSI $4\frac{7}{8}$ " x $1\frac{1}{4}$ " lipless, $2\frac{1}{4}$ " full lip strikes, a $2\frac{3}{4}$ " x $1\frac{1}{8}$ " T-strike or a security strike are available. Consult Options and Accessories section.

Screws: Furnished with wood/machine screws for use on wood or metal doors or frames.

ANSI/BHMA Standard: A156.5, 2001, Grade 2.

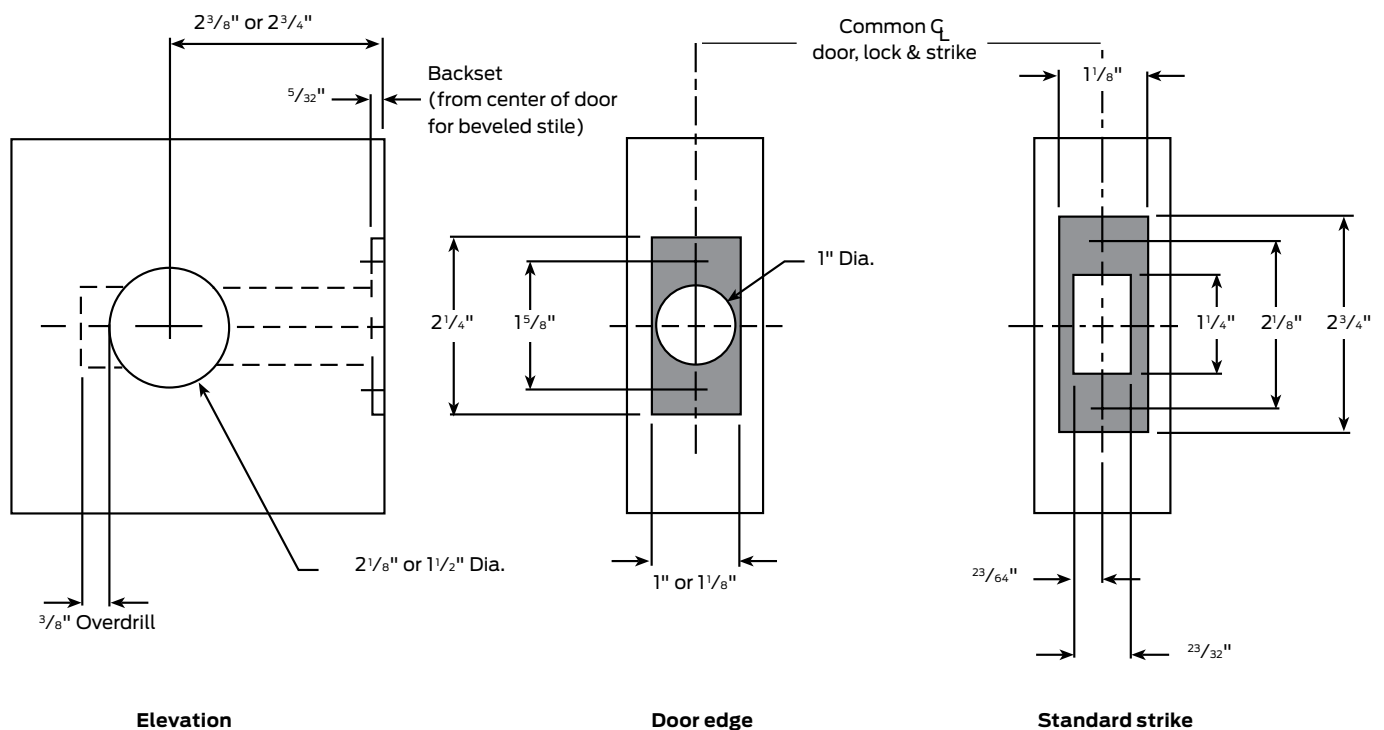

Auxiliary locks

Deadlock styles

D200 Series

Classroom deadlock (schoolhouse safety)

Deadbolt thrown or retracted by key from outside. Inside turn will only retract bolt. Bolt automatically deadlocks when fully thrown.

ANSI/BHMA E01712



D211



Cylinder deadlock

Deadbolt thrown or retracted by key only. Blank plate inside. Bolt automatically deadlocks when fully thrown.

ANSI/BHMA E01622



D221



Double cylinder deadlock

Deadbolt thrown or retracted by key from either side. Bolt automatically deadlocks when fully thrown.

ANSI/BHMA E21422



D231



Single cylinder deadlock with turn

Deadbolt thrown or retracted by key or by turn. Bolt automatically deadlocks when fully thrown.

ANSI/BHMA E21522



D241



Lock features

D200 Series

Deadbolt thrown or retracted by turn unit only. No outside trim. Bolt automatically deadlocks when fully thrown.

ANSI/BHMA E2192



D261

Deadbolt thrown or retracted by turn unit only. Occupancy indicator on outside (reads either in use or vacant with color coding). Bolt automatically deadlocks when fully thrown.

Emergency key supplied.



D271

Deadbolt thrown or retracted by turn unit only. Outside blank rose. Bolt automatically deadlocks when fully thrown.

ANSI/BHMA E01112



D261M

Conversion chart

D100 Series – Grade 1

ANSI	Function	Falcon	Best	Corbin/Russwin	Sargent	Yale
E01711	Schoolhouse safety	D111	83S	DL2017	487	3362
E01611	Cylinder X blank	D121	83L	DL2011	486	3332
E01411	Double cylinder	D131	83M	DL2012	484	3322
E01511	Cylinder X turn	D141	83K	DL2013	485	3312

D200 Series – Grade

ANSI	Function	Falcon	Best	Russwin	Sargent	Yale
E01712	Schoolhouse safety	D211	N/A	DL2017	487	N/A
E01622	Cylinder X blank	D221	73L	DL2011	486	N/A
E01422	Double cylinder	D231	73M	DL2012	484	N/A
E21522	Cylinder X turn	D241	73K	DL2013	485	N/A
E2192	Turn inside only	D261	N/A	DL3060	489	N/A

Metric conversion table

$\frac{1}{32}'' = .79 \text{ mm}$	$\frac{3}{16}'' = 4.76 \text{ mm}$	$\frac{1}{2}'' = 12.70 \text{ mm}$	$\frac{15}{16}'' = 23.81 \text{ mm}$
$\frac{1}{16}'' = 1.58 \text{ mm}$	$\frac{1}{4}'' = 6.35 \text{ mm}$	$\frac{9}{16}'' = 14.28 \text{ mm}$	$1'' = 25.40 \text{ mm}$
$\frac{3}{32}'' = 2.38 \text{ mm}$	$\frac{5}{16}'' = 7.93 \text{ mm}$	$\frac{5}{8}'' = 15.87 \text{ mm}$	$2\frac{3}{8}'' = 60 \text{ mm}$
$\frac{1}{8}'' = 3.17 \text{ mm}$	$\frac{11}{32}'' = 8.73 \text{ mm}$	$\frac{3}{4}'' = 19.05 \text{ mm}$	$2\frac{3}{4}'' = 70 \text{ mm}$
$\frac{5}{32}'' = 3.96 \text{ mm}$	$\frac{3}{8}'' = 9.52 \text{ mm}$	$\frac{7}{8}'' = 22.22 \text{ mm}$	$5'' = 127 \text{ mm}$

H Series

Interconnected locks

Features

Door thickness: 1³/₈" to 1³/₄".

Backset: 2³/₄" standard, 2³/₈" also available.

Attachment: Outer trims secured to the door by thru-bolts through a steel plate on the inside of the door. Inside escutcheon conceals mounting screws.

Handing: Specify hand of door when ordering. Field reversible.

Cylinders: "G" keyway standard. Drilled in 6 chambers, pinned in 5. Pinning in 6 chambers available when specified. Also available with 6 or 7-pin interchangeable core cylinders in H101 function only.

Trim: Roses are wrought brass, bronze or stainless steel, installed over wrought steel reinforcing plates. Knobs are brass, bronze or stainless steel secured by steel knob retainer which cannot be depressed when lock has been locked.

Latches: 1/2" projection, deadbolt has 1" projection with 1/4" hardened steel security roller. 2³/₄" backset with 2¹/₄" x 1¹/₈" latchface. 2³/₈" backset with 2¹/₄" x 1" latchface. Other latchfaces available.

Strikes: (1) 2³/₄" x 1¹/₈" T-strike and (1) 2³/₄" x 1¹/₈" lipless strike.

Mechanism: Cold formed steel, zinc plated and dichromated for rust resistance.

Certification: UL Listed 1¹/₂ Hour B Label. Lever-style trim complies with Title 19, California State Fire Marshal and all ADA and barrier-free codes.



Trim design dimensions

Trim design	Knob or lever	Rose diameter	Projection
H	2 ¹ / ₈ "	3"	2 ³ / ₄ "
E	2"	3"	2 ³ / ₄ "
D	4"	3"	2 ¹ / ₂ "

K900 Series

Padlocks

A pin tumbler padlock manufactured from solid bar stock brass, with chrome-plated, case-hardened steel shackle. The entire cylinder assembly is removable for easier rekeying or quick cylinder change. Note: Key is removable in locked position. Padlocks with longer shackles (2" or 6") available when specified. 1" shackle is standard.

Cylinders: Furnished with solid brass plug and housing, drilled with 6-pin chambers, pinned in 5 unless otherwise specified. Also available with 7-pin cylinder. Furnished with two (2) nickel silver keys standard.

Keyways: "G" keyway standard on standard cylinders.

Interchangeable core (SFIC) padlocks, branded Schlage, are also available. See pricebook for details.

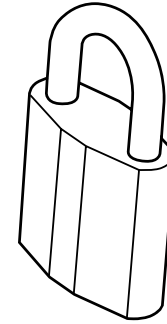

955 Deadlocking type padlock

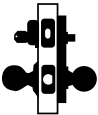
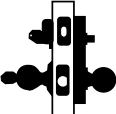
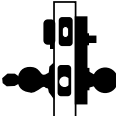
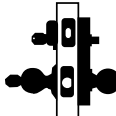
Catalog number	Function	Description	ANSI no.
H101		Entry single locking—Latch bolt operated by knob or lever from either side. Rotating turn from inside or key from outside extends dead bolt. Dead bolt and latch bolt retract by rotating inside knob or lever.	F94
H451		Hotel/motel lock—Deadlocking latch bolt operated by key outside or rotating inside knob/lever. Outside knob/lever rigid. Rotating turn from inside or emergency key outside extends dead bolt. Both deadbolt and deadlocking latch bolt retract by rotating inside knob/lever. Depressing spanner button in inside knob/lever operates visual indicator shutting out all keys except emergency key. Rotation of inside spanner button provides lockout feature. Levers are available only on the inside trim of this function.	F100
H461		Hotel/motel lock—Deadlocking latch bolt operated by key outside or rotating inside knob/lever. Outside knob/lever rigid. Rotating turn from inside extends dead bolt and changes visual message on outside from vacant to occupied. Both deadbolt and deadlocking latch bolt retract by rotating inside knob/lever. Depressing spanner button in inside knob/lever operates visual indicator shutting out all keys except emergency key. Rotation of inside spanner button provides lockout feature. Levers are available only on the inside trim of this function.	F101
H511		Entry double locking—Dead bolt thrown or retracted by key in upper lock from outside or by inside turn. Deadlocking latch retracted by key in outer knob/lever when locked by pushing button in inner knob. Outer knob/lever may be fixed in locked position by rotating button. Dead bolt and latch bolt retracted by rotating inside knob/lever. Levers are available only on the inside trim of this function.	F96/97

Options and accessories

H Series deadbolts - 1" projection, standard

Standard deadbolts for H Series locks are non-UL listed. Available in 2³/₈" or 2³/₄" backsets.

Unless otherwise specified, we furnish a 2¹/₄" x 1" square-corner faceplate on 2³/₈" backset deadbolts and 2¹/₄" x 1¹/₈" x square corner on 2³/₄" backset deadbolts.

*Optional UL deadbolt available, except on drive-in deadbolts.

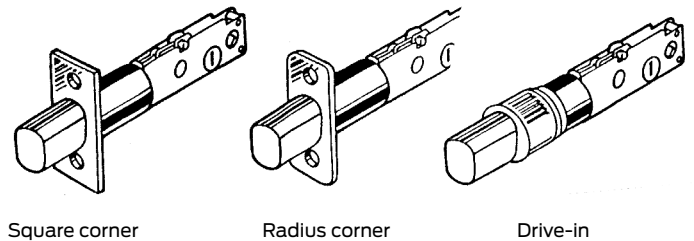

Deadbolts for H Series - (except for double cylinder deadlock function and upper trim)

Catalog number	Description	Faceplate size	Corner
A74420-000	2 ³ / ₈ " Backset dead bolt	2 ¹ / ₄ " x 1"	Square
A74421-000	2 ³ / ₈ " Backset dead bolt	2 ¹ / ₄ " x 1"	Radius
A74425-000	2 ³ / ₈ " Backset dead bolt	2 ¹ / ₄ " x 1 ¹ / ₈ "	Square
A76429-000	2 ³ / ₈ " Backset dead bolt	Drive-in	Round
A74430-000	2 ³ / ₄ " Backset dead bolt	2 ¹ / ₄ " x 1"	Square
A74431-000	2 ³ / ₄ " Backset dead bolt	2 ¹ / ₄ " x 1"	Radius
A74435-000	2 ³ / ₄ " Backset dead bolt	2 ¹ / ₄ " x 1 ¹ / ₈ "	Square
A76439-000	2 ³ / ₄ " Backset dead bolt	Drive-in	Round

Deadbolts for H Series - double cylinder deadlock function only

Catalog number	Description	Faceplate size	Corner
A84420-000	2 ³ / ₈ " Backset dead bolt	2 ¹ / ₄ " x 1"	Square
A84421-000	2 ³ / ₈ " Backset dead bolt	2 ¹ / ₄ " x 1"	Radius
A84425-000	2 ³ / ₈ " Backset dead bolt	2 ¹ / ₄ " x 1 ¹ / ₈ "	Square
A86429-000	2 ³ / ₈ " Backset dead bolt	Drive-in	Round
A84430-000	2 ³ / ₄ " Backset dead bolt	2 ¹ / ₄ " x 1"	Square
A84431-000	2 ³ / ₄ " Backset dead bolt	2 ¹ / ₄ " x 1"	Radius
A84435-000	2 ³ / ₄ " Backset dead bolt	2 ¹ / ₄ " x 1 ¹ / ₈ "	Square
A86439-000	2 ³ / ₄ " Backset dead bolt	Drive-in	Round

Specify finish: 606, 613, 626 or 630.

Strikes

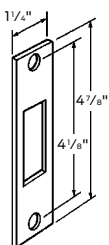

030020-000
ANSI Strike

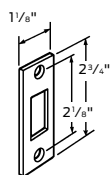

010018-001
Lipless strike

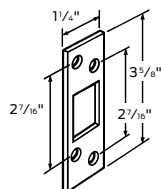

030290-000
T-strike or security

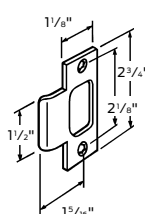

005075-000
T-strike,
square corner

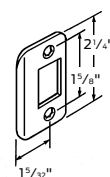

005051-000
Full lip,
square corner

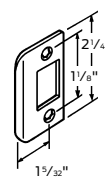

005051-001
Full lip,
1/4 radius corner

Options and accessories

(continued)

Dust boxes

B500-622

Metal dustbox reinforcer for 10-094 strike.

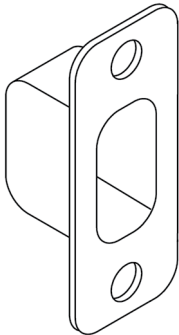

Mounted samples



Individual mounted lock samples are available in auxiliary locks. Mounted locks are fully operative, thus demonstrating their individual features. Light and portable, they may be easily carried for on-site demonstrations.

945 Standard cylinder cam lock

Cam lock for cabinet doors up to $\frac{3}{4}$ " thick. Large cam measures $1\frac{1}{2}$ " center-to-end. Provided with two cam drivers to allow for rigid cam or lazy cam operation. Lock is field-reversible for right hand or left hand doors.

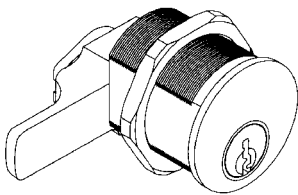

Lazy action operation:

1. Key rotates cam 90° .
2. Set screw limits cam rotation to 90°
3. Key removable in locked or unlocked position.

C945 SFIC (less core) cam lock

Cylinders: Furnished with solid brass plug and housing drilled with 6-pin chambers, pinned in 5 unless otherwise specified. Available with 6- or 7-pin interchangeable cores. Furnished with two (2) nickel silver keys standard.

Keyways: "G" keyways standard on standard cylinders. "A" keyway standard on I/C core cylinders.

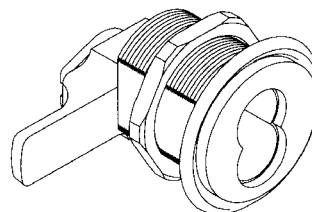

Rigid driver operation:

1. Key rotates cam 360° .
2. Set screw limits cam rotation if required.
3. Key removable in locked position only.

Mounting screws

Part number	Specify finish	Description		Application	
		Size	Type	Use	Door thickness
Keyed, single conventional cylinder					
B600-100		1/4"-28 x 1 ¹⁵ / ₁₆ "	POH mach.	Mounting	1 ³ / ₈ " - 1 ³ / ₄ "
B600-101		1/4"-28 x 1 ¹⁵ / ₁₆ "	POH mach.	Mounting	1 ³ / ₈ " - 2 ¹ / ₄ "
B600-066		6-32 x 1/4"	PH mach.	Turn	-
B520-298		10-32 x 3/8"	PH mach.	Anti-pry shield	-
Keyed, single SFIC cylinder					
B600-100		1/4"-28 x 1 ¹⁵ / ₁₆ "	POH mach.	Mounting	1 ³ / ₈ " - 2 ¹ / ₄ "
B600-066		6-32 x 1/4"	PH mach.	Turn	-
Keyed, double conventional cylinder					
B600-047		1/4"-28 x 3 ¹³ / ₁₆ "	PH mach.	Mounting	1 ³ / ₈ " - 1 ³ / ₄ "
B600-078		1/4"-28 x 1 ²⁹ / ₆₄ "	PH mach.	Mounting	1 ³ / ₈ " - 2 ¹ / ₄ "
B520-298		10-32 x 3/8"	PH mach.	Anti-pry shield	-
Keyed, double SFIC cylinder					
B600-053		1/4"-28 x 3 ⁶¹ / ₆₄ "	PH mach.	Mounting	1 ³ / ₈ " - 2 ¹ / ₄ "
B520-298		10-32 x 3/8"	PH mach.	Anti-pry shield	-
Keyless, D261					
B600-066		6-32 x 1/4"	PH mach.	Turn	-
B600-048		10-32 x 1/2"	PH mach.	Mounting plate	-
F506-359		#8 x 3/4"	RH wood	Mounting plate	-
Keyless, D261M, D271					
B520-662		10-32 x 1 ³ / ₄ "	POH mach.	Mounting	-
B520-663		10-32 x 1 ³ / ₄ "	POH mach.	Mounting	-
B600-066		6-32 x 1/4"	PH mach.	Turn	-
All functions					
C603-897		#8 x 3/4"	PFH combo.	Deadbolt & strike	-
J520-028		#8 x 2"	PFH wood	2" strike screw	-
R525-256		#12 x 3"	PFH wod	3" metal dust box	-

How to order

For correct ordering, and to ensure no delays in processing of your order, the following descriptive data should be listed in the sequence shown. Necessary information can be found in other parts of this catalog. The example below shows an order for 20 each D locksets in the 141 Entry function, in a 626 (satin chrome) finish, to accommodate doors 1 3/4" thick with AA1- AA20 keying.

- **Quantity:** Indicate the quantity required.
- **Catalog number:** Select function number.
- **Cylinder type:** P = conventional cylinder, L=prepped for conventional cylinder, but less cylinder, B=prepped for SFIC, but less cylinder, BB=with Best style capped core, BDC=with disposable construction core, G=with Falcon slide cap core, H=with keyed construction core.
- **Bolt type:** D for deadbolt.
- **Finish:** When the finish is the same for the outside and inside trim, it is shown once (626). Outside finish always precedes inside finish on split finishes (605 x 625).
- **Latches:** 2 3/4" backset is standard. 2 3/8" backset available. All latches are UL listed 3-hour A label.
- **Strikes:** 4 7/8" x 1 1/4" ANSI standard. For other options, see page 12.
- **Cylinder type:** 6-pin.
- **Latch:** 2 3/8" - 2 3/4" universal backset - standard.
- **Strike:** 2 3/4" x 1 1/8" lipless standard. Optional ANSI, T-strike, full lip strikes or security strike available.
- **Cylinder type:** For 6-pin, add 6-pin. For 7-pin, add 7-pin. 7-pin conventional cylinder is not available on the H Series.
- **Door hand:** Not required. All other locks are fully reversible.
- **Keying detail:** We suggest using the standard terms developed by the A.H.C. (Architectural Hardware Consultants).
 - Example: AA1 - Grand Master keyed, Master keyed, change key 1.
- **Interchangeable core:** Specify for 6 or 7 pin if ordering prepped for interchangeable core (SFIC). BD6 or BD7, GD6 or GD7, BB6 or BB7.
- **Keyways:** "G" is standard on regular cylinders. "A" is standard on interchangeable cores. Other keyways available. Please consult factory.
- **Additional keys:** Note the total number of keys required.
- **Large bow keys:** Add—"with large bow keys" under additional details.

How to order example

Qty.	Catalog number	Trim design	Finish	Latch	Strike	Cylinder	Detail
20	D141PD	—	626	STD	STD	6-pin	AA1-AA20 1 3/4" DR

Finishes

The latest in modern techniques and equipment are used to apply the highest quality finish. Extra steps assure durable, consistent finishes and long useful life.

Although we apply the finest available protective plating and/or enamel coating to the surface of our products, these finishes have limitations and in time may deteriorate either from exposure to weather, pollution, perspiration, extremes

of climate, frequency of use or other factors. Deterioration of these finishes is, therefore, not a defect, but a normal process which is unavoidable. Our company cannot accept responsibility for finish deterioration in these circumstances, and therefore the finishes cannot be guaranteed. These products will not be refinished or replaced under our warranty should deterioration of finishes occur.

Trim finishes chart

Description	ANSI No.	Available on
Bright brass	605	All trim
Satin brass	606	All trim
Oil rubbed bronze	613	All trim
Bright chrome	625	All trim
Satin chrome	626	All trim

Note: Consult price book for finish availability by product.

MA Series

Grade 1 mortise lever and knob locks

Deadbolt locks provide an extra measure of protection against break-in when used as a supplement to an existing lockset. In applications ranging from military and government projects to multi-family housing, retail and restaurants, Falcon deadbolts deliver superior performance and the flexibility of multiple keying systems. Our full line of Grade 1 and 2 auxiliary locks feature interchangeable cores that are compatible with SFIC products from other manufacturers. And they're backed by Allegion, the best name in the business.

Features



*Excludes MA551

**For 605, 606, 613, 625 and 626

Mortise locks

Lock features

Door thickness: Standard accommodates thickness of 1³/₈" to 2¹/₂".

Backset: 2³/₄" only.

Case: Cold formed steel, zinc dichromate plated, .090" thick. Optional lead wrapping available.

Hubs: Hardened steel.

Handing: Right hand is standard; left hand optional. Reversible in the field.

Cylinders: Solid brass cylinder and plug. 5, 6 or 7-pin are available on standard cylinders. 6 or 7-pin are available on interchangeable core cylinder. Furnished with two nickel silver keys standard

Keyways: "G" keyway standard on standard cylinder. "A" keyway standard on I/C cylinder. See price book for optional keyways

Bind resistant trim: Heavy-duty through-bolted inserts clamp the trim on the door assuring proper alignment. Provided with 8-32 screws for strength and thread sealant to prevent loosening.

Latch bolt: Two-piece stainless steel, mechanical anti-friction bolt. ³/₄" projection.

Dead bolt: 1" throw, stainless steel with two 1³/₁₆" diameter hardened steel, free-turning, saw-resistant roller.

Faceplates: (armored front) 1¹/₄" x 8" brass or stainless steel adjustable for door bevel. Reinforced by heavy gauge steel with stabilizing ribs.

Strike: Brass or stainless steel. Meets ANSI AII5.1 for frame preparation. Strike is non-handed.

Electrified functions: Available in 12 or 24 VDC.

ANSI/BHMA: Meets ANSI/BHMA 156.13, Series 1000.

UL: 3 hour A label.

Falcon mortise lock specifications

- Provide mortise locksets that comply with ANSI A156.13, Series 1000, Operational Grade 1 and Security Grade 1 with all standard trims and conventional mortise cylinders.
- Locksets comply with UL10B - neutral pressure and UL10C/UBC 7-2 - positive pressure testing requirements. All locks shall be UL listed for 3 hour fire door.
- Lock case shall be non-handed, reversible without opening the lock case, and shall be manufactured of zinc dichromate plated steel. Lock case shall be interchangeable for knob or lever applications without modifying the chassis, and shall be constructed with a screw configuration that limits access to operating parts.
- Latchbolt shall be 2-piece anti-friction type manufactured from stainless steel, with a standard 2³/₄" backset, a full ³/₄" throw and be field reversible. Deadbolt shall have 1" throw and shall be constructed of stainless steel, incorporating two ³/₁₆" diameter security roller pins.
- All trim shall be cast, forged, or wrought and through bolted with thread patch coated screws. Lever trim to have individual heavy duty springs for lever return, and independent rotation in both directions. Return to door style levers meets the ¹/₂" California State Fire Marshall requirement.
- Spindles to be independent, designed to 'break-away' at a maximum of 480 in./lbs. to prevent damage to the lock chassis.
- Provide standard non-handed curved lip strikes.
- Cylinders to be secured by a dual retainer. Acceptable manufacturer: Falcon Lock

Mortise locks

Dimensions

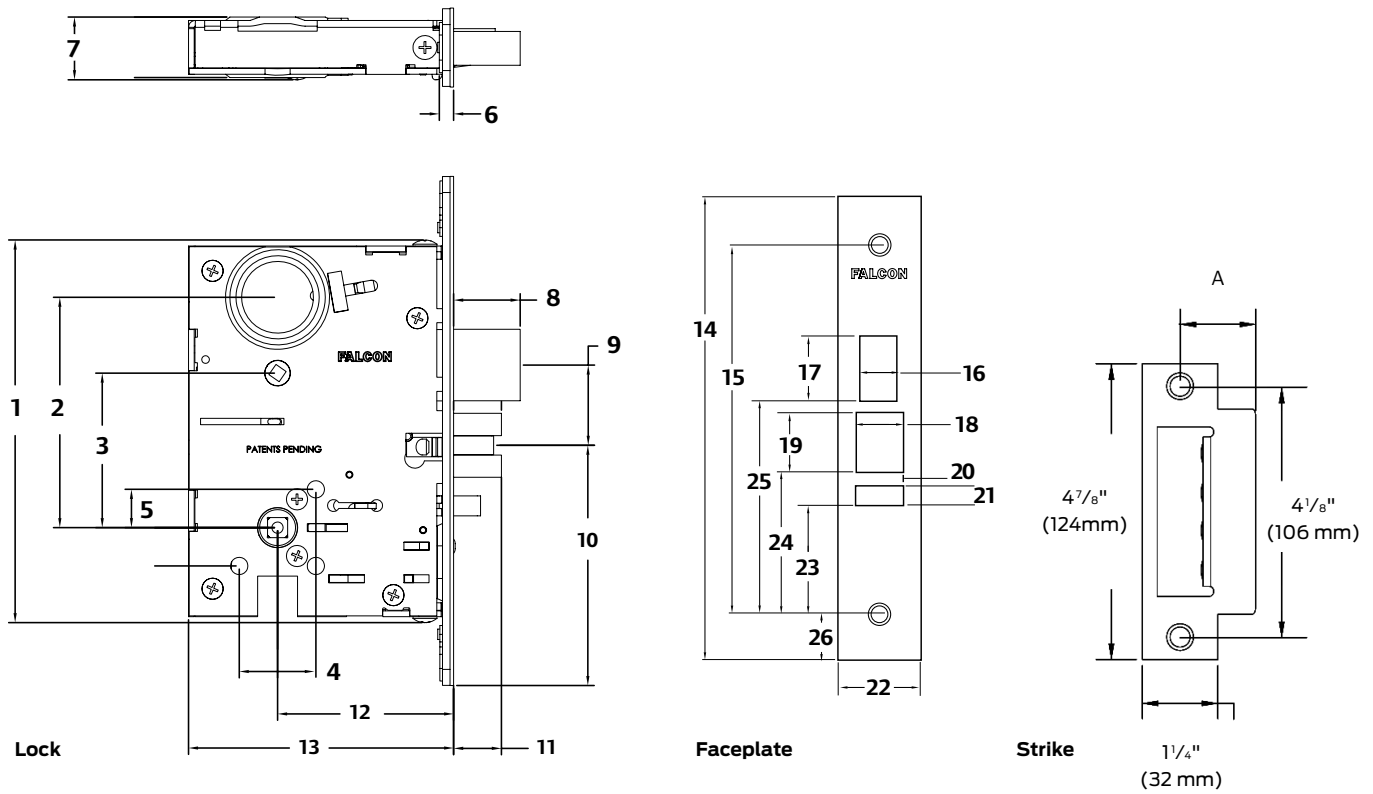

Lock	Dimension
1	6" (152 mm)
2	3 ³⁹ / ₆₄ " (92 mm)
3	2 ²⁷ / ₆₄ " (62 mm)
4	1 ³ / ₁₆ " (30 mm)
5	¹⁹ / ₃₂ " (15 mm)
6	¹ / ₄ " (6 mm)
7	1" (25 mm)
8	1" (26 mm)
9	1 ¹⁷ / ₆₄ " (32 mm)
10	3 ⁴⁹ / ₆₄ " (96 mm)
11	³ / ₄ " (19 mm)
12	2 ³ / ₄ " (70 mm)
13	4 ⁵ / ₃₂ " (106 mm)

Faceplate	Dimension
14	8" (203 mm)
15	6 ³ / ₈ " (162 mm)
16	⁹ / ₁₆ " (14 mm)
17	1 ⁹ / ₆₄ " (29 mm)
18	⁴⁵ / ₆₄ " (18 mm)
19	1 ¹ / ₃₂ " (26 mm)
20	¹ / ₄ " (6 mm)
21	¹¹ / ₃₂ " (9 mm)
22	1 ¹ / ₄ " (31 mm)
23	1 ²⁷ / ₃₂ " (47 mm)
24	2 ⁷ / ₁₆ " (62 mm)
25	3 ²¹ / ₃₂ " (93 mm)
26	²⁵ / ₃₂ " (20 mm)

Strike

(A) Door thickness	Lip size
1 ³ / ₄ "	1 ¹ / ₄ " (32 mm)
2"	1 ⁷ / ₁₆ " (37 mm)
2 ¹ / ₄ "	1 ⁹ / ₁₆ " (40 mm)
2 ¹ / ₂ "	1 ¹¹ / ₁₆ " (43 mm)

Levers, knob and trims



G
Gala rose

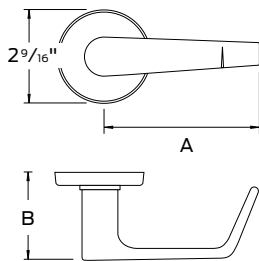

Number	A - width	B - projection
AG	4 1/2"	2 7/8"
DG	4 1/2"	2 1/2"
QG	4 3/4"	3"
SG	4 7/8"	3"



N
Napa escutcheon

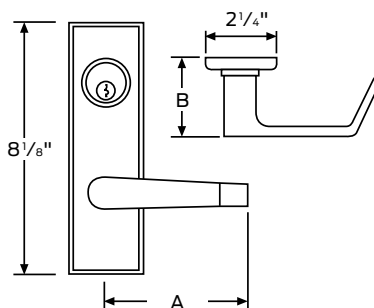

Number	A - width	B - projection
AN	4 1/2"	2 7/8"
DN	4 1/2"	2 1/2"
QN	4 3/4"	3"
SN	4 7/8"	3"

Falcon MA Series is available in several design combinations; "G" Gala rose or "N" Napa escutcheon and "H" Hana knob designation or four levers "A" Avalon, "D" Dane, "Q" Quantum and "S" Sutro. When specifying, example: AN, Avalon (A) lever - with Napa (N) escutcheon.

Lever trim

Cast or forged levers (Avalon, Dane and Quantum) and wrought brass or stainless levers (Sutro), wrought rose and forged or wrought escutcheons are standard.



AG
Avalon-Gala



DG
Dane-Gala



QG
Quantum-Gala



SG
Sutro-Gala

Knob trim

Wrought knobs, wrought roses and forged or wrought escutcheons are standard.



HG
Hana-Gala
Gala - Rose
Hana - Knob

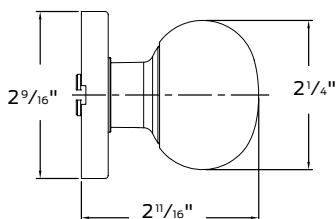

HN
Hana-Napa
N - Escutcheon
H - Knob

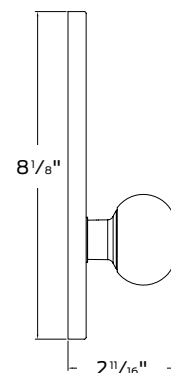

Options and accessories

Trim options



Abrasive coated knobs and levers

All knobs and levers are available with abrasive coating to identify entrances to hazardous areas to the handicapped.

Knurled levers

Levers are available knurled to identify entrances to hazardous areas to the handicapped.

Lead wrapping

MA Series locksets and latchsets are available with lead-wrapping for use on X-ray room doors (or similar situations).

Trim packages

Both knob and lever trim packages are available to allow complete replacement of inner and outer trim on any lock function. Packages include inside and outside trim, spindle and mounting screws. Please see current price book for more details.



Strikes

Manufactured from heavy gauge brass or stainless steel. Meets ANSI Standard A115.1 for frame preparation. Strikes are available with various lip lengths.

Thumb turn/threaded cylinders (sold separately)

Standard thumb turn threaded cylinders for dead bolt operation of MA Series locks may be used in lieu of surface mounted thumb turns. Furnished with A09894-1 cam. Available in length indicated and all MA Series finishes.



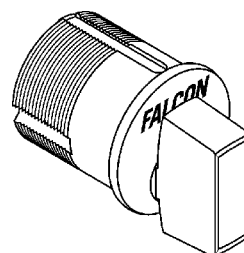





Catalog number	Length
973	1 1/8" RH (turns counter-clockwise)
974	1 1/8" LH (turns clockwise)

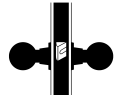

Functions

To order Falcon MA Series locksets, please consult page 17 for ordering information and assistance.









 Indicates interchangeable core available.

Catalog number	ANSI	Function outside/inside	Name	Description
MA101	F 01		Passage or closet latch	Latch bolt operated by knob/lever from either side at all times.
MA161	F 31		Exit or connecting lock	Latch bolt operated by knob/lever from inside. No trim outside. Auxiliary dead latch.
MA301	F 02		Privacy, bedroom/bath	Latch bolt operated by knob/lever from either side. Dead bolt operated by turn from inside and by emergency release from outside.
MA311	F 19		Privacy, bedroom/bath	Latch bolt operated by knob/lever from either side. Dead bolt operated by turn from inside and emergency release from outside. Operating inside knob/lever retracts both bolts.
MA321	F 22		Privacy, bedroom/bath	Latch bolt operated by knob/lever from either side except when outside knob/lever is locked by inside turn. Operating inside knob/lever, closing door or operating outside emergency release unlocks outside knob/lever.
MA371	F 14		Store door lock	Latch bolt operated by knob/lever from either side. Dead bolt operated by key from either side.
MA381	F 09		Apartment, exit	Latch bolt operated by knob/lever from either side, except when outside knob/lever is locked by key from inside. When outside knob/lever is locked, latch bolt is retracted by key from outside or by operating inside lever. Auxiliary dead latch.
MA411	F 30		Asylum or institutional lock	Latch bolt operated by key from either side. Both knobs/levers always inoperative. Auxiliary dead latch.
MA431	F 34		Classroom security with deadbolt	Latch bolt operated by knob/lever from either side except when outside knob/lever is locked from inside or outside by key. Dead bolt retracted by key from inside or outside. Operating inside knob/lever retracts both bolts and unlocks outside. Latch bolt dead locked when dead bolt is thrown.















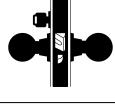

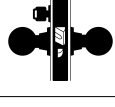



Functions

(continued)

 Indicates interchangeable core available.

Catalog number	ANSI	Function outside/inside	Name	Description
MA441	F 32		Classroom security lock	Latch bolt operated by knob/lever from either side except when outside knob/lever is locked from inside or outside by key. When outside knob/lever is locked, latch bolt is retracted by key from inside or outside or by operating inside knob/lever. Auxiliary dead latch.
MA451	F 15		Hotel guest lock	Latch bolt operated by key from outside or by operating inside knob/lever. Outside knob/lever is always inoperative. Dead bolt projected by turn from inside and all keys except emergency key are shut out. Operating inside knob/lever retracts both bolts. Auxiliary dead latch.
MA521	F 04		Entry/office lock	Latch bolt operated by knob/lever from either side except when outside knob/lever is made inoperative by buttons in face. When outside knob/lever is locked, latch bolt is retracted by key from outside or by operating inside knob/lever. Auxiliary dead latch. Outside knob/lever is unlocked by button on face.
MA531	F 12/ F 20		Apartment corridor door lock	Latch bolt operated by knob/lever from either side, except when outside knob/lever is made inoperative by buttons in face. Dead bolt operated by key outside or turn inside. Key outside operates both bolts. Operating inside knob/lever retracts both bolts and outside remains locked. Latch bolt is deadlocked when outside knob/lever is made inoperative or when the dead bolt is projected. When dead bolt is retracted, knob/lever is unlocked by buttons in face.
MA541	F 21		Room door lock	Latch bolt operated by knob/lever from either side. Dead bolt operated by key from outside or turn from inside.
MA551	F 06		Holdback lock	Latch bolt operated by lever from either side except when outside lever is locked from outside by key. Latch bolt can be locked in a retracted position by key. When outside lever is locked, latch bolt is retracted by key from outside or by operating inside lever unless latch bolt has been locked in a retracted position. Auxiliary dead latch. Note: Chassis is handed. To activate the Holdback Function – from the unlocked position rotate the outside lever/knob to retract the latchbolt. Rotate key 360°. Release lever/knob. To release Holdback Function, rotate key 360° clockwise.
MA561	F 05		Classroom lock	Latch bolt operated by knob/lever from either side except when outside knob/lever is locked from outside by key. When outside knob/lever is locked, latch bolt is retracted by key from outside, or by operating inside knob/lever. Auxiliary dead latch deadlocks latchbolt when door is closed. Inside knob/lever always free for immediate exit.
MA571	F 13		Dormitory or exit lock	Latch bolt operated by knob/lever from either side. Dead bolt projected by key from outside and turn from inside. Operating inside knob/lever retracts both bolts and unlocks outside.
MA581	F 07		Storeroom lock	Latch bolt operated by key from outside or by operating inside knob/lever. Outside knob/lever is always inoperative. Auxiliary dead latch.

 Indicates interchangeable core available.

Catalog number	ANSI	Function outside/inside	Name	Description
MA621	F 08/ F 10	 	Front door apartment corridor	Latch bolt is operated by knob/lever from either side, except when outside knob/lever is made inoperative by buttons in face. Dead bolt is operated by turn inside. Key outside operates both bolts. Outside knob/lever is unlocked by button on face.
MA641	NA	 	Dormitory lock	Latch bolt by knob/lever inside and key outside. Inside knob/lever free. Outside knob/lever rigid. Deadbolt by key outside or T-turn inside. Rotating inside knob/lever retracts both bolts. Deadlocking latch.
MA851	NA	 	Storeroom-fail safe (EL - 12 & 24 VDC)	Latch bolt operated by knob/lever from either side except when outer knob/lever is electrically locked. When outer knob/lever is locked, latch bolt retracted by key in cylinder outside. Deadlocking latch.
MA881	NA	 	Storeroom-fail secure (EU - 12 & 24 VDC)	Latch bolt operated by knob/lever from inside except when outer knob/lever is electrically unlocked, then latch bolt from either side. When locked, key in cylinder outside retracts latch bolt. Deadlocking latch.
MA911	F 29	 	Classroom dead lock	Key from outside operates dead bolt. Turn from inside retracts but does not project dead bolt.
MA921	F 18	 	Dead lock	Dead bolt operated by key from outside only.
MA931	F 16	 	Dead lock	Dead bolt operated by key from either side.
MA941	F 17	 	Dead lock	Dead bolt operated by key from outside and by turn from inside.
MA12	NA	 	Single dummy	Single dummy trim
MA18	NA	 	Double dummy	Double dummy trim

Interchangeable cores

Mortise cylinders

All Falcon MA Series keyed locks are available with mortise cylinders that will accept Falcon small format interchangeable cores (SFIC) as well as some other manufacturers' SFIC. Interchangeable core cylinders are available in 6- or 7-pin configurations, for increased security by quick change of keying. Interchangeable core cylinders allow the capability of immediately changing the keying on any door without the necessity of disassembling the lock. The core is removed by use of a special "control" key. Rotating the key to the right and gently pulling will disengage the core from the housing. The replacement core is then inserted and the control key rotated to the left to "lock" the core in place and the control key is removed.

To order: Falcon mortise locks with interchangeable cores, add "G" 6- or 7-pin in detail area of order.

To order: Falcon mortise locks for interchangeable core, less core (SFIC), add "B" 6- or 7-pin in detail area of order.

Interchangeable core MA Series function/cam chart

Catalog number	Outside cam no.	Inside cam no.
MA371	5622-IC	5622-IC
MA381	5621-IC	5620-IC
MA411	5622-IC	5622-IC
MA431	5622-IC	5622-IC
MA441	5622-IC	5622-IC
MA451	5622-IC	
MA521	5622-IC	
MA531	5622-IC	
MA541	5622-IC	
MA551	5622-IC	
MA561	5622-IC	
MA571	5622-IC	
MA581	5622-IC	
MA621	5622-IC	
MA641	5622-IC	
MA851	5622-IC	
MA881	5622-IC	
MA911	5622-IC	
MA921	5622-IC	
MA931	5622-IC	5622-IC
MA941	5622-IC	

Cam numbers
 5622-IC = interchangeable cam
 5620-IC = F09 Interchangeable Inside
 5621-IC = F09 interchangeable Outside



All keyed cylinders are supplied with two nickel silver keys.

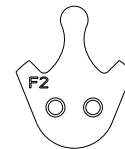
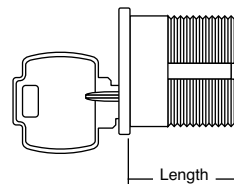

5622-IC

Catalog number	Length
Standard cylinders	
C987	1 ³ / ₈ "
C988	1 ¹ / ₂ "
C990	1 ³ / ₄ "
C992	2"
Hotel/motel cylinders	
C261	1 ¹ / ₂ " RH
C262	1 ⁵ / ₈ " RH
C264	1 ¹ / ₂ " LH
C265	1 ⁵ / ₈ " LH

Special hotel/motel cylinders furnished with cam A12667-007-00.

Note: To order the cylinder housing only, order by listing catalog number for required length and cam number as indicated in the chart. Also specify finish and pin condition.

Example: No. C987 with A12667-003-00, 626, for 7-pin interchangeable core.

Standard cylinders

Mortise cylinders

Only the finest materials are used in the manufacture of our cylinders. Modern equipment and gauging ensure consistent, reliable production of our entire line of cylinders. We offer a full and complete line of spacer rings, cylinder guards and spring washers, as well as numerous cams to fulfill the requirements of most applications. Standard mortise cylinders are furnished as 5- or 6-pin as standard. 7-pin cylinders are available. All keyed cylinders are supplied with two nickel silver keys.

Standard core MA Series function/cam chart

Catalog number	Outside cam no.	Inside cam no.
MA371	5622	5622
MA381	5621	5620
MA411	5622	5622
MA431	5622	5622
MA441	5622	5622
MA451	5622	
MA521	5622	
MA531	5622	
MA541	5622	
MA551	5622	
MA561	5622	
MA571	5622	
MA581	5622	
MA621	5622	
MA641	5622	
MA851	5622	
MA881	5622	
MA911	5622	
MA921	5622	
MA931	5622	5622
MA941	5622	

Cam numbers
 5622 = standard cam
 5620 = F09 standard inside
 5621 = F09 standard outside

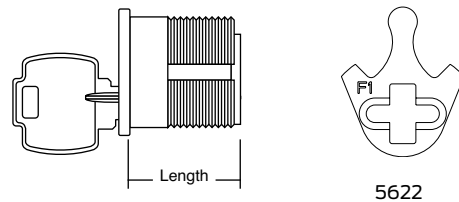

Catalog number	Length	
Standard cylinders		
985	1 1/8"	
987	1 3/8"	
988	1 1/2"	
990	1 3/4"	
992	2"	
Hotel/motel cylinders		
250	1 1/8" RH	6-pin
251	1 1/4" RH	6-pin
252	1 3/8" LH	6-pin
253	1 3/8" LH	7-pin

Special hotel/motel cylinders, furnished with cam A09894-001-00.

Note: To order cylinder separately, order by listing catalog number for required length and cam number as indicated in chart above. Also, specify finish and number of pins.

Example: 986 with A09897-000-00, 626, 6-pin

Cylinder guards

Falcon offers two different types of cylinder guards in various thicknesses to work with sectional or escutcheon trim, different door ranges and various cylinder lengths. Our standard cylinder, 985, is 1 1/8" long. The factory will furnish the correct cam(s) and cylinder guard for the function and door thickness specified. The A08790 and A08794 cylinder guards in bar stock brass are available to accommodate different cylinder lengths and door thicknesses as shown.

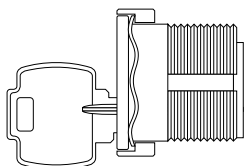

985 cylinder with
A08790 cylinder guard.

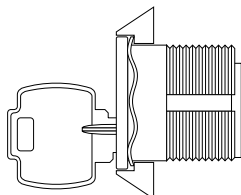

985 cylinder with
A08794 cylinder guard.



A08790



A08794

Escutcheon trim ring

Door thickness	Function	985 1 1/8"	986 1 1/4"	(c)987 1 3/8"	(c)988 1 1/2"
1 1/2"	Single cylinder	—	A08790-000	A08790-001	A08790-002
1 1/2"	Double cylinder	A08790-000	—	—	—
1 3/4"	Single cylinder	—	—	A08790-000	A08790-001
1 3/4"	Double cylinder	—	A08790-000	A08790-001	A08790-002
2"	Single cylinder	—	—	A08790-000	A08790-001
2"	Double cylinder	—	—	A08790-000	A08790-001
2 1/4"	Single cylinder	—	—	—	A08790-000
2 1/4"	Double cylinder	—	—	—	—
2 1/2"	Single cylinder	—	—	—	—
2 1/2"	Double cylinder	—	—	—	—

Sectional trim ring

Door thickness	Function	985 1 1/8"	986 1 1/4"	(c)987 1 3/8"	(c)988 1 1/2"
1 1/2"	Single cylinder	A08794-001	A08794-002	—	—
1 1/2"	Double cylinder	A08794-002	A08794-003	—	—
1 3/4"	Single cylinder	A08794-000	A08794-001	A08794-002	—
1 3/4"	Double cylinder	A08794-001	A08794-002	A08794-003	—
2"	Single cylinder	—	A08794-000	A08794-001	A08794-002
2"	Double cylinder	A08794-000	A08794-001	A08794-002	A08794-003
2 1/4"	Single cylinder	—	—	A08794-000	A08794-001
2 1/4"	Double cylinder	—	A08794-000	A08794-001	A08794-002
2 1/2"	Single cylinder	—	—	—	A08794-000
2 1/2"	Double cylinder	—	—	A08794-000	A08794-001

Specify part number and finish when ordering. (e.g. A08790-000-626)

**Single cylinder functions

Cylinder guards

(continued)

Rim cylinder tailpieces

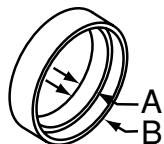

Dim. A	Dim. B	Part No.
$\frac{3}{32}$ "	$\frac{9}{32}$ "	A08790-000
$\frac{7}{32}$ "	$\frac{13}{32}$ "	A08790-001
$\frac{11}{32}$ "	$\frac{17}{32}$ "	A08790-002
$\frac{15}{32}$ "	$\frac{21}{32}$ "	A08790-003
$\frac{43}{64}$ "	$\frac{55}{64}$ "	A08790-004

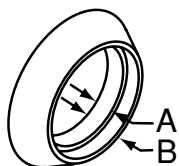

Dim. A	Dim. B	Part No.
$\frac{3}{32}$ "	$\frac{9}{32}$ "	A08794-000
$\frac{7}{32}$ "	$\frac{13}{32}$ "	A08794-001
$\frac{11}{32}$ "	$\frac{17}{32}$ "	A08794-002
$\frac{15}{32}$ "	$\frac{21}{32}$ "	A08794-003

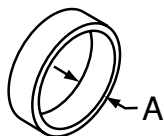

Dim. A	Dim. B	Part No.
$\frac{1}{8}$ "	—	008876-000
$\frac{3}{16}$ "	—	008876-005
$\frac{1}{4}$ "	—	008876-001
$\frac{3}{8}$ "	—	008876-002
$\frac{1}{2}$ "	—	008876-003
$\frac{5}{8}$ "	—	008876-004

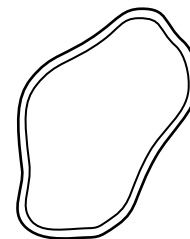

Wave washer included.

To order separately. Specify
008789-001-60

Conversion chart

MA Series Grade 1 mortise locks

ANSI No./ Grade	Function	Falcon	Arrow	Best	Cal-royal	Corbin/Russwin	Dorma	Marks	Sargent	Yale
F 01	MA101	Passage or closet latch	A-B01	45N	M8010	ML2010	9010	5-55N	8215	8801
F 02	MA301	Privacy, bedroom/bath	-	45LB	M8040	ML2020	-	5-55L	8268	-
F 04	MA521	Entry lock	A-B22	45A	M8050	ML2051	9050	5-55E	8205	8807
F 05	MA561	Classroom lock	A-B17	35R	M8070	ML2055	9070	5-55J	8237	8808
F 06	MA551	Holdback lock	-	45RHB	-	ML2056	9076	5-55JM/JR	8289	8824
F 07	MA581	Storeroom/closet lock	A-B12	45ED	M8080	ML2057	9080	5-55EW	8204	8805
F 08/F 10	MA621	Front door/apartment corridor	A-B21	45BA	-	ML2048	-	5-55A	8247	8747
F 09	MA381	Apartment, exit	A-B32	45C	M8060	ML2042	9060	5-55G	8216	8817-2
F12/F 20	MA531	Apartment corridor door lock	A-B20	45AB	M8453	ML2067	9953	5-55FD	8243	8847
F 13	MA571	Dormitory or exit lock	A-B19	45FT	M8456	ML2065	9956	5-55FW	8225	8822
F 14	MA371	Store door lock	A-B31	45G	M8466	ML2022	9966	5-55C	8226	8860-2
F 15	MA451	Hotel guest lock	A-B15 /16	45H/HJ	-	ML2029	9985	5-55H	8250	8820
F 16	MA931	Dead lock	A-B42	45WD	-	ML2012	9962	5-55T	8222	8814-2
F 17	MA941	Dead lock	A-B41	45AD	-	ML2013	9960	5-55P	8221	8815
F 18	MA921	Dead lock	A-B40	45YD	-	ML2011	9961	5-55S	8220	8814
F 19	MA311	Privacy, bedroom/bath	A-B02	45L	M8040	ML2030	9940	5-55LF	8266	8802
F 21	MA541	Room door lock	A-B13	45B	M8473	ML2024	9973	5-55B	8224	8860
F 22	MA321	Privacy, bedroom/bath	A-B26	-	M8040	ML2060	9040	5-55LJ	8265	8862
F 29	MA911	Classroom dead lock	-	45RD	-	-	9963	5-55SC	8203	8813ST
F 30	MA411	Asylum or institutional lock	A-B33	45W	-	-	9082	5-55WW	8217	8830-2
F 31	MA161	Exit or communicating lock	-	45Y	-	-	9025	5-55EX	8213	8828
F 32	MA441	Intruder latch bolt lock	A-B37	45INL	-	ML2052	9071	5-55GC	8238	8808-2
F 34	MA431	Intruder dead bolt lock	-	-	-	-	9967	-	8240	8812-2
NA	MA12	Single dummy	-	451DT	M8170	ML2050	-	-	8293	855/855FL
NA	MA18	Double dummy	-	452DT	-	ML2070	-	-	8294	836B/838FL
NA	MA851	Storeroom-fail safe (EL - 12 & 24 VAC or VDC)	A-B17-177	45EWEL	-	ML20903	9080EL	5-55EL	8270	8880
NA	MA881	Storeroom-fail secure (EU - 12 & 24 VAC or VDC)	A-B17-178	45EWEU	-	ML20905	9080EU	5-55EU	8271	8881
NA	MA641	Dormitory lock	-	45FD	-	-	-	-	-	-

All effort has been made to make this information comprehensive. Since no two products are exactly alike, this data represents those products which are similar. This information was obtained from trade services and is not guaranteed nor meant to represent any product as equal to any other product.

Construction keying

Falcon offers two different construction key systems depending on the size of and application within the project. Both systems permit the installation and use of regular door locks during construction, yet completely preserve the security of the keying system for the ultimate building owner. The Master, Grand Master and change keys are never with the locks during the construction phase of a building. Only the “construction” keys are sent to the job site. Where the job permits, we will utilize the “Lost pin system” as our standard system for construction keying. Larger or more complicated jobs may require the use of our “Blockokey® System” for construction keying.

“Disposable construction” interchangeable cores

This newly designed disposable construction core (1408) is an inexpensive alternative to interior keyed construction cores. This core should be used on interior door applications or where security on a site is not a concern. No keys need to be issued. The disposable core is inserted in the lever or knob and is operated by a thumb turn, which retracts the latch bolt. Please use either brass or permanent construction cores on exterior doors or secured areas.

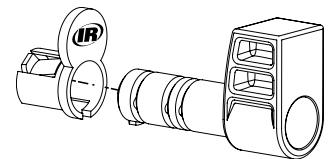

Locks with “Lost pin system”

Our “lost” pin construction key system consists of one construction pin and a shallow hole in the side of the plug.

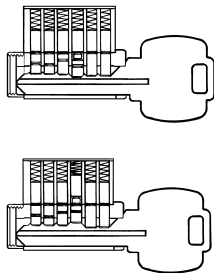

Construction key—KB566

When the “construction” key is used, the construction pin is always in the cylinder plug, sitting on top of the bottom pin.

Master key—KB578

When the Master key is inserted, the construction pin is pushed up into the cylinder housing. As the Master key is rotated to the right, the construction pin will drop into the hole in the plug, thereby eliminating any future use of the construction key.

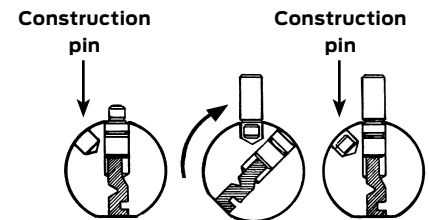

Locks with Blockokey® cylinders

All lock cylinders on a specific project are operable by a special “project key.” Duplicates of this key may be assigned by the building contractor to workmen and subcontractors as required. No regular change keys or Master keys are needed on the job. This eliminates the possibility of subsequent exposure from lost or stolen keys.

How to order locks with Blockokey® cylinders

Blockokey® locksets are ordered by adding the word “Blockokey” after the balance of the ordering information.

Example: 72 Each B511 D 626 1AA-72AA (Blockokey)

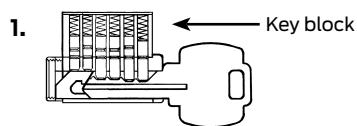

Project key—KB531

Lock cylinder is operated by the special “project key.” The last two pins in the cylinder are held inoperative by the key block.

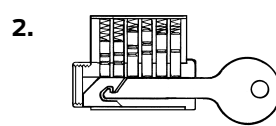

Removal tool – KB536

The special “project key” is canceled out by removal of the key block. A key block removal tool is furnished with the Master keys for the locks. Simply push the removal tool into the keyway, then withdraw it to remove the block. Thereafter, the “project key” will no longer operate the lock cylinder.

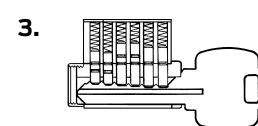

Change or master key—KB578

Cylinder is now only operable by the regular change key or Master key.

How to order

For correct ordering, and to ensure no delays in shipment of your order, the following descriptive data must be listed in the sequence shown. Necessary information can be found in other parts of this catalog. The example below shows an order for 16 each MA locksets in the 521 Entry function, DG (Dane-Gala) trim design in a 626 (satin chrome) finish, 8 RH (right hand) and 8 LH (left hand) to accommodate doors 1 3/4" thick with AA1-AA16 keying.

- **Quantity:** Indicate the quantity required.
- **Catalog number:** Select catalog number.
- **Trim design:** Indicate letter of knob or lever design followed by letter of rose or escutcheon design.
 - Example: DG-D for Dane lever followed by G for Gala rose.
- **Finish:** When the finish is the same for the outside and inside trim, it is shown once (626). Outside finish always precedes inside finish on split finishes (605 x 625).
- **Latches:** Two-piece mechanical anti-friction standard. All catalog numbers shown in this catalog indicate 2 3/4" backset.
- **Strikes:** 4 7/8" x 1 1/4" x 1 5/16" lip-to-center with curved lip standard. Optional strikes with shorter or longer lip lengths available.
- **Cylinder type:** For 6-pin, add 6-pin. For 7-pin, add 7-pin.
- **Door hand:** See chart.
- **Keying detail:** We suggest using the standard terms developed by the A.H.C. (consult factory).
 - Example: AA1 - Grand Master keyed, Master keyed, change key 1.
- **Interchangeable core:** To order product capable of accepting an interchangeable core, add "B" less SFIC (for interchangeable core). To order product with an interchangeable core, add "SFIC" (with interchangeable core).
 - Example: "G" with Falcon SFIC core.
- **Keyways:** "G" is standard on regular cylinders, "A" is standard on interchangeable cores. Other keyways available. See price book.
- **Additional keys:** Note the total number of keys required.
- **Large bow keys:** Add—"with large bow keys".

How to order example

Qty.	Catalog number	Trim design	Finish	Latch	Strike	Cylinder	Door hand				Detail
							RH	LH	RHR	LHR	
8	MA521P	DG	626	Std	Std	6-pin	X				AA1-AA8 1 3/4" DR
8	MA521P	DG	626	Std	Std	6-pin		X			AA9-AA16 1 3/4" DR

Finishes

The latest in modern techniques and equipment are used to apply the highest quality finish. Extra steps assure durable, consistent finishes and long useful life.

Although we apply the finest available protective plating and/or enamel coating to the surface of our products, these finishes have limitations and in time may deteriorate either from exposure to weather, pollution, perspiration, extremes

of climate, frequency of use or other factors.

Deterioration of these finishes is, therefore, not a defect, but a normal process which is unavoidable. Our company cannot accept responsibility for finish deterioration in these circumstances, and therefore the finishes cannot be guaranteed. These products will not be refinished or replaced under our warranty should deterioration of finishes occur.

Trim finishes chart

Description	ANSI No.	Available on
Bright brass	605	All trim
Satin brass	606	All trim
Oil rubbed bronze	613	All trim
Bright chrome	625	All trim
Satin chrome	626	All trim
Satin stainless steel	630	All trim

Product identification

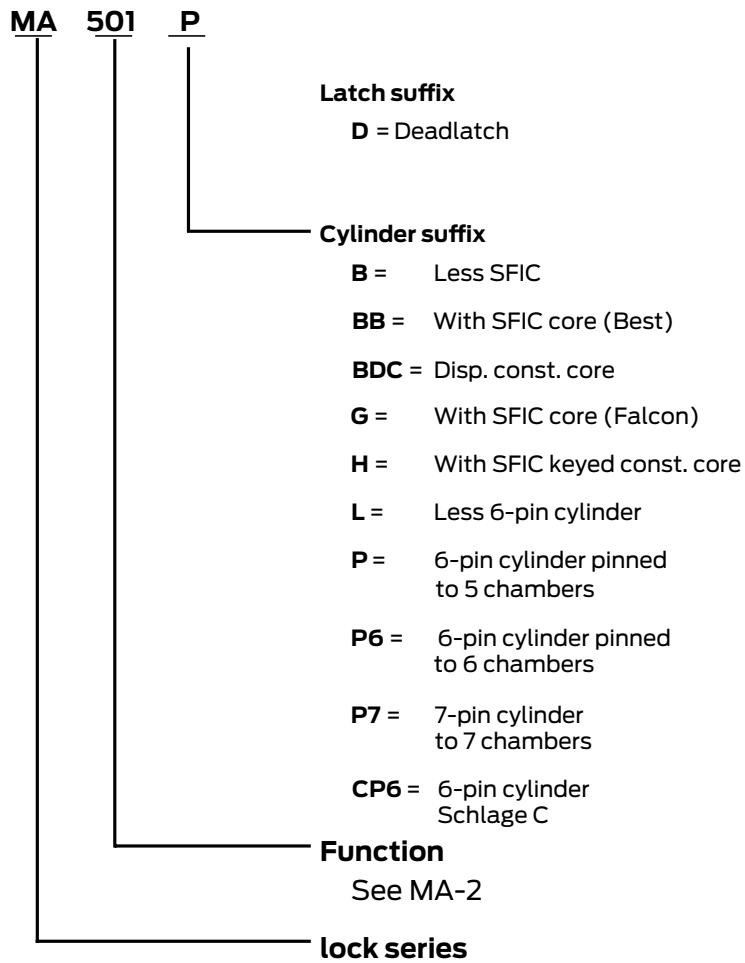

SFIC = Small format (Best® style) interchangeable core

How to determine the hand of a door

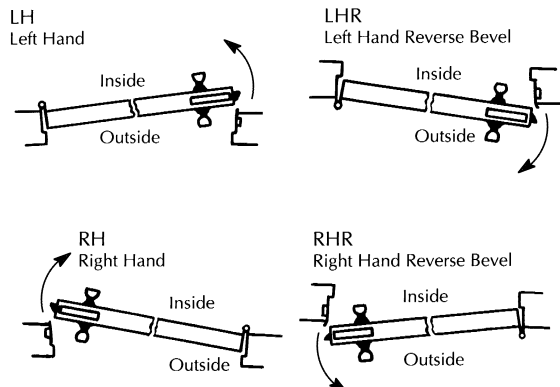

About Allegion

Allegion (NYSE: ALLE) creates peace of mind by pioneering safety and security. As a \$2 billion provider of security solutions for homes and businesses, Allegion employs more than 8,000 people and sells products in more than 120 countries across the world. Allegion comprises 27 global brands, including strategic brands CISA®, Interflex®, LCN®, Schlage® and Von Duprin®.

For more, visit www.allegion.com

aptiQ ■ LCN ■ **SCHLAGE** ■ STEELCRAFT ■ VON DUPRIN