

INSTRUCTIONS FOR INSTALLING 3828 SERIES RIM EXIT DEVICE

US PATENT No 268003
CANADIAN PATENT No RD1981

SARGENT
ASSA ABLOY

CAUTION!

BEFORE STARTING:

- INSTALL MULLION IF USED;
- DOOR SHOULD BE FITTED AND HUNG;
- CHECK BOX LABEL FOR SIZE OF EXIT DEVICE.

AVAILABLE STOCK LENGTHS:

- LENGTH "E" - 32" DOOR, NO CUT REQUIRED.
CAN BE CUT TO FIT DOORS DOWN TO 24" WIDE.
- LENGTH "F" - 36" DOOR, NO CUT REQUIRED.
CAN BE CUT TO FIT DOORS DOWN TO 30" WIDE.
- LENGTH "G" - 48" DOOR, NO CUT REQUIRED.
CAN BE CUT TO FIT DOORS DOWN TO 36" WIDE.

IMPORTANT:

- FOR RIM CYLINDER APPLICATIONS:
INSTALL CYLINDER TAIL WASHER TO CYLINDER TAIL PIECE. SEE STEP THREE FOR DETAILS.
- CLEAR AWAY ANY RAISED PROJECTIONS TO ALLOW EXIT DEVICE TO REST ON FLAT SURFACE OF THE DOOR.

CYLINDER TAIL WASHER

END CAP

MOUNTING BRACKET

"LOCK DOWN KEY"
TO OPERATE: DEPRESS PUSHRAIL;
INSERT HEX KEY AND TURN CLOCKWISE.

RAIL ASSEMBLY

HORIZONTAL REFERENCE LINE
(ϕ OF CHASSIS AND RAIL ASSEMBLY)

641 STRIKE SHOWN

CENTER CHASSIS ASSEMBLY

VERTICAL REFERENCE LINE
(ϕ OF CHASSIS)

THIS EXIT DEVICE IS NON-HANDED

OUT

RIGHT HAND REVERSE BEVEL

LEFT HAND REVERSE BEVEL

FIRST

A MARK VERTICAL AND HORIZONTAL REFERENCE LINES ON THE DOOR

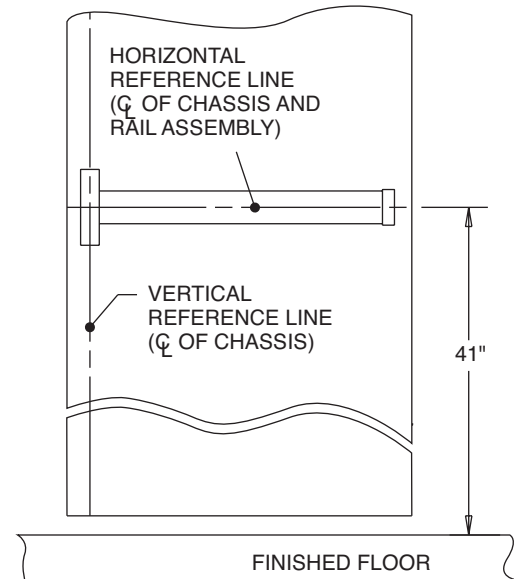

B IDENTIFY TYPE OF INSTALLATION TO DETERMINE LOCATION OF VERTICAL ϕ

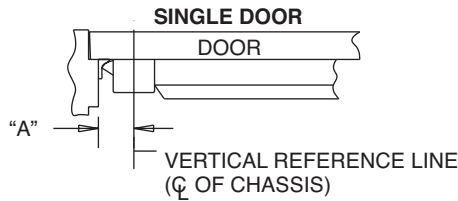

IF USE 641 STRIKE DIM. "A"=2-1/4"

IF USE 613 STRIKE DIM. "A"=1-3/4"

IF USE 642 STRIKE DIM. "A"=1-1/2"

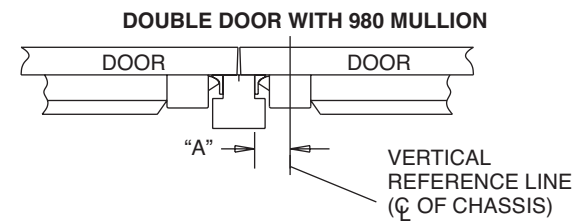

IF USE 641 STRIKE DIM. "A"=2 1/4"

SECOND

PREPARE DOOR

APPLY TEMPLATE ON THE DOOR ALONG REFERENCE LINES AND TAPE IT WITH SUPPLIED TAPE. IF DOOR ALREADY HAS ANSI DOOR PREP (161 CUT-OUT), OR HAS 2 1/8" DIA HOLE AT 2 3/4" BACKSET, POSITION TEMPLATE OVER EXISTING HOLE & MARK FOR 4 CHASSIS MOUNTING HOLES.

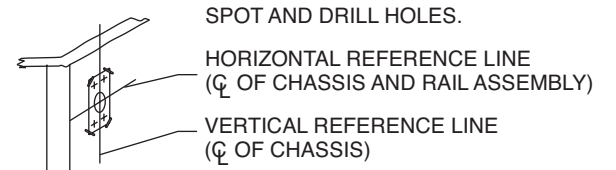

THIRD

APPLY HARDWARE

K-HTB APPLICATIONS

THRUBOLT OUTSIDE TRIM (IF USED) TO CHASSIS

WHEN CYLINDER IS USED - IT MUST BE POSITIONED IN THE MIDDLE OF TRIM, AS ILLUSTRATED

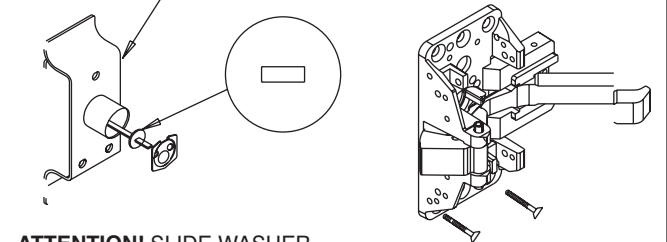

ATTENTION! SLIDE WASHER OVER THE CYLINDER TAIL BEFORE BACK PLATE INSTALLATION

FOR RIM CYLINDER ONLY APPLICATION

ATTENTION: USE STANDARD SHIMS FOR CENTER CHASSIS MOUNTING

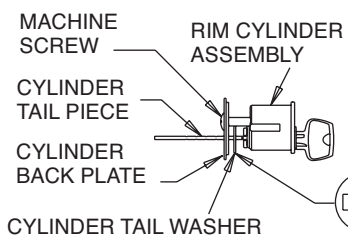

ATTENTION: SLIDE CYLINDER TAIL WASHER OVER THE CYLINDER TAIL PIECE BEFORE ATTACHING CYLINDER BACK PLATE TO THE DOOR

KNOB TRIM APPLICATIONS

- TRIM IS NON HANDED.
- SCREW THE ROSE DOWN ALL THE WAY.
 - WITH KEYHOLE FACING DOWN, POSITION TRIM IN CROSS BORE HOLE, AND ATTACH TO CHASSIS WITH (2) #10-32 FILLISTER HD. MACHINE SCREWS.

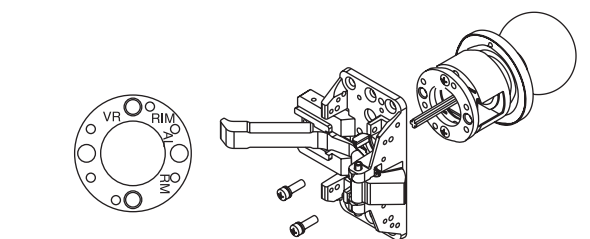

**FOR LEVER TRIM APPLICATIONS, SEE INSTRUCTION SHEET A7274 PACKED WITH LEVER TRIM.

FOURTH

APPLY RAIL ASSEMBLY

- CHECK BOX LABEL. IF CUTTING IS NOT REQUIRED PROCEED TO STEP "B".
- IF CUTTING IS REQUIRED, CONTINUE WITH STEP "A".

A DETERMINE CUT OFF DIMENSION "X" BY SUBTRACTING 2" FROM DIMENSION "Y". MARK CUT OFF POINT ON MOUNTING RAIL.

FOR DOORS WITH STILE RAIL MUST OVERLAP STILE BY 1/2" MIN.

VERTICAL REFERENCE LINE
(ϕ OF CHASSIS)

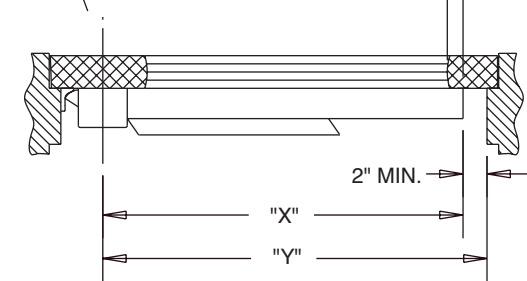

HOLD DOWN PUSH RAIL, CUT OFF AND DEBURR.

CAUTION: DO NOT CUT CLOSER THAN 3-1/2" FROM THE CONNECTING ARM PIVOT IN THE PUSH RAIL

PLACE MOUNTING PLATE TIGHT AGAINST RAIL AND ATTACH IT TO THE DOOR WITH #10 ROUND HEAD SCREWS

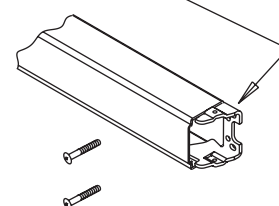

B DEPRESS ARM INTO RAIL OPENING AND SLIDE RAIL ONTO CHASSIS. LEVEL RAIL AND FASTEN MOUNTING PLATE

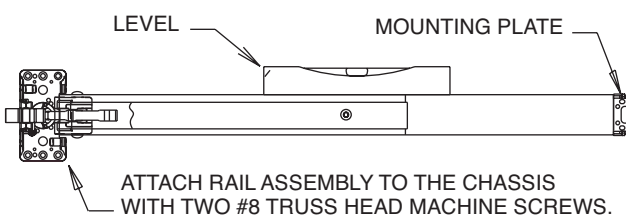

FIFTH

APPLY COVERS AND STRIKE

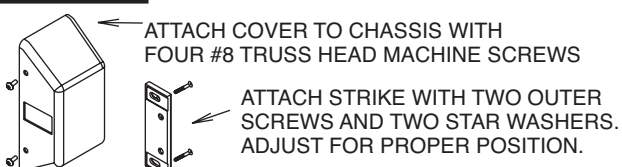

ATTACH END CAP TO MOUNTING PLATE WITH TWO COVER SCREWS



FOR EXIT ONLY APPLICATIONS

USING RETAINING RING PLIERS (NOT SHOWN) OR SCREWDRIVER TO REMOVE RETAINING RING FROM THE CAM AND CAM FROM THE CENTER CHASSIS ASSEMBLY FOR FLUSH MOUNTING.

ATTACH CHASSIS WITH FOUR #10 WOOD OR MACHINE SCREWS

RETAINING RING

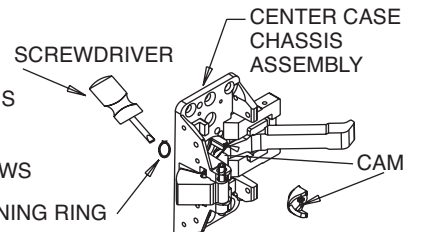

INSTRUCTIONS FOR INSTALLING 12-3828 SERIES RIM FIRE EXIT DEVICE

US PATENT No 268003
CANADIAN PATENT No RD1981

SARGENT
ASSA ABLOY

CAUTION!

BEFORE STARTING:

- INSTALL MULLION IF USED;
- DOOR SHOULD BE FITTED AND HUNG;
- CHECK BOX LABEL FOR SIZE OF EXIT DEVICE.

AVAILABLE STOCK LENGTHS:

- LENGTH "E" - 32" DOOR, NO CUT REQUIRED.
CAN BE CUT TO FIT DOORS DOWN TO 24" WIDE.
- LENGTH "F" - 36" DOOR, NO CUT REQUIRED.
CAN BE CUT TO FIT DOORS DOWN TO 30" WIDE.
- LENGTH "G" - 48" DOOR, NO CUT REQUIRED.
CAN BE CUT TO FIT DOORS DOWN TO 36" WIDE.

IMPORTANT:

- FOR RIM CYLINDER APPLICATIONS:
INSTALL CYLINDER TAIL WASHER TO CYLINDER TAIL PIECE. SEE STEP THREE FOR DETAILS.
- CLEAR AWAY ANY RAISED PROJECTIONS TO ALLOW EXIT DEVICE TO REST ON FLAT SURFACE OF THE DOOR.



CYLINDER TAIL WASHER

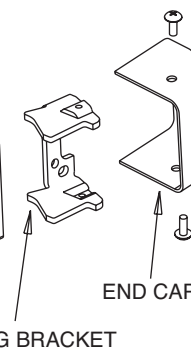

END CAP

MOUNTING BRACKET

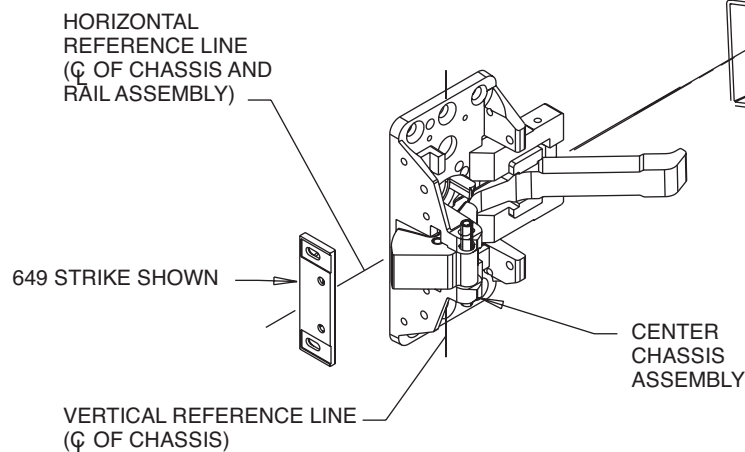

HORIZONTAL REFERENCE LINE (C OF CHASSIS AND RAIL ASSEMBLY)

RAIL ASSEMBLY

CENTER CHASSIS ASSEMBLY

649 STRIKE SHOWN

VERTICAL REFERENCE LINE (C OF CHASSIS)

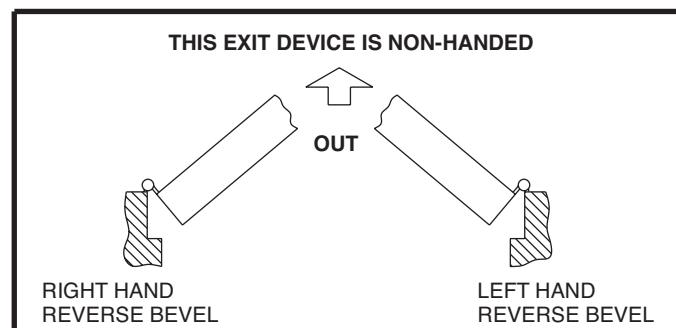

THIS EXIT DEVICE IS NON-HANDED

OUT

RIGHT HAND REVERSE BEVEL

LEFT HAND REVERSE BEVEL

FIRST A MARK VERTICAL AND HORIZONTAL REFERENCE LINES ON THE DOOR

B IDENTIFY TYPE OF INSTALLATION TO DETERMINE LOCATION OF VERTICAL C

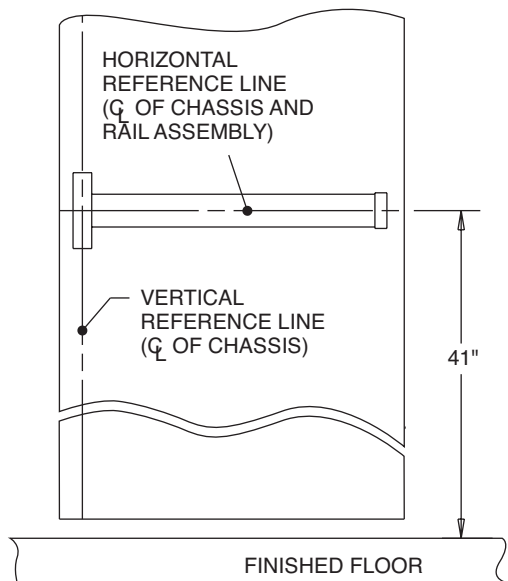

HORIZONTAL REFERENCE LINE (C OF CHASSIS AND RAIL ASSEMBLY)

VERTICAL REFERENCE LINE (C OF CHASSIS)

41"

FINISHED FLOOR

SINGLE DOOR

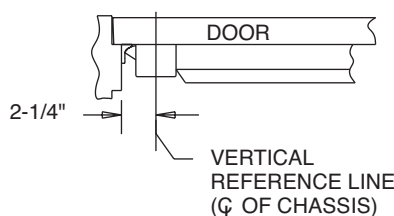

DOOR

2-1/4"

VERTICAL REFERENCE LINE (C OF CHASSIS)

DOUBLE DOOR WITH 12-980 MULLION

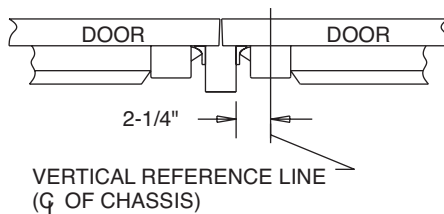

DOOR

2-1/4"

VERTICAL REFERENCE LINE (C OF CHASSIS)

FOURTH APPLY RAIL ASSEMBLY

- CHECK BOX LABEL. IF CUTTING IS NOT REQUIRED PROCEED TO STEP "B".
- IF CUTTING IS REQUIRED, CONTINUE WITH STEP "A".

A DETERMINE CUT OFF DIMENSION "X" BY SUBTRACTING 2" FROM DIMENSION "Y". MARK CUT OFF POINT ON MOUNTING RAIL.

FOR DOORS WITH STILE RAIL MUST OVERLAP STILE BY 1/2" MIN.

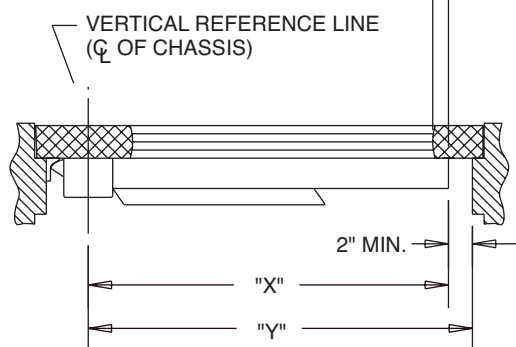

VERTICAL REFERENCE LINE (C OF CHASSIS)

2" MIN.

"X"

"Y"

HOLD DOWN PUSH RAIL, CUT OFF AND DEBURR.

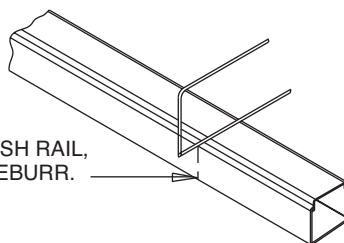

CAUTION: DO NOT CUT CLOSER THAN 3-1/2" FROM THE CONNECTING ARM PIVOT IN THE PUSH RAIL

PLACE MOUNTING PLATE TIGHT AGAINST RAIL AND ATTACH IT TO THE DOOR WITH #10 ROUND HEAD SCREWS

B DEPRESS ARM INTO RAIL OPENING AND SLIDE RAIL ONTO CHASSIS. LEVEL RAIL AND FASTEN MOUNTING PLATE

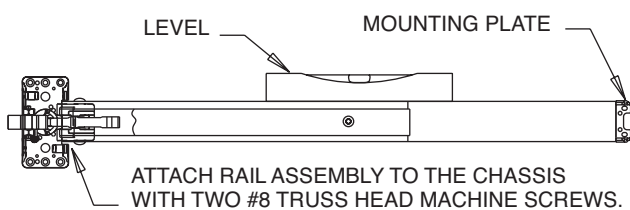

LEVEL

MOUNTING PLATE

ATTACH RAIL ASSEMBLY TO THE CHASSIS WITH TWO #8 TRUSS HEAD MACHINE SCREWS.

ATTACH END CAP TO MOUNTING PLATE WITH TWO COVER SCREWS



ATTACH STRIKE WITH TWO STRIKE SCREWS AND ADJUST FOR PROPER POSITION. DRILL AND TAP TWO ADDITIONAL HOLES AND FASTEN STRIKE IN PLACE

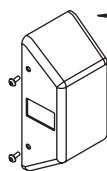

ATTACH COVER TO CHASSIS WITH FOUR #8 TRUSS HEAD MACHINE SCREWS

SECOND PREPARE DOOR

APPLY TEMPLATE ON THE DOOR ALONG REFERENCE LINES AND TAPE IT WITH SUPPLIED TAPE. IF DOOR ALREADY HAS ANSI DOOR PREP (161 CUT-OUT), OR HAS 2-1/8" DIA HOLE AT 2-3/4" BACKSET, POSITION TEMPLATE OVER EXISTING HOLE & MARK FOR 4 CHASSIS MOUNTING HOLES.

SPOT AND DRILL HOLES.

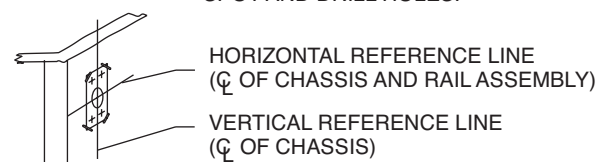

HORIZONTAL REFERENCE LINE (C OF CHASSIS AND RAIL ASSEMBLY)

VERTICAL REFERENCE LINE (C OF CHASSIS)

THIRD APPLY HARDWARE

K-HTB APPLICATIONS

THRUBOLT OUTSIDE TRIM (IF USED) TO CHASSIS

WHEN CYLINDER IS USED - IT MUST BE POSITIONED IN THE MIDDLE OF TRIM, AS ILLUSTRATED

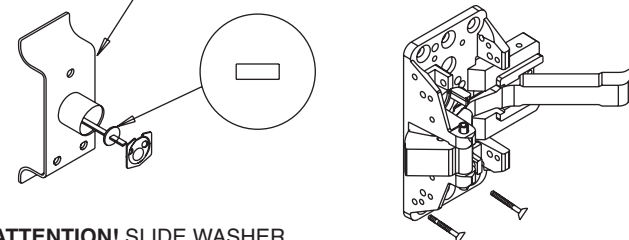

ATTENTION! SLIDE WASHER OVER THE CYLINDER TAIL BEFORE BACK PLATE INSTALLATION

FOR RIM CYLINDER ONLY APPLICATION

ATTENTION: USE STANDARD SHIMS FOR CENTER CHASSIS MOUNTING

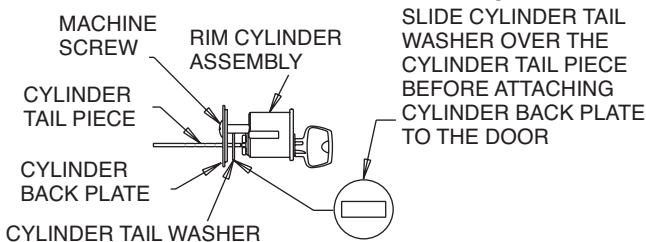

MACHINE SCREW

RIM CYLINDER ASSEMBLY

CYLINDER TAIL PIECE

CYLINDER BACK PLATE

CYLINDER TAIL WASHER

ATTENTION: SLIDE CYLINDER TAIL WASHER OVER THE CYLINDER TAIL PIECE BEFORE ATTACHING CYLINDER BACK PLATE TO THE DOOR

KNOB TRIM APPLICATIONS

TRIM IS NON HANDED.
1. SCREW THE ROSE DOWN ALL THE WAY.
2. WITH KEYHOLE FACING DOWN, POSITION TRIM IN CROSS BORE HOLE, AND ATTACH TO CHASSIS WITH (2) #10-32 FILLISTER HD. MACHINE SCREWS.

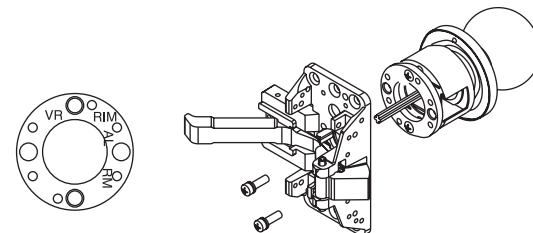

**FOR LEVER TRIM APPLICATIONS, SEE INSTRUCTION SHEET A7274 PACKED WITH LEVER TRIM.

FIFTH APPLY COVERS AND STRIKE

FOR EXIT ONLY APPLICATIONS

USING RETAINING RING PLIERS (NOT SHOWN) OR SCREWDRIVER TO REMOVE RETAINING RING FROM THE CAM AND CAM FROM THE CENTER CHASSIS ASSEMBLY FOR FLUSH MOUNTING.

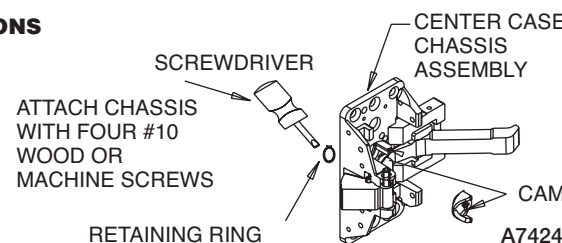

ATTACH CHASSIS WITH FOUR #10 WOOD OR MACHINE SCREWS

RETAINING RING

CENTER CASE CHASSIS ASSEMBLY

CAM

A7424D